

Your Favorite Products, *One Powerful Brand*

# Showdown<sup>®</sup>

DISPLAYS

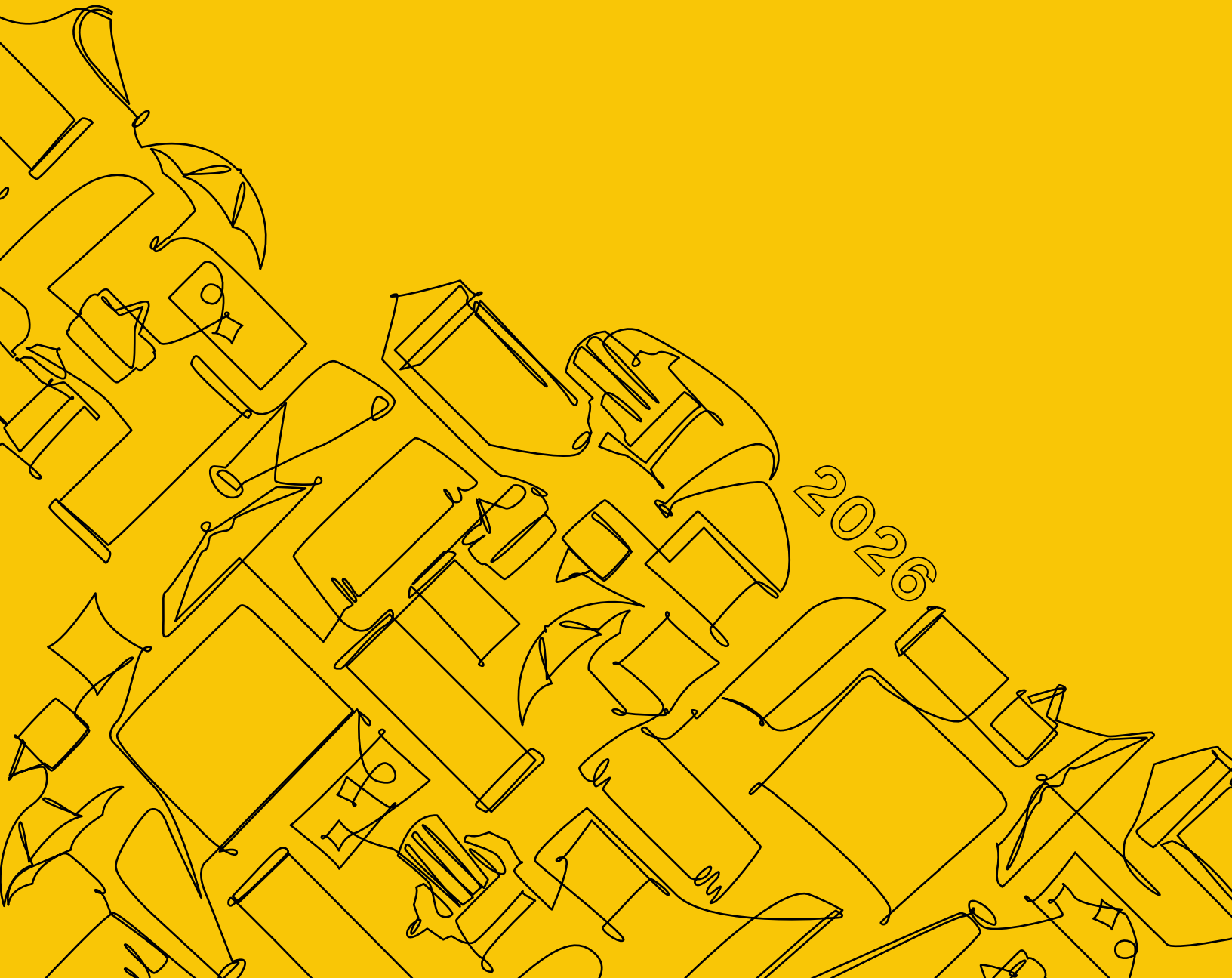

2026

# PRINT ON DEMAND

## SIMPLIFY YOUR WORKFLOW

As a long-time promotional products partner, our print-on-demand capabilities aren't new — they've always been part of what makes us different.

We help distributors offer branded products with speed, precision and no inventory commitment. From one-offs to ongoing programs, we make it simple to deliver high-quality, custom-printed promotional products and displays on demand.

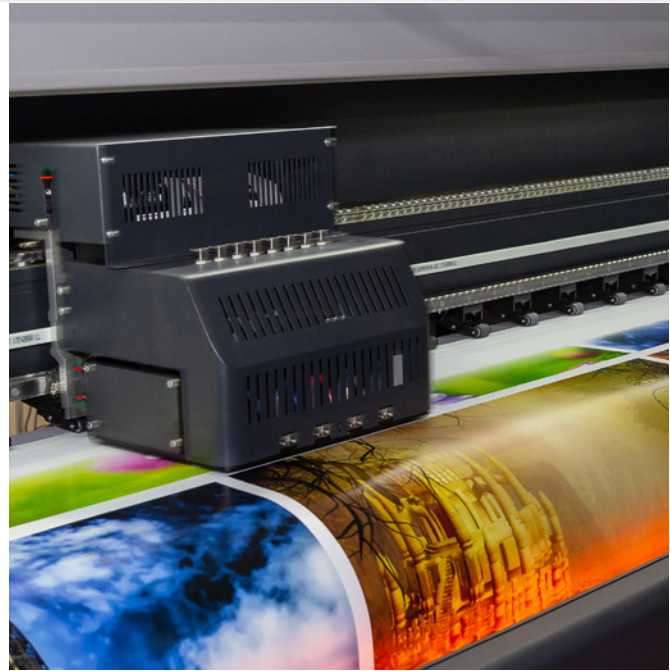

## PRINT & IMPRINT METHODS

See page 288 for print and graphic guidelines.



### Decal

This print method is effective for hard-surface promotional displays. Decals can cover small portions of your product or be fully wrapped. They are applied with a durable adhesive.



### Direct-to-Fabric

This high-quality print method allows artwork to be printed directly onto the media or surface of the promotional displays and products.



### Dye Sublimation

This favored print process uses heat and pressure to dye your artwork into various fabrics. This method allows for full-bleed designs. Ideal for fabric-based promotional displays.



### Embroidery

A classic artwork technique that uses colored threads stitched directly into fabric to create a textured, long-lasting design.



### Engraving

This unique method uses precision tools to carve artwork directly into the surface of the wood. It creates a design with natural depth and texture while highlighting the grain pattern of the material.



### Glass Etching

This print method creates a frosted/matte design on the surface of the glass. The artwork is etched directly into the glass and produces a subtle, elegant effect that cannot be peeled or washed away.



### Laser Etching

This distinct print method uses a focused laser beam to engrave artwork directly onto the surface of a product.



### UV-Printing

This print method uses ultraviolet light to cure ink onto a product. The artwork is durable, fade-resistant and gives off a vibrant appearance. Great for outdoor products.



Scan here for details.

# RUSH **YOUR** ORDER



**RUSH SERVICE** is available for most products at catalog quantities unless otherwise stated on product page. Requires approval by customer care. Same-day service not available. See page 290 for details.

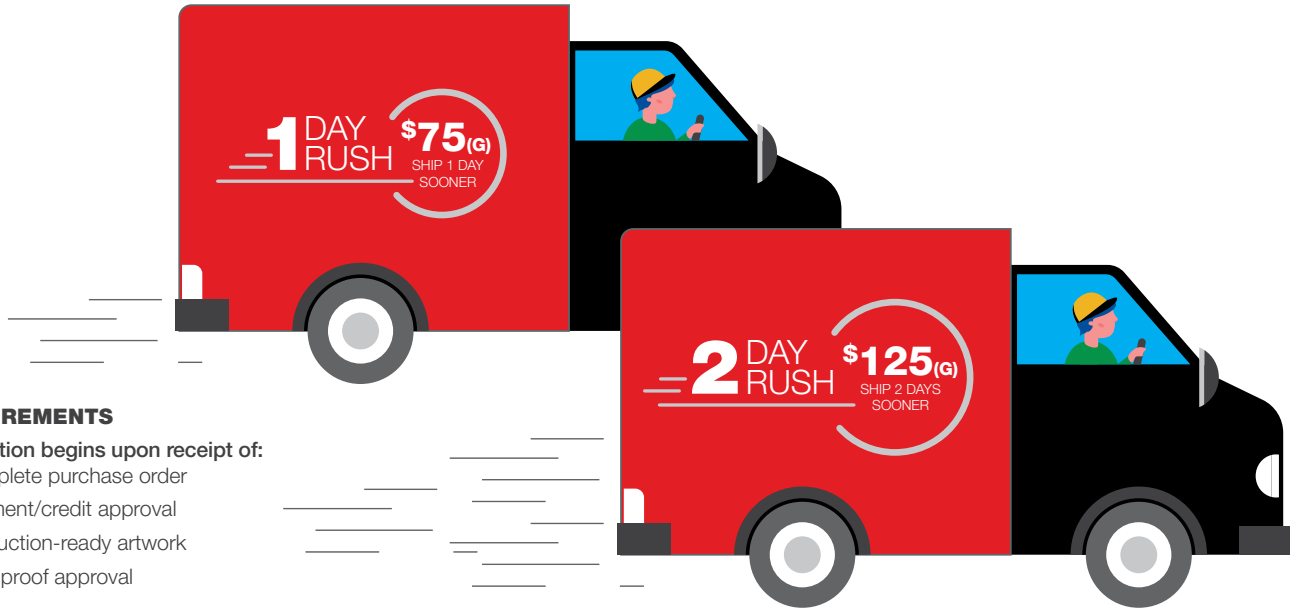

## REQUIREMENTS

Production begins upon receipt of:

- Complete purchase order
- Payment/credit approval
- Production-ready artwork
- Final proof approval

## PRODUCTION LEAD TIMES

Production lead times listed for each product are subject to capacity and inventory levels. Your order will be scheduled within our production lead times or with rush service as requested to meet a required in-hands date. The factory reserves the right to adjust lead times. Customers will be contacted regarding affected orders.



**QUICK SHIPS** are available for select products and ship in just 24 or 48 hours.

Products are available online. Order must be placed via our website. See website for complete Quick Ship program requirements and ordering information.

## KITTING & FULFILLMENT SERVICES



**WE COVER EVERYTHING!** Showdown Displays is proud to offer our Kitting and Fulfillment Services program. If you require kitting or other fulfillment needs for your order, we have you covered! Simply contact your Sales Rep or our Customer Care team for more information.

Customer Care can be reached by email at [info@showdowndisplays.com](mailto:info@showdowndisplays.com) or by phone at 888-376-7469.

# FIND PRODUCT INFO QUICK & EASY

**EUROFIT BANNER DISPLAY**

A fabric graphic cover slides over a tubed frame, letting you create amazing backdrops or portable privacy walls.

- Multiple sizes can be arranged together for endless display possibilities
- Artwork is dye sublimated on recycled polyester knit
- Double-sided graphic cover is viewable from both the front and back of the display
- Steel base with a black, powder-coated finish
- Not compatible with EuroFit Connector or EuroFit Cascade Merchandiser kits

Item #	Description	1	2.5	4-11	12-24
255110	2' Kit	285.75	277.25	268.75	260.00
255113	3' Kit	383.00	381.00	369.25	357.50
255116	4' Kit	525.00	513.00	497.25	485.25
255119	5' Kit	591.00	577.50	559.50	546.00

Setup fee: \$25 (EQ)  
Kit includes: Hardware, Graphic Cover and Soft Carry Case USD MSRP (2)

Description	Product Size	Finished Graphic Size	Product Wt.
2'	25.75" x 37.75" x 10" D	view online template	15.5 lb.
3'	37.75" x 51.75" x 10" D	view online template	20.5 lb.
4'	51.75" x 65.75" x 10" D	view online template	25.5 lb.
5'	65.75" x 79.75" x 10" D	view online template	31.5 lb.

Recycled Polyester Knit: This 100% recycled media is made with fibers recycled from plastic bottles. Recycled bottles are collected worldwide, cleaned and baled, and made into resin that can be made into fibers.

Graphic cover slides easily over the frame for quick setup.

Plastic feet elevate the display and keep it upright.

**4 DAYS** production lead time (other than global operations)

**1. ICONS**  
These icons identify features and services associated with each product (see page 7).

**2. PRODUCT DETAILS**  
Additional product information alongside detailed images.

**3. PRODUCT SETUP FEES**  
Part of pricing table that shows the product set up fee charge.

**4. PRICING IS SUBJECT TO CHANGE**  
Part of pricing table that states that the pricing is subject to change.

**5. PRODUCT SPECIFICATIONS**  
Dimensions, weights, sizes and materials.

**6. PRODUCTION LEAD TIME**  
The number of days an imprinted product will take to produce *after* receiving final proof approval (see page 290 for details).

## VISIT OUR WEBSITE FOR DETAILED PRODUCT INFORMATION

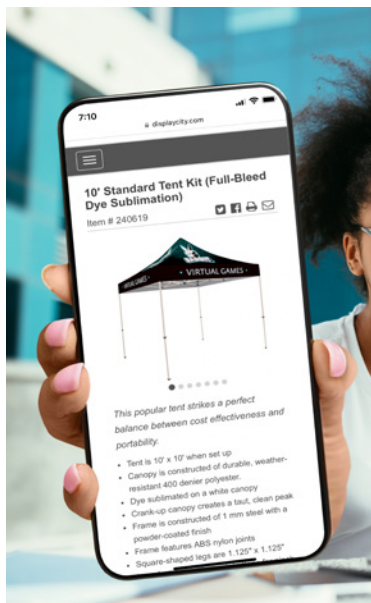

**ARTWORK TEMPLATES**  
Download PDF templates and set up your artwork using industry-preferred design software.

**PRODUCT IMAGES**  
Detailed and high-resolution images of product features.

**PRODUCT INSTRUCTIONS**  
Detailed PDF instructions are available to view, print or download.

**ASSEMBLY VIDEOS**  
Step-by-step assembly instruction videos ensure quick and easy setup.

# TABLE OF CONTENTS

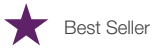

Best Seller



Sustainable Product



Ideal for Outdoor Use

**NEW**

New, New & Improved  
or New Styles Added to the Product Line

## TABLE COVERS (8-25)

★ Convertible Table Throw	14
Deluxe Table Throw	17
★ Economy Table Throw	10-11
◆ Enviro Pro Table Throw	17
Fitted Round Table Throw	22
★ Fitted Table Throw	21
LazerLine Table Runner	24
★ LazerLine Table Throw	15
Lightweight Table Throw	21
● Outdoor Fitted Table Throw	22
Premium Table Throw	16
Round Table Throw	23
Stain-Resistant Pro Table Throw <b>NEW</b>	20
★ Standard Table Runner	25
★ Standard Table Throw	12-13
<b>Table Cover Comparison Chart</b>	9
UltraFit Crossover	19
★ UltraFit Table Throw	18-19
Value Lite Table Throw	20

## RETRACTABLE BANNERS (26-43)

★ Deluxe Pro Retractor	33
◆ Dual Retractor	31
★ ◆ Economy Plus Retractor	32
★ ◆ Economy Retractor	28-29
● Element Retractor	40
★ Ideal Retractor	31
InstaChange Retractor	39
Jumbo Wide Retractor	42
LiteWay Economy Retractor <b>NEW</b>	36
LiteWay Stratus Retractor <b>NEW</b>	37
MagnaLink Retractor	39
★ ◆ Mini Retractors	43
● Outdoor Trek Lite Retractor	40
● Plaza Retractor	41
<b>Retractable Banner Comparison Chart</b>	27
Spotlight Retractor	38
★ ◆ Stratus Retractor	34-35
Superb Retractor	38
★ Value Retractor	30

## BANNER DISPLAYS (44-55)

Essential Banner Display	51
★ Euro-X Banner Display	48
◆ EuroFit Angle Banner Display	53
★ ◆ EuroFit Banner Display	45
◆ EuroFit Hanging Banner	54
◆ EuroFit Pro Hanging Banner	54
◆ EuroFit Round Banner Display	52
Everyday Banner Displays	49
◆ Everyday Impress Display	50
◆ Flex Banner Display	50
★ FrameWorx Banner Display	46
★ FrameWorx Face Cutout Banner Display	47

## BANNER DISPLAYS (44-55) CON'T

★ ● Headliner Banner Display	55
● Headliner Face Cutout Banner Display	55
● ◆ Outdoor Ballast Display	55
Taurus Banner Display	48
★ Tri-X Banner Display	48

## BANNERS & FLAGS (56-91)

<b>Banner Material Comparison Chart</b>	57
★ ● Banners - 9 oz. Mesh Vinyl	58
● ◆ Banners - 9 oz. PVC-Free	58
● Banners - 10 oz. Scrim Vinyl	59
★ ● Banners - 13 oz. Scrim Vinyl	59
Banners - 13 oz. Smooth Scrim Vinyl	60
★ ● Banners - 18 oz. Opaque Scrim Vinyl	61
Banners - Hanging <b>NEW</b>	63
● Banners - Nylon	62
● ◆ Banners - Parade	68
Banners - Poly Poplin	64
Banners - Satin	65
● Banners - Super Poly Knit Fabric	65
● ◆ Banners - Tearaway	68
● Boulevard Banners - Brackets	67
● Boulevard Banners - Fabric	66
● Boulevard Banners - Vinyl	66
<b>Flag Comparison Chart</b>	69
● Flags - Canada Province	73
● Flags - Car	76
● Flags - Fabric Burgee	75
● Flags - Fabric Guidon	75
● Flags - Fabric Pennant	74
★ ● Flags - Fabric Rectangle <b>NEW</b>	74
● Flags - Golf	76
● Flags - Nylon Burgee	71
● Flags - Nylon Guidon	71
● Flags - Nylon Pennant	70
★ ● Flags - Nylon Rectangle	70
● Flags - Pennant String	76
● Flags - Spirit	77
● Flags - State	73
● Flags - Stick <b>NEW</b>	77
● Flags - United States <b>NEW</b>	72
● Flutter Flags - Solid-Color	89
● Flutter Flags - Stadium	89
<b>Sail Sign Comparison Chart</b>	78-79
★ ● Sail Sign - Accessories	90-91
● Sail Sign - Ascent	88
● Sail Sign - Elite	86-87
● Sail Sign - Mini	88
★ ● Sail Sign - Premium	84-85
★ ● Sail Sign - Streamline	82-83
★ ● Sail Sign - Value <b>NEW</b>	80-81

## SIGNAGE (92-113)

◆ Adjustable Sign Display	106
◆ Aerial SEG	110
Aerial SEG Glo	110
● ◆ Coro A-Frame	100
★ ● ◆ Corrugated Plastic Sign	100
● Deluxe Wood A-Frame	95
● Economy Wood A-Frame	95
● ◆ EuroFit Flex Sign	103
Flat Base Sign Display	107
Floor Decor	112
★ ◆ Floor Hugger Mat	113
● FrameWorx Flex	103
◆ Galleria A-Frame	97
● Horizontal A-Frame	99
◆ Impress Lite A-Frame	98
Indoor Surface Grip	112
Luxe Glo Edge	107
Luxe Glo Message Board	107
Luxe Glo Sign	107
● Magnet Promo Sign	111
● Menu Board A-Frame	95
● Opaque Window Cling	111
● Outdoor Flex Signs	102
● Parking Pal	101
● Rover Portable Sign Post	102
<b>Signage Comparison Chart</b>	93
★ ● Signcade A-Frame	94
★ ● Signcade Deluxe A-Frame	94
● Simpo Sign II A-Frame	94
★ ● Standard Step Stake	100
Standard Wall-Mount SEG Glo	109
● Storm Mat	113
● Sunrise Lawn Sign	104
● Sunrise Multisurface Sign	104
● Superstrong Angle Iron A-Frame	98
● Swing A-Frame	96
◆ Tower Tiles	105
◆ Tower Trio	105
● Twist-Up Oval A-Frame	99
Uptown A-Frame	96
Uptown Accent A-Frame	97
◆ Value Wall-Mount SEG	108
● Wayfinding Sign	101
Wayfinding Sign Post	106

## TENTS (114-129)

● 5' Economy	117
● 5' Economy Plus	117
★ ● 6' & 8' Deluxe	119
★ ● 10' Deluxe	120
● 10' Economy	117
● 10' Economy Plus	117
● 10' Elite	126
● 10' Omni	122
★ ● 10' Premium	123
● 10', 15' & 20' Premium Gable	125



Best Seller



Ideal for Outdoor Use



Sustainable Product



New, New & Improved, or New Styles Added to the Product Line

**TENTS (114-129) CON'T**

- ★ 10' Standard 118
- 10' Tent with Vented Canopy 121
- 10' Tent and Wall Kits 127
- ★ 15' & 20' Premium 124
- Accessories **NEW** 127
- Tent Comparison Chart** 115
- Walls 128-129

**MARKET UMBRELLAS (130-141)**

- 7' Deluxe 134
- 7' E-Z Glide 136
- 7' Market 133
- ★ • 7' Steel 132
- ★ • 7' Wood 137
- 7' Wood Look Tilting 138
- 8' Square 139
- 9' Deluxe 135
- 9' Wood Look Tilting 139
- Market Umbrella Bases 141
- Market Umbrella Comparison Chart** 131
- St. Tropez 141
- Venetian 140

**HANDHELD UMBRELLAS (142-163)**

- Auto Challenger 149
- CEO 160
- Challenger II 147
- Challenger with Alternating Panels 148
- Challenger with Checkerboard Panels 148
- Champ II 151
- Classic Fashion 155
- Duke 161
- E-Z Fold 146
- E-Z Fold Vented 146
- Euro Fashion 155
- Folding Challenger III 150
- Freedom 158
- Gale Force Golf 162
- Golf 147
- **Handheld Umbrella Comparison Chart** 143-144
- Hurricane 156
- JingleBrella™ 157
- Judge 160
- Luxe 154
- Madison 161
- ★ • Mini Umbrellas 163
- Park Avenue 1 152
- Park Avenue 2 152
- Park Avenue 3 153
- Park Avenue 4 153
- Park Avenue 5 154
- ★ • Rebel 2 159
- Rebel 3 159
- Redwood 158
- Sport & Street 151
- Sport Challenger 149
- Spotlight 157
- Square Challenger 150
- ★ • Steal 145
- Storm 2 163

**HANDHELD UMBRELLAS (142-163) CON'T**

- Super Windy 162
- Zion 156

**LIFESTYLE & EVENTS (164-185)**

- ★ • Bag Toss Game 165
- Bag Toss Game Accessories 165
- Barricade Cover 185
- BBQ Grill Apron 181
- Compact Folding Wagon 183
- Cornhole - Cooler 167
- Cornhole - Nighttime 167
- Cornhole - Portable 166
- ★ • Cornhole - Wood 166
- EuroFit Barricade 185
- Flying Saucer Game 171
- Fridge - 4L Mini 176
- Fridge - 10L Mini 177
- Fridge - 20L Mini 177
- Fridge - 50L Countertop 178
- Fridge - 80L Large Countertop 178
- Giant Tumble Tower 173
- Giant-4-In-A-Row 173
- Grill - Giant Tailgate 180
- Grill - High Dome 179
- Grill - Kettle 179
- Ka' Plink 175
- Lawn Pong 172
- Nightlife Speaker 183
- Patio Heater 181
- Pickleball - Deluxe Set 168
- Pickleball - Indoor/Outdoor Balls 169
- Pickleball - Set 168
- ★ • Pickleball - Set with Net 169
- Portable Fire Pit 182
- Portable Table Tennis 170
- Putting Green Trainer 175
- RedZone Football Toss 172
- Selfie Frame 184
- Smash Paddle Set 170
- Spin 'N Win Mini Prize Wheel 174
- ★ • Spin 'N Win Prize Wheel 174
- Stainless Steel Fire Pit 182
- Tabletop Tumble Tower 176
- Trashworks Wrap 184
- Tuscany Pizza Oven 180
- Washer Toss Game 171

**COOLERS (186-201)**

- 15L Grab-N-Go Cooler 192
- 15L Mini Cool Bar 200
- 25L OBP Rotomolded Cooler 192
- 35L OBP Wheeled Explorer Cooler 193
- 45L Bench Cooler 193
- 45L Cool Bar 200
- 54QT Fully Wrapped Rotomolded Cooler 196
- 65L Rolling Cooler 191
- Big Chill Cooler 197
- IGLOO® 25QT Retro Picnic Basket Cooler 188
- IGLOO® 28QT Rolling Cooler 189
- IGLOO® 50QT Marine Profile Cooler 191
- ★ • IGLOO® 60QT Rolling Cooler 189

**COOLERS (186-201) CON'T**

- IGLOO® Backpack Cooler **NEW** 197
- IGLOO® KoolTunes Cooler 188
- IGLOO® Party Bar Cooler 190
- IGLOO® Playmate Elite Cooler 187
- IGLOO® Tag Along Too Cooler 187
- Metal Party Cooler 198
- Metal Tool Box Cooler 198
- Outdoor Event Cooler 190
- Personal Cooler Bag 196
- Raise the Bar Cooler 201
- Rolling Cooler Vending Cart 201
- Sasquatch™ 25L Cooler 194
- ★ • Sasquatch™ 54QT Cooler 195
- Sasquatch™ 54QT Bluetooth Music Cooler 195
- Sasquatch™ 54QT Wood Top Cooler 194
- Vintage Cooler 199
- Wood Top Cooler 199

**BAGS (202-213)**

- Back-to-Basics Backpack 212
- Baron Tote 208
- Carry-All Tote 205
- Classic Boat Bag 204
- Classic Duffel 210
- Executive Duffel 211
- Flex Tote **NEW** 209
- Hampton Tote 208
- Jamie Tote 206
- Leader of the Pack Backpack 213
- MVP Duffel 210
- On-the-Go Backpack 212
- On-the-Go Belt Bag 211
- On-the-Go Tote 205
- Open Canvas Boat Bag 204
- Pickleball Carry Bag 213
- Rivet Tote 207
- ★ • Rock the Boat™ Bag 203
- Rope Tote 207
- Striped Canvas Tote 206
- ★ • Traveler Bag 209

**MODULAR DISPLAYS (214-229)**

- Astra - Accessories 222
- Astra - Booth Kits 223
- Astra - Connector Sets 221
- Astra - Counter 222
- Astra - Tabletop **NEW** 221
- Astra - Wall 221
- Journey - Booth Kits 219
- Journey - Connector Sets 217
- Journey - Counter 218
- Journey - Enclosure 218
- Journey - Header 218
- ★ • Journey - Wall 217
- Modular Display Comparison Chart** 215
- Triga® Go - Accessories **NEW** 228
- Triga® Go - Booth Kits 229
- Triga® Go - Counter 226
- Triga® Go - Tower **NEW** 227
- Triga® Go - U-Booth 226
- Triga® Go - Wall 225

**FLOOR DISPLAYS (230-247)**

ARISE Pop-Up Display	241
★ ◆ Bravo Expanding Display	239
Case-to-Counter Conversion Kit	241
Deluxe GeoMetrix Back Wall	243
★ Deluxe GeoMetrix Display	244-245
◆ EuroFit - Evolution	236
◆ EuroFit - Infinity	236
EuroFit - Light Clamp	235
◆ EuroFit - LiteWay <b>NEW</b>	234
◆ EuroFit - Plus	234
★ ◆ EuroFit - Straight Wall	232-233
EuroFit - Wall Accessories	235
EuroFit - Wheeled Feet	235
GeoMetrix & Deluxe Graphic Panels	243
GeoMetrix Display	242
<b>Pop-Up Comparison Chart</b>	240
SEG - Corner Connector Set	237
SEG - Deluxe Glo	237
SEG - Fusion Glo	239
SEG - Premier Glo	238
SEG - Standard Glo	237
★ ◆ Splash Display	246-247

**TABLETOP DISPLAYS (248-257)**

Dynamo Trifecta Display	255
◆ EuroFit Tabletop Straight Wall	252
◆ EuroFit Trifecta <b>NEW</b>	253
Fast Trak Display	254
★ Micro GeoMetrix Display <b>NEW</b>	250
Micro GeoMetrix Graphic Panels	251
★ ◆ Mini Displays	257
★ ◆ Mini Retractors <b>NEW</b>	256
◆ Over-The-Top Display	253
◆ Splash Tabletop Display	249

**STANDS & FURNITURE (258-279)**

◆ Ad Director's Chair	272
◆ Adirondack Chair	269
◆ Bahama Beach Chair	274
◆ Bistro Table	267
◆ Collapsible Counter	262
Collapsible Lit Counter	262
★ ◆ CounterPop	259
◆ Director's Chair	272
◆ Double Party Chair	278
Easels	279
◆ Elm Street Bar Cart	267
Exhibition Counter <b>NEW</b>	261
Impress Counters	260
◆ Jones Beach Chair Combo	274
Literature Displays	279
◆ Metal Sling Chair <b>NEW</b>	273
◆ Party Chair	278
◆ Party Table	266
◆ Polyresin Adirondack Chair	269
◆ Pop-Up Table	265
◆ Portable Bar	268
◆ Portable Wood Bar	268
Promo Counters <b>NEW</b>	261
★ ◆ Retro Webbing Chair	271

**STANDS & FURNITURE (258-279) CON'T**

◆ ◆ Rio Grande Beach Chair	275
◆ ◆ Rocker Chair	271
ShowGlower Counter	264
ShowGlower Podium	263
ShowGlower Totem	264
ShowGlower Totem Table	264
ShowGoer Case-to-Podium	263
◆ Sling Chair	273
◆ ◆ South Beach Lounger Chair	275
◆ ◆ Sports Chair	277
◆ Stadium Table	266
◆ ◆ Tailgating Couch	277
Transport Case-to-Counter	260
◆ ◆ Wood Dock Chair	276
◆ ◆ Zen Master Travel Chair	276
◆ ◆ Zero Gravity Chair	270

**DECOR (280-285)**

Acrylic Prints	282
★ Aluminum Prints	283
★ Blankets	281
◆ Door Wrap	285
◆ Garden Flag	285
★ Indoor Pillows	282
Tapestries	284
Wall Decal	284

**ACCESSORIES (286-287)**

Hard Cases	286
LED Tent Light <b>NEW</b>	287
Prime LED Light Kit	287
Soft Cases	287
★ Ultimate LED Light Kits	287

**USER-FRIENDLY ICONS**

These icons identify features and services associated with each product.



**Best Seller**  
This is one of our best-selling products.



**Outdoor Use**  
This product is suitable for outdoor use during mild weather conditions.



**Case**  
This product includes a hard case or soft carry case. See "Kit Includes" in the pricing table for details.



**USA Plug Compatible**  
Product requires a plug and is compatible with any USA standard outlet.



**Canopy Warranty**  
This is the duration of the canopy warranty (see page 290 for details).



**Product Warranty**  
This is the duration of the product warranty (see page 290 for details).



**Custom Shape**  
This product can be cut into custom shapes.



**Quick Ship**  
We can ship this item in 24 or 48 hours (see website for details).



**Graphics Online**  
Graphic-only options available on our website.



**RCAT Rating**  
A rating that relates to the durability of a retractable banner (see page 27 for details).



**Hardware Online**  
Hardware-only options available on our website.



**Sustainable Product**  
One or more materials with a reduced environmental impact. Check your local recycling guidelines.



**Hardware Warranty**  
This is the duration of the hardware warranty (see page 290 for details).



**Tool(s) Required**  
This product requires tool(s) for setup; tool(s) included.



**Lights Up**  
This product lights up.



**Video Setup**  
Video setup instructions for this product can be found on our website.



**Machine-Washable**  
This product's graphic is machine-washable on gentle cycle using mild detergent.



**Wind Rating**  
This product has been rated on the Beaufort Wind Rating (see page 291). Wind ratings were determined utilizing all available securing/stabilizing options sold with or offered for the product.



**Made in the USA**  
This product is manufactured in the USA.



# TABLE COVERS

1. Café-Height Round Throw page 23 2. Outdoor Fitted Throw page 22 3. Economy Throw pages 10-11

## have you considered...

- **size** what is the size of your table?
- **fabric/media** what type of material are you looking for?
- **frequency** how often will you be using your table cover?
- **use** will people be sitting at the table, or will it be used to showcase merchandise or promotional materials?
- **message** do you want a logo printed on the front or would you like a design that covers the entire throw?

## how to **DISPLAY**

Table covers can bring a sense of professionalism and branding consistency to your events. Display at various types of events, such as trade shows, seminars, product launches, job fairs, craft fairs, fundraisers, and pop-up shops.

# TABLE COVER COMPARISON CHART

BEST SELLERS ★ SUSTAINABLE ◆			TABLE SIZES					TABLE FIT	TABLE COVERAGE		MATERIAL	FINISHED EDGE	FR	PRINT OPTIONS		
	RECTANGLE	PG #	4'	6'	8'	12'	16'		3-SIDED	4-SIDED				FULL-COLOR IMPRINT	FULL-COLOR FRONT ONLY	FULL-COLOR FULL-BLEED
Convertible ★	14			X				Drape / Fitted		X	Polyester Poplin	Serged	✓		X	X
Deluxe	17	X	X	X				Drape	X	X	Heavyweight Polyester Knit	Hemmed	✓			X
Economy ★	10	X	X	X	X	X		Drape	X		Polyester Poplin	Serged	✓		X	X
Enviro Pro ◆	17		X	X				Drape	X	X	Recycled Polyester Knit	Serged	✓			X
Fitted ★	21	X	X	X				Fitted		X	Polyester Poplin	Serged	✓		X	X
LazerLine ★	15		X	X				Drape	X	X	Polyester Poplin	Laser Cut	✓		X	X
Lightweight	21		X	X				Drape	X	X	Lightweight Polyester Knit	Laser Cut	✓			X
Outdoor Fitted	22		X	X				Fitted		X	600 Denier Polyester	Serged	✓			X
Premium	16		X	X				Drape		X	Two-Way Stretch Fabric	Hemmed	✓			X
NEW Stain-Resistant Pro	20		X	X				Drape	X	X	Polyester Poplin	Serged	✓	X		
Standard ★	12	X	X	X	X	X		Drape		X	Polyester Poplin	Serged	✓		X	X
UltraFit Classic ★	18	X	X	X				Snug Fitted		X	Two-Way Stretch Fabric	Hemmed	✓			X
UltraFit Curve ★	18	X	X	X				Snug Fitted	X		Two-Way Stretch Fabric	Hemmed	✓			X
UltraFit Demo	19	X						Snug Fitted		X	Two-Way Stretch Fabric	Hemmed	✓			X
Value Lite	20		X	X				Drape		X	Polyester Pongee	Serged	✓	X <small>(white imprint only)</small>		
ROUND		PG #	31.5" BAR	31.5" CAFE	3'	4'	5'		3-SIDED	4-SIDED				FULL-COLOR IMPRINT	FULL-COLOR FRONT ONLY	FULL-COLOR FULL-BLEED
Fitted Round	22	X						Fitted		X	Polyester Poplin	Serged	✓		X	X
Round	23	X	X	X	X	X		Drape		X	Polyester Poplin	Serged	✓			X
UltraFit Round ★	19	X						Snug Fitted		X	Two-Way Stretch Fabric	Hemmed	✓			X
PARTIAL COVERAGE		PG #	12"	28"	36"	57"	6'							FULL-COLOR IMPRINT	FULL-COLOR FRONT ONLY	FULL-COLOR FULL-BLEED
LazerLine Runner	24	X	X	X	X			Drape	Partial Front, Top & Back		Polyester Poplin	Laser Cut	✓		X	X
Standard Runner ★	25		X		X			Drape	Partial Front, Top & Back		Polyester Poplin	Serged	✓		X	X
UltraFit Crossover	19					X		Snug Fitted	Partial 4-Sided		Two-Way Stretch Fabric	Hemmed	✓			X

NOTE: Flame retardant certified in compliance with the National Fire Protection Association Standard No. 701.

## 28 Stock Throw Colors

WHITE ★	RED PMS 201	AQUAMARINE PMS 2231	SHAMROCK PMS 361
LEMON ★	BURGUNDY PMS 504	COBALT ★	HUNTER GREEN PMS 350
YELLOW PMS 1235	FLAMINGO PMS 1767	BLUEBERRY PMS 647	HAZELNUT PMS 7575
MANGO PMS 1375	HOT PINK PMS 219	ROYAL BLUE PMS 661	BROWN PMS 476
ORANGE PMS 1505	MULBERRY PMS 683	NAVY BLUE ★	GRAY PMS 422
PEACH PMS 162	GRAPE PMS 268	LIME GREEN PMS 375	CHARCOAL PMS 425
CHERRY ★	PURPLE PMS VIOLET	EMERALD ★	BLACK ★

PMS colors are for reference only and may vary slightly from actual color.  
\* indicates stock throw colors that closely align with our stock tent canopy colors. See page 116.

## Print Options

### Full-Color Imprint

- Simple to complex graphics (see product pages for details)
- Vector art required; imprinted on front only
- Available in limited stock fabric colors only
- Min. and max. artwork size requirements apply
- Always roll your table throw for storage; do not fold

### Full-Color Front Only

- Simple to complex graphics
- Vector and raster art accepted; imprinted on front only
- Available in stock fabric colors only
- Maximum artwork size requirements apply
- Large maximum imprint area for more graphic coverage
- Fold and store in included poly bag

### Full-Color Full-Bleed

- Simple, complex and photographic graphics
- Vector and raster art accepted
- Artwork is dye sublimated on white fabric only
- Full-color artwork can be printed across the entire throw
- No artwork size requirements
- Fold and store in included poly bag



## Top Seller



Lightweight and durable; our most popular fabric choice.



Nearly opaque with a luxurious look and a high-class hemmed finish.



Lightweight and designed for limited use.



The same durable, weather-resistant material we use for our tent canopies.



100% recycled media is made with fibers recycled from plastic bottles.

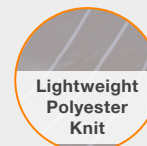

Our lightest weight table throw with high-quality printing.

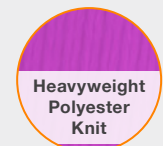

Made from heavyweight, wrinkle-resistant media.

## Throw Media

## ECONOMY TABLE THROW



The open-back design of this throw gives you legroom and quick access to anything you store beneath the table.

- Available in full-color front only and full-color full-bleed
- Full-color front only features a large imprint area
- Draped corners
- Polyester poplin
- Machine-washable and wrinkle-resistant
- Flame retardant certified for exhibit hall use



Front view

6' full-color full-bleed

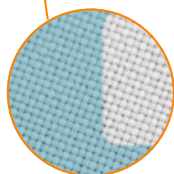

Wrinkle-resistant, durable polyester poplin.

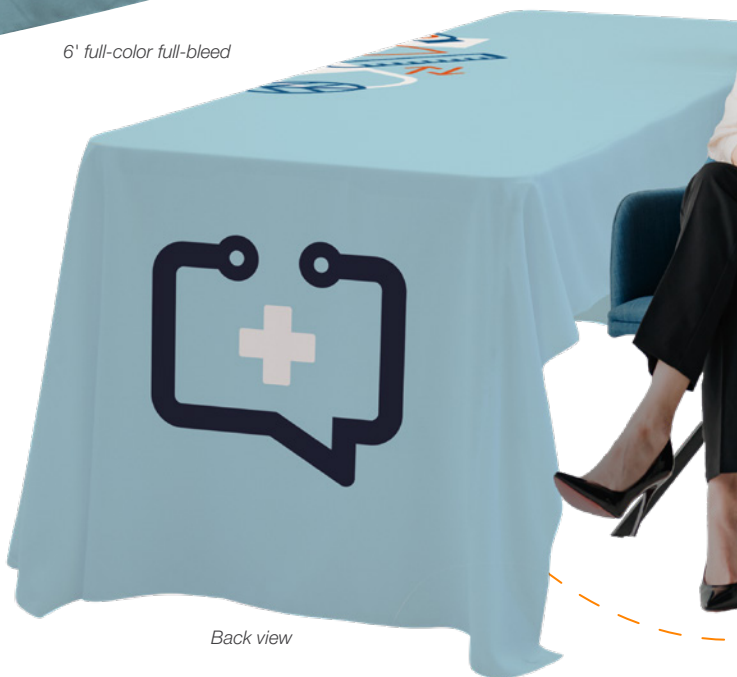

Back view



Covers three sides of the table with a 9" overhang in back.

## TABLE CLAMPS

Securely fasten your table cover to the table with these convenient clamps.

- Set of four
- Constructed of stainless steel

### Table Clamps

Item #	Description	1	2-5	6-11	12-24
240779	Table Clamp (Set of 4)	5.25	5.09	4.94	4.78

Pricing is subject to change.  
USD MSRP (C)





16' shown with full-color full-bleed

**Full-Color Front Only**

Item #	Description	1	2-5	6-11	12-24
106045	4' Economy Throw	123.90	119.00	112.80	106.60
106002	6' Economy Throw	173.50	166.50	157.90	149.20
106014	8' Economy Throw	192.60	184.90	175.30	165.60
106051	12' Economy Throw	347.00	333.00	315.75	298.25
106053	16' Economy Throw	385.25	369.75	350.50	331.25

**Setup fee: \$20(G)** **Pricing is subject to change.**

Stock fabric colors with full-color artwork printed on front. USD MSRP (C)  
 Artwork cannot exceed maximum size requirements.

Description	Table Size	Finished Graphic Size	Product Wt.
4'	standard 4'W table	view online template	1.25 lbs.
6'	standard 6'W table	view online template	2 lbs.
8'	standard 8'W table	view online template	2.5 lbs.
12'	2 standard 6'W tables	view online template	3.2 lbs.
16'	2 standard 8'W tables	view online template	4.5 lbs.



8' full-color front only shown in gray

6' full-color front only shown in navy blue

**Full-Color Full-Bleed**

Item #	Description	1	2-5	6-11	12-24
106042	4' Economy Throw	123.90	119.00	112.80	106.60
106010	6' Economy Throw	173.50	166.50	157.90	149.20
106022	8' Economy Throw	192.60	184.90	175.30	165.60
106052	12' Economy Throw	347.00	333.00	315.75	298.25
106054	16' Economy Throw	385.25	369.75	350.50	331.25

**Setup fee: \$20(G)** **Pricing is subject to change.**

White fabric fully dye sublimated with full-color artwork. USD MSRP (C)

Description	Table Size	Finished Graphic Size	Product Wt.
4'	standard 4'W table	view online template	1.25 lbs.
6'	standard 6'W table	view online template	2 lbs.
8'	standard 8'W table	view online template	2.5 lbs.
12'	2 standard 6'W tables	view online template	3.2 lbs.
16'	2 standard 8'W tables	view online template	4.5 lbs.

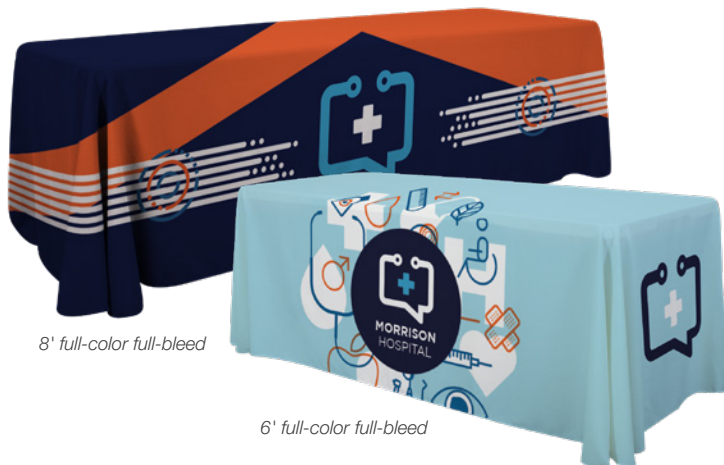

8' full-color full-bleed

6' full-color full-bleed

**HARDWARE-ONLY LEAD TIME: SHIPS SAME DAY WHEN ORDERED BEFORE 2 PM CENTRAL**  
**PRICES ARE SUBJECT TO CHANGE.** No setup fee on orders placed via our website.  
 Visit [showdowndisplays.com](http://showdowndisplays.com) for current pricing, graphic templates, product videos and assembly instructions. See pages 288-291 for order details.  
 SHOWDOWNDISPLAYS.COM · ASI 87188 · PPAI 254687 · SAGE 67383 · PPPC 20101202

production lead time  
 after final proof approval  
**2DAYS**

## STANDARD TABLE THROW



Our most popular table throw is elegant in its simplicity.

- Available in full-color front only and full-color full-bleed
- Full-color front only features a large imprint area
- Covers four sides of the table, viewable from all sides
- Draped corners
- Polyester poplin
- Machine-washable and wrinkle-resistant
- Flame retardant certified for exhibit hall use

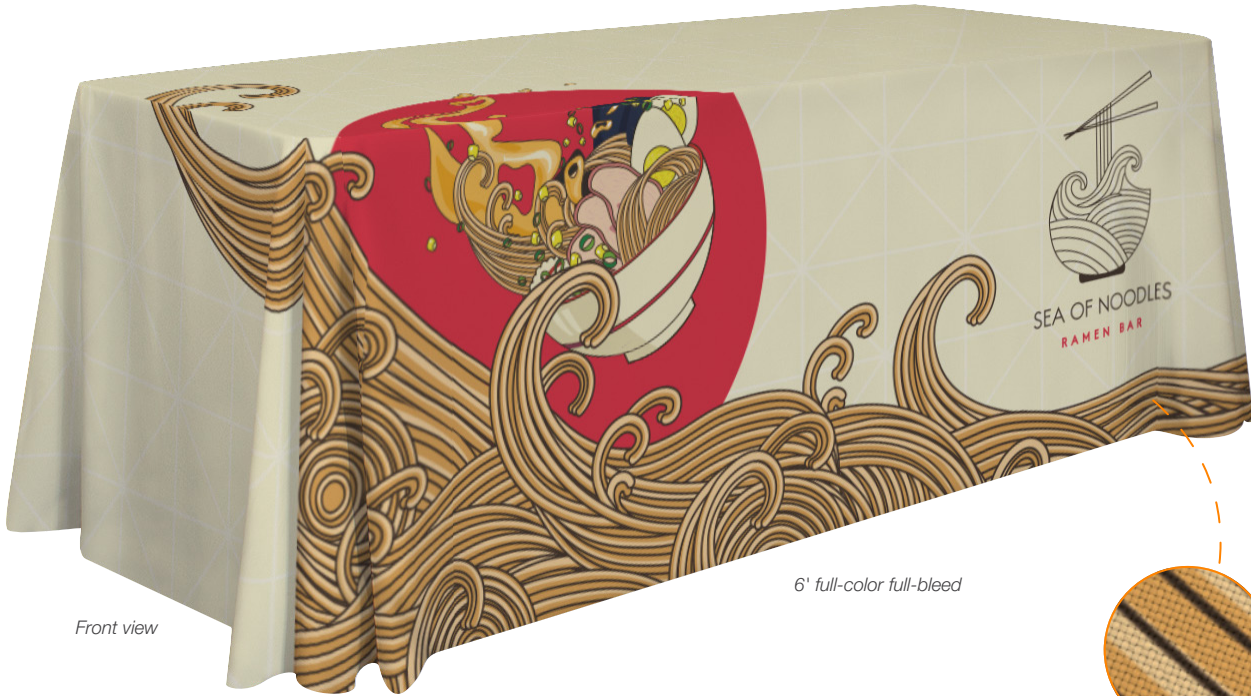

Front view

6' full-color full-bleed

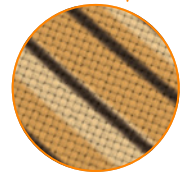

Wrinkle-resistant, durable polyester poplin.



Keep your supplies and accessories out of sight.

Back view



12' shown with full-color front only shown in aquamarine with 6' Fast Trak Tabletop Display (sold separately; see page 254)

**Full-Color Front Only**

Item #	Description	1	2-5	6-11	12-24
109105	4' Standard Throw	133.50	128.10	121.50	114.80
109002	6' Standard Throw	192.60	184.90	175.30	165.60
109014	8' Standard Throw	211.50	203.10	192.50	181.90
109100	12' Standard Throw	385.25	369.75	350.50	331.25
109102	16' Standard Throw	423.50	406.50	385.25	364.25

Setup fee: \$20(G)

Pricing is subject to change.

Stock fabric colors with full-color artwork printed on front. Artwork cannot exceed maximum size requirements.

USD MSRP (C)

Description	Table Size	Finished Graphic Size	Product Wt.
4'	standard 4'W table	view online template	1.5 lbs.
6'	standard 6'W table	view online template	2.5 lbs.
8'	standard 8'W table	view online template	3 lbs.
12'	2 standard 6'W tables	view online template	4 lbs.
16'	2 standard 8'W tables	view online template	5 lbs.



8' full-color front only shown in lime green



6' full-color front only shown in royal blue

**Full-Color Full-Bleed**

Item #	Description	1	2-5	6-11	12-24
109106	4' Standard Throw	133.50	128.10	121.50	114.80
109010	6' Standard Throw	192.60	184.90	175.30	165.60
109022	8' Standard Throw	211.50	203.10	192.50	181.90
109101	12' Standard Throw	385.25	369.75	350.50	331.25
109103	16' Standard Throw	423.50	406.50	385.25	364.25

Setup fee: \$20(G)

Pricing is subject to change.

White fabric fully dye sublimated with full-color artwork.

USD MSRP (C)

Description	Table Size	Finished Graphic Size	Product Wt.
4'	standard 4'W table	view online template	1.5 lbs.
6'	standard 6'W table	view online template	2.5 lbs.
8'	standard 8'W table	view online template	3 lbs.
12'	2 standard 6'W tables	view online template	4 lbs.
16'	2 standard 8'W tables	view online template	5 lbs.



8' full-color full-bleed



6' full-color full-bleed



8' full-color full-bleed  
transforms into a 6' fitted

**Converts from 8' to 6' and Back Again!**



1. Grab the back corner of the table throw.

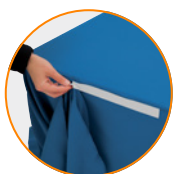

2. Attach the corner to the back of the throw using the built-in hook-and-loop fasteners.



3. Grab the front corner of the throw and fold it tightly around the back corner of the table.



4. Secure it in place with the built-in hook-and-loop fasteners.



**CONVERTIBLE TABLE THROW**



This throw is easily convertible so it fits both 8' and 6' table sizes.

- Available in full-color front only and full-color full-bleed
- Full-color front only features a large imprint area
- Hook-and-loop fasteners make size conversion quick and easy; available in black or white (see website for details)
- Covers four sides of the table
- Polyester poplin
- Machine-washable and wrinkle-resistant
- Flame retardant certified for exhibit hall use



8' full-color front only shown in grape



8' full-color full-bleed

**Full-Color Front Only**

Item #	Description	1	2-5	6-11	12-24
104014	6'/8' Convertible Throw	324.00	281.75	265.75	243.00

Setup fee: \$20(G) Pricing is subject to change.

Stock fabric colors with full-color artwork printed on front. USD MSRP (C)  
Artwork cannot exceed maximum size requirements.

**Full-Color Full-Bleed**

Item #	Description	1	2-5	6-11	12-24
104022	6'/8' Convertible Throw	324.00	281.75	265.75	243.00

Setup fee: \$20(G) Pricing is subject to change.

White fabric fully dye sublimated with full-color artwork. USD MSRP (C)

Table Size	Finished Graphic Size	Product Wt.
standard 6' or 8'W table	view online template	3 lbs.

production lead time after final proof approval

**2DAYS**

**PRICES ARE SUBJECT TO CHANGE.** No setup fee on orders placed via our website.

Visit [showdowndisplays.com](http://showdowndisplays.com) for current pricing, graphic templates, product videos and assembly instructions. See pages 288-291 for order details.

SHOWDOWNDISPLAYS.COM · ASI 87188 · PPAI 254687 · SAGE 67383 · PPPC 20101202



8' full-color full-bleed

6' full-color front only shown in royal blue

### LAZERLINE TABLE THROW



These cost-effective throws are laser-cut for a crisp finished edge.

- Available in full-color front only and full-color full-bleed
- Full-color front only features a large imprint area
- Heat-treated edges will not fray or unravel
- Available in 3-sided or 4-sided throw styles
- Polyester poplin
- Draped corners
- Machine-washable and wrinkle-resistant
- Flame retardant certified for exhibit hall use

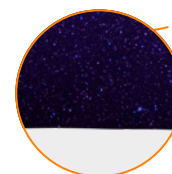

Laser-cut edges for a clean look.

#### Full-Color Front Only

Item #	Description	1	2-5	6-11	12-24
108213	6' LazerLine 3-Sided Throw	129.20	124.10	117.60	111.10
108214	8' LazerLine 3-Sided Throw	143.40	137.70	130.50	123.30
108201	6' LazerLine 4-Sided Throw	143.40	137.70	130.50	123.30
108202	8' LazerLine 4-Sided Throw	157.60	151.30	143.40	135.50

Setup fee: \$20(G)

Pricing is subject to change.

Stock fabric colors with full-color artwork printed on front. Artwork cannot exceed maximum size requirements.

USD MSRP (C)

Description	Table Size	Finished Graphic Size	Product Wt. (3-Sided / 4-Sided)
6'	standard 6"W table	view online template	2 lbs. / 2.5 lbs.
8'	standard 8"W table	view online template	2.5 lbs. / 3 lbs.

#### Full-Color Full-Bleed

Item #	Description	1	2-5	6-11	12-24
108216	6' LazerLine 3-Sided Throw	129.20	124.10	117.60	111.10
108217	8' LazerLine 3-Sided Throw	143.40	137.70	130.50	123.30
108204	6' LazerLine 4-Sided Throw	143.40	137.70	130.50	123.30
108205	8' LazerLine 4-Sided Throw	157.60	151.30	143.40	135.50

Setup fee: \$20(G)

Pricing is subject to change.

White fabric fully dye sublimated with full-color artwork.

USD MSRP (C)

Description	Table Size	Finished Graphic Size	Product Wt. (3-Sided / 4-Sided)
6'	standard 6"W table	view online template	2 lbs. / 2.5 lbs.
8'	standard 8"W table	view online template	2.5 lbs. / 3 lbs.



4-sided table throws offer full coverage on all sides of the table.



3-sided table throws have a 9" overhang in the back to keep the throw from slipping off the table.



Finished with a hemmed edge.



### PREMIUM TABLE THROW



Premium throws are perfect for showcasing eye-catching, full-color imagery with an upscale look.

- Covers four sides of the table
- Artwork is dye sublimated on two-way stretch fabric
- Draped corners
- Nearly opaque material
- Machine-washable
- Flame retardant certified for exhibit hall use

#### Full-Color Full-Bleed

Item #	Description	1	2-5	6-11	12-24
109070	6' Premium Throw	572.00	520.50	497.75	469.25
109071	8' Premium Throw	604.00	549.50	525.50	495.25

Setup fee: \$20(G)

Pricing is subject to change.

White fabric fully dye sublimated with full-color artwork.

USD MSRP (C)

Description	Table Size	Finished Graphic Size	Product Wt.
6'	standard 6'W table	view online template	3.5 lbs.
8'	standard 8'W table	view online template	4.75 lbs.

production lead time after final proof approval

**2DAYS**

**PRICES ARE SUBJECT TO CHANGE.** No setup fee on orders placed via our website. Visit [showdowndisplays.com](http://showdowndisplays.com) for current pricing, graphic templates, product videos and assembly instructions. See pages 288-291 for order details.

SHOWDOWNDISPLAYS.COM · ASI 87188 · PPAI 254687 · SAGE 67383 · PPPC 20101202

## DELUXE TABLE THROW



Made from heavyweight, wrinkle-resistant material and designed to provide a polished look.

- Artwork is dye sublimated on 8 oz. heavyweight polyester knit
- Available in 3-sided or 4-sided throw styles
- Draped corners
- Machine-washable and wrinkle-resistant
- Flame retardant certified for exhibit hall use



8' shown with 3-sides

6' shown with 3-sides

4' shown with 3-sides

### Full-Color Full-Bleed

Item #	Description	1	2-5	6-11	12-24
108260	4' Deluxe 3-Sided Throw	279.75	243.40	229.40	209.80
108261	6' Deluxe 3-Sided Throw	368.75	320.75	302.25	276.50
108262	8' Deluxe 3-Sided Throw	508.50	442.50	417.00	381.50
108263	4' Deluxe 4-Sided Throw	330.25	287.25	270.75	247.70
108264	6' Deluxe 4-Sided Throw	419.50	365.00	344.00	314.50
108265	8' Deluxe 4-Sided Throw	559.50	486.75	458.75	419.75

Setup fee: \$20(G)

Pricing is subject to change.

White fabric fully dye sublimated with full-color artwork.

USD MSRP (C)

Description	Table Size	Finished Graphic Size	Product Wt. (3-Sided / 4-Sided)
4'	standard 4'W table	view online template	2 lbs. / 2.4 lbs.
6'	standard 6'W table	view online template	3 lbs. / 3.6 lbs.
8'	standard 8'W table	view online template	4 lbs. / 4.8 lbs.



Finished with a hemmed edge.

## ENVIRO PRO TABLE THROW



This premium 100% recycled table throw showcases our softest material!

- Artwork is vibrantly dye sublimated on recycled polyester knit
- 100% recycled media is made with fibers recycled from plastic bottles
- Soft to the touch and wrinkle-resistant
- Available in 3-sided or 4-sided throw styles
- Draped corners
- Finished with a clear thread serge along the fabric edge
- Machine-washable
- Flame retardant certified for exhibit hall use

### Full-Color Full-Bleed

Item #	Description	1	2-5	6-11	12-24
108240	6' Enviro Pro 3-Sided Throw	328.25	298.75	285.50	269.25
108242	8' Enviro Pro 3-Sided Throw	368.75	335.50	320.75	302.25
108241	6' Enviro Pro 4-Sided Throw	353.50	321.75	307.50	289.75
108243	8' Enviro Pro 4-Sided Throw	394.00	358.50	342.75	323.00

Setup fee: \$20(G)

Pricing is subject to change.

100% recycled white fabric fully dye sublimated with full-color artwork.

USD MSRP (C)

Description	Table Size	Finished Graphic Size	Product Wt. (3-Sided / 4-Sided)
6'	standard 6'W table	view online template	2.2 lbs. / 2.8 lbs.
8'	standard 8'W table	view online template	2.6 lbs. / 3.2 lbs.



**PRICES ARE SUBJECT TO CHANGE.** No setup fee on orders placed via our website. Visit [showdowndisplays.com](http://showdowndisplays.com) for current pricing, graphic templates, product videos and assembly instructions. See pages 288-291 for order details. SHOWDOWNDISPLAYS.COM · ASI 87188 · PPAI 254687 · SAGE 67383 · PPPC 20101202

production lead time after final proof approval  
**2DAYS**

# ULTRAFIT TABLE THROW



This form-fitting throw is an attractive option for promoting your brand. It stretches to fit tightly around tables, creating a crisp, refined appearance.

- Tight, form-fitting look
- Artwork is dye sublimated on two-way stretch fabric
- Machine-washable and wrinkle-resistant
- Flame retardant certified for exhibit hall use



## UltraFit Curve

Item #	Description	1	2-5	6-11	12-24
114032	4' Full-Color Full-Bleed	270.50	259.50	246.10	232.60
114015	6' Full-Color Full-Bleed	386.25	371.00	351.50	332.25
114018	8' Full-Color Full-Bleed	428.75	411.75	390.25	368.75

Setup fee: \$20(G)

Pricing is subject to change.

White fabric fully dye sublimated with full-color artwork.

USD MSRP (C)

Description	Table Size	Finished Graphic Size	Product Wt.
4'	standard 4'W table	view online template	1.3 lbs.
6'	standard 6'W table	view online template	2.25 lbs.
8'	standard 8'W table	view online template	2.75 lbs.

## UltraFit Classic

Item #	Description	1	2-5	6-11	12-24
114034	4' Full-Color Full-Bleed	305.50	293.25	278.00	262.75
114002	6' Full-Color Full-Bleed	407.75	391.50	371.00	350.75
114005	8' Full-Color Full-Bleed	452.75	434.75	412.00	389.50

Setup fee: \$20(G)

Pricing is subject to change.

White fabric fully dye sublimated with full-color artwork.

USD MSRP (C)

Description	Table Size	Finished Graphic Size	Product Wt.
4'	standard 4'W table	view online template	1.75 lbs.
6'	standard 6'W table	view online template	2.5 lbs.
8'	standard 8'W table	view online template	3 lbs.



Zippered back for enclosed storage area.

**UltraFit Round**

Item #	Description	1	2-5	6-11	12-24
114012	31.5" Bar-Height Full-Color Full-Bleed	353.50	339.25	321.50	304.00

Setup fee: \$20(G)

Pricing is subject to change.

White fabric fully dye sublimated with full-color artwork.

USD MSRP (C)

Table Size	Finished Graphic Size	Product Wt.
31.5"D bar-height table	view online template	1.75 lbs.

**UltraFit Demo**

Item #	Description	1	2-5	6-11	12-24
114100	4' Full-Color Full-Bleed	367.00	352.25	334.00	315.75

Setup fee: \$20(G)

Pricing is subject to change.

White fabric fully dye sublimated with full-color artwork.

USD MSRP (C)

Table Size	Finished Graphic Size	Product Wt.
standard 4'W demo table	view online template	2 lbs.

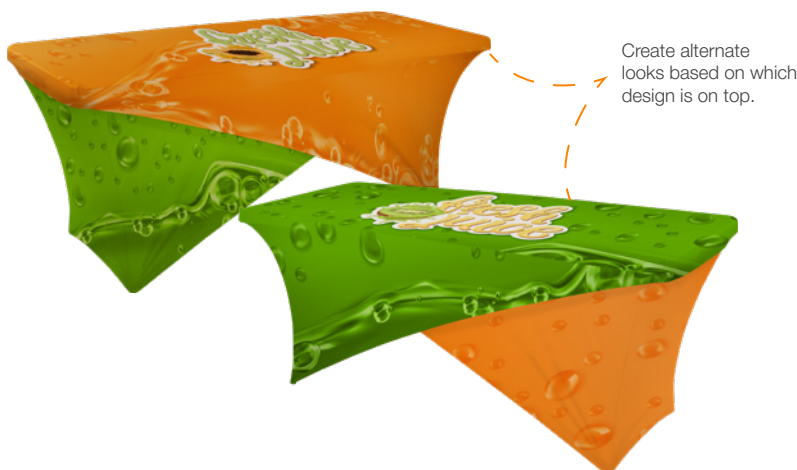

Create alternate looks based on which design is on top.

**UltraFit Crossover**

Item #	Description	1	2-5	6-11	12-24
109090	6' Full-Color Full-Bleed	417.25	400.50	379.75	358.75

Setup fee: \$20(G)

Pricing is subject to change.

White fabric fully dye sublimated with full-color artwork.

USD MSRP (C)

Table Size	Finished Graphic Size	Product Wt.
standard 6'W table	view online template	3 lbs.



**Best Fits**

**31.5" Round Table Throws**  
Fits on tables: 43"H x 31.5"D

**4' Demo Table Throws**  
Fits on tables: 47.75"W x 36"H x 24"D

**4' Classic & Curve Table Throws**  
Fits on tables: 48"W x 29"H x 29.75"D

**6' Classic & Curve Table Throws**  
Fits on tables: 72"W x 29"H x 29.75"D

**8' Classic & Curve Table Throws**  
Fits on tables: 96"W x 29"H x 29.75"D





8' shown in navy

**NEW & IMPROVED**

**STAIN-RESISTANT PRO TABLE THROW**



Don't stress over the occasional spill. This table throw is designed to be stain-resistant by repelling liquids instead of absorbing them.

- Available in 3-sided or 4-sided throw styles
- Draped corners
- Available in seven stock fabric colors
- Made from stain-resistant polyester poplin; compliant with California PFAS regulation on textiles
- Machine-washable and wrinkle-resistant
- Flame retardant certified for exhibit hall use



6' shown in red

**Full-Color Imprint**

Item #	Description	1	2-5	6-11	12-24
114134	6' Stain-Resistant Pro 3-Sided Throw	256.75	223.40	210.50	192.60
114135	8' Stain-Resistant Pro 3-Sided Throw	282.00	245.30	231.20	211.50
114136	6' Stain-Resistant Pro 4-Sided Throw	282.00	245.30	231.20	211.50
114137	8' Stain-Resistant Pro 4-Sided Throw	307.50	267.50	252.25	230.60

**Setup fee: \$20(G)**

**Pricing is subject to change.**

Stock stain-resistant fabric colors imprinted with any color(s).

USD MSRP (C)

Description	Table Size	Finished Graphic Size	Product Wt. (3-Sided / 4-Sided)
6'	standard 6'W table	view online template	2 lbs. / 2.5 lbs.
8'	standard 8'W table	view online template	2.5 lbs. / 3 lbs.



3-sided table throws have a 9" overhang in the back to keep the throw from slipping off the table.



4-sided table throws offer full coverage on all sides of the table.

**Stock Stain-Resistant Pro Throw Colors**

- Black
- Hunter Green PMS 350
- Gray PMS 422
- Red PMS 201
- Navy Blue PMS 2767
- Royal Blue PMS 661
- White

PMS colors are for reference only and may vary slightly from actual color.



8' shown in black



6' shown in red

**VALUE LITE TABLE THROW**



Value Lite table throws provide a cost-effective option for simple white logo designs.

- Covers four sides of the table
- Draped corners
- Available in five stock fabric colors; white imprint only
- Short-term use
- Minimum order quantity of three
- Unimprinted throws available online
- Flame retardant certified for exhibit hall use

**White Imprint**

Item #	Description	3-5	6-11	12-24	25-49
116005	6' with White Imprint	119.60	112.40	106.40	93.25
116008	8' with White Imprint	125.90	118.30	112.00	98.15

**Setup fee: \$20(G)**

**Pricing is subject to change.**

Stock fabric colors imprinted with white imprint only. Minimum order quantity of 3.

USD MSRP (C)

Description	Table Size	Finished Graphic Size	Product Wt.
6'	standard 6'W table	view online template	3.75 lbs. (qty 3)
8'	standard 8'W table	view online template	4.5 lbs. (qty 3)

**Stock Value Lite Throw Colors**

- Black
- Hunter Green PMS 350
- Navy Blue PMS 2767
- Red PMS 201
- Royal Blue PMS 661

PMS colors are for reference only and may vary slightly from actual color.

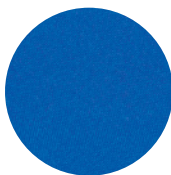

Lightweight, 100% woven polyester pongee.

STAIN-RESISTANT VALUE production lead time after final proof approval  
**3-4 DAYS**

**PRICES ARE SUBJECT TO CHANGE.** No setup fee on orders placed via our website.

Visit [showdowndisplays.com](http://showdowndisplays.com) for current pricing, graphic templates, product videos and assembly instructions. See pages 288-291 for order details.

SHOWDOWNDISPLAYS.COM · ASI 87188 · PPAI 254687 · SAGE 67383 · PPPC 20101202

## LIGHTWEIGHT TABLE THROW



This versatile and affordable table throw is a must have accessory for your next event.

- Available in 3-sided or 4-sided throw styles
- Artwork is dye sublimated on 4.4 oz. lightweight polyester knit
- Heat-treated edges will not fray or unravel
- Draped corners
- Machine-washable
- Flame retardant certified for exhibit hall use



### Full-Color Full-Bleed

Item #	Description	1	2-5	6-11	12-24
108300	6' Lightweight 3-Sided Throw	143.00	124.40	117.30	107.30
108301	8' Lightweight 3-Sided Throw	159.50	138.80	130.80	119.60
108302	6' Lightweight 4-Sided Throw	154.00	134.00	126.30	115.50
108303	8' Lightweight 4-Sided Throw	170.50	148.30	139.80	127.90

Setup fee: \$20(G)

Pricing is subject to change.

White fabric fully dye sublimated with full-color artwork.

USD MSRP (C)

Description	Table Size	Finished Graphic Size	Product Wt. (3-Sided / 4-Sided)
6'	standard 6'W table	view online template	2.4 lbs. / 3 lbs.
8'	standard 8'W table	view online template	3.2 lbs. / 4 lbs.



8' shown with 4-sides



6' shown with 4-sides



Laser-cut edges for a clean look.

## FITTED TABLE THROW



It's taut surfaces and sharp lines give it a tailored look that stands out at meetings, shows, career fairs and more.

- Available in full-color front only and full-color full-bleed
- Full-color front only features a large imprint area
- Tight, fitted look; covers four sides of the table
- Polyester poplin
- Machine-washable and wrinkle-resistant
- Flame retardant certified for exhibit hall use



### Full-Color Front Only

Item #	Description	1	2-5	6-11	12-24
115002	4' Fitted Demo Throw	230.10	200.20	188.70	172.60
107002	6' Fitted Throw	282.00	245.40	231.30	211.50
107014	8' Fitted Throw	307.50	267.50	252.25	230.70

Setup fee: \$20(G)

Pricing is subject to change.

Stock fabric colors with full-color artwork printed on front. Artwork cannot exceed maximum size requirements.

USD MSRP (C)

### Full-Color Full-Bleed

Item #	Description	1	2-5	6-11	12-24
115009	4' Fitted Demo Throw	230.10	200.20	188.70	172.60
107010	6' Fitted Throw	282.00	245.40	231.30	211.50
107022	8' Fitted Throw	307.50	267.50	252.25	230.70

Setup fee: \$20(G)

Pricing is subject to change.

White fabric fully dye sublimated with full-color artwork.

USD MSRP (C)

Description	Table Size	Finished Graphic Size	Product Wt.
4'	standard 4'W demo table	view online template	1.5 lbs.
6'	standard 6'W table	view online template	2 lbs.
8'	standard 8'W table	view online template	2.5 lbs.



8' full-color full-bleed



6' full-color front only shown in gray

**PRICES ARE SUBJECT TO CHANGE.** No setup fee on orders placed via our website. Visit [showdowndisplays.com](http://showdowndisplays.com) for current pricing, graphic templates, product videos and assembly instructions. See pages 288-291 for order details. SHOWDOWNDISPLAYS.COM · ASI 87188 · PPAI 254687 · SAGE 67383 · PPPC 20101202

LIGHTWEIGHT FITTED production lead time after final proof approval  
**2-OR-3 DAYS**



## OUTDOOR FITTED TABLE THROW



This heavy-duty throw can handle wind and spills, making it a perfect choice for outdoor events.

- Stays on the table, even in wind; see page 291 for information
- Tight, fitted look
- Covers four sides of the table
- Artwork is dye sublimated on 600 denier polyester
- Machine-washable
- Flame retardant certified for exhibit hall use

### Full-Color Full-Bleed

Item #	Description	1	2-5	6-11	12-24
107060	6' Outdoor Fitted Throw	419.50	365.00	344.00	314.50
107061	8' Outdoor Fitted Throw	470.50	428.00	409.25	385.75

Setup fee: \$20(G)

Pricing is subject to change.

White fabric fully dye sublimated with full-color artwork.

USD MSRP (C)

Description	Table Size	Finished Graphic Size	Product Wt.
6'	standard 6'W table	view online template	3.2 lbs.
8'	standard 8'W table	view online template	4.2 lbs.

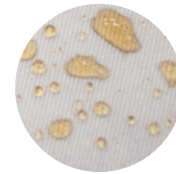

This throw is water- and spill-resistant by repelling liquids instead of absorbing them.

## FITTED ROUND TABLE THROW



This fitted table throw has a crisp, well-defined shape that makes a big impression at events.

- Fitted for round tables
- Available in full-color front only and full-color full-bleed
- Polyester poplin
- Machine-washable and wrinkle-resistant
- Flame retardant certified for exhibit hall use



Full-color full-bleed

Full-color front only shown in shamrock

### Full-Color Front Only

Item #	Description	1	2-5	6-11	12-24
107040	31.5" Bar-Height Fitted Round Throw	179.20	155.90	146.90	134.40

Setup fee: \$20(G)

Pricing is subject to change.

Stock fabric colors with full-color artwork printed on front. Artwork cannot exceed maximum size requirements.

USD MSRP (C)

### Full-Color Full-Bleed

Item #	Description	1	2-5	6-11	12-24
107047	31.5" Bar-Height Fitted Round Throw	179.20	155.90	146.90	134.40

Setup fee: \$20(G)

Pricing is subject to change.

White fabric fully dye sublimated with full-color artwork.

USD MSRP (C)

Table Size	Finished Graphic Size	Product Wt.
31.5"D bar-height table	view online template	1.5 lbs.

production lead time after final proof approval

**3 DAYS**

**PRICES ARE SUBJECT TO CHANGE.** No setup fee on orders placed via our website.

Visit [showdowndisplays.com](http://showdowndisplays.com) for current pricing, graphic templates, product videos and assembly instructions. See pages 288-291 for order details.

SHOWDOWNDISPLAYS.COM · ASI 87188 · PPAI 254687 · SAGE 67383 · PPPC 20101202



5'



4'



3'

## ROUND TABLE THROW



Whether you're showcasing products or hosting a banquet, this table throw adds style to any occasion.

- Draped, seamless look
- Artwork is dye sublimated on polyester poplin
- Machine-washable and wrinkle-resistant
- Flame retardant certified for exhibit hall use

### Full-Color Full-Bleed

Item #	Description	1	2-5	6-11	12-24
114040	31.5" Café-Height Round Throw	284.50	259.00	247.60	233.30
114041	31.5" Bar-Height Round Throw	307.50	279.75	267.50	252.25
114042	3' Round Throw	284.50	259.00	247.60	233.30
114043	4' Round Throw	307.50	279.75	267.50	252.25
114044	5' Round Throw	307.50	279.75	267.50	252.25

Setup fee: \$20(G)

Pricing is subject to change.

White fabric fully dye sublimated with full-color artwork.

USD MSRP (C)

Description	Table Size	Overhang	Finished Graphic Size	Product Wt.
31.5" café-height	31.5"D café-height table	27"	view online template	1.25 lbs.
31.5" bar-height	31.5"D bar-height table	33.25"	view online template	1.75 lbs.
3'	36"D café-height table	27"	view online template	1.5 lbs.
4'	48"D café-height table	25"	view online template	1.75 lbs.
5'	60"D café-height table	19"	view online template	1.75 lbs.

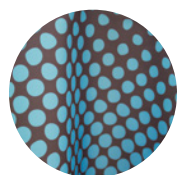

Artwork is seamless as it's draped around the table.



31.5" café-height



31.5" bar-height



28" full-color front only shown in peach



57" full-color full-bleed



12"



36"



Laser-cut edges for a clean look.

## LAZERLINE TABLE RUNNER



These cost-effective runners are laser-cut for a crisp finished edge.

- Available in full-color front only and full-color full-bleed
- Full-color front only features a large imprint area
- Heat-treated edges will not fray or unravel
- Polyester poplin
- Machine-washable and wrinkle-resistant
- Flame retardant certified for exhibit hall use
- Table throw sold separately

### Full-Color Front Only

Item #	Description	1	2-5	6-11	12-24
108224	28" LazerLine Runner	123.90	107.80	101.60	92.95
108225	57" LazerLine Runner	153.30	133.40	125.70	115.00

Setup fee: \$20(G)

Pricing is subject to change.

Stock fabric colors with full-color artwork printed on front. Artwork cannot exceed maximum size requirements.

USD MSRP (C)

### Full-Color Full-Bleed

Item #	Description	1	2-5	6-11	12-24
271272	12" LazerLine Runner	105.00	91.40	86.15	78.80
108226	28" LazerLine Runner	123.90	107.80	101.60	92.95
271273	36" LazerLine Runner	136.60	118.80	112.00	102.40
108227	57" LazerLine Runner	153.30	133.40	125.70	115.00

Setup fee: \$20(G)

Pricing is subject to change.

White fabric fully dye sublimated with full-color artwork.

USD MSRP (C)

Description	Finished Size	Finished Graphic Size	Product Wt.
12"	12"W x 72"D	view online template	0.25 lb.
28"	28"W x 80"D	view online template	0.5 lb.
36"	36"W x 72"D	view online template	0.5 lb.
57"	57"W x 80"D	view online template	1 lb.

production lead time after final proof approval

**2DAYS**

**PRICES ARE SUBJECT TO CHANGE.** No setup fee on orders placed via our website.

Visit [showdowndisplays.com](http://showdowndisplays.com) for current pricing, graphic templates, product videos and assembly instructions. See pages 288-291 for order details.

SHOWDOWNDISPLAYS.COM · ASI 87188 · PPAI 254687 · SAGE 67383 · PPPC 20101202



57" full-color front only shown in mango



28" full-color full-bleed

**Add-On**



**Table Throw Messenger Bag**  
Item #220107. See page 287.

**STANDARD TABLE RUNNER**



This stylish runner lets you add a logo or design to any table.

- Available in full-color front only and full-color full-bleed
- Full-color front only features a large imprint area
- Polyester poplin
- Machine-washable and wrinkle-resistant
- Flame retardant certified for exhibit hall use
- Table throw sold separately



28" full-color front only shown in white

**Full-Color Front Only**

Item #	Description	1	2-5	6-11	12-24
102002	28" Standard Runner	166.50	144.80	136.50	124.80
102014	57" Standard Runner	205.80	179.10	168.80	154.40

**Setup fee: \$20(G)**

**Pricing is subject to change.**

Stock fabric colors with full-color artwork printed on front.  
Artwork cannot exceed maximum size requirements.

USD MSRP (C)

**Full-Color Full-Bleed**

Item #	Description	1	2-5	6-11	12-24
102010	28" Standard Runner	166.50	144.80	136.50	124.80
102022	57" Standard Runner	205.80	179.10	168.80	154.40

**Setup fee: \$20(G)**

**Pricing is subject to change.**

White fabric fully dye sublimated with full-color artwork.

USD MSRP (C)

Description	Finished Size	Finished Graphic Size	Product Wt.
28"	28"W x 80"D	view online template	0.5 lb.
57"	57"W x 80"D	view online template	1 lb.



28" full-color full-bleed



# RETRACTABLE BANNERS

1. Plaza page 41 2. Deluxe Pro page 33 3. Jumbo Wide page 42

## have you considered...

- **use** will this product be used on a floor or on a tabletop?
- **flexibility** will your graphic be permanent or will you be swapping it out frequently?
- **frequency** how often will your retractor be set up and taken down?
- **location** will your retractor be used indoors or outdoors?
- **message** do you want a single- or double-sided display?

## how to **DISPLAY**

Retractable banners are great for their versatility, portability and reusability. Setting up a retractable banner is quick and easy, requiring minimal effort. Use at promotional events, conventions, product launches, food festivals, and corporate events.

# RETRACTABLE BANNER COMPARISON CHART

BEST SELLERS ★ SUSTAINABLE ◆		BANNER SIZES						FEATURES				BANNER MEDIA <small>(NOT ALL MEDIA IS AVAILABLE FOR ALL SIZES)</small>	RCAT RATING <small>MINIMUM RETRACTIONS</small>	HARDWARE WARRANTY	
GOOD	PG #	TABLE TOP	24"	31.5"	33.5"	36"	48"	TELESCOPING POLE	CHANGEABLE BANNER	ADJUSTABLE TENSION	2-SIDED OPTION				
Deluxe Mini ★	43	X											Polypropylene Media	-	6 months
Mini Promo ★	43	X											Polypropylene Media	-	6 months
Dual ◆	31			X	X	X					✓		No-Curl Hybrid Media · No-Curl Opaque Fabric PVC-Free Silver Backed Media	100	1 year
Economy ★ ◆	28	X	X	X	X	X	X						No-Curl Hybrid Media · No-Curl Opaque Fabric No-Curl Fabric (48" Only) · PVC-Free Silver Backed Media · Dry-Erase Media (Tabletop Only)	100	1 year
Ideal ★	31			X	X								Polypropylene Media	25	2 months
<b>NEW</b> LiteWay Economy	36	X	X	X		X							No-Curl Hybrid Media	100	6 months
<b>NEW</b> LiteWay Stratus	37		X	X		X		✓	✓				No-Curl Hybrid Media	200	6 months
Value ★	30			X	X	X							Polypropylene Media · No-Curl Hybrid Media	50	6 months
BETTER	PG #	24"	31.5"	33.5"	36"	46.5"	48"	TELESCOPING POLE	CHANGEABLE BANNER	ADJUSTABLE TENSION	2-SIDED OPTION			MINIMUM RETRACTIONS	
Deluxe Pro ★	33			X		X		✓	✓		✓		No-Curl Opaque Fabric · Dry-Erase Media	200	2 years
Economy Plus ★ ◆	32		X	X				✓	✓				No-Curl Hybrid Media · No-Curl Opaque Fabric · Dry-Erase Media	150	2 years
Stratus ★ ◆	34	X	X	X	X		X	✓	✓				No-Curl Hybrid Media No-Curl Opaque Fabric · Dry-Erase Media PVC-Free Silver Backed Media	200	2 years
BEST	PG #	31.25"	33.5"					TELESCOPING POLE	CHANGEABLE BANNER	ADJUSTABLE TENSION	2-SIDED OPTION			MINIMUM RETRACTIONS	
InstaChange	39				X			✓	✓				No-Curl Opaque Fabric	600	2 years
MagnaLink	39				X			✓	✓	✓			No-Curl Fabric	800	3 years
Spotlight	38		X								✓		Flexible Backlit Film	800	3 years
Superb	38				X			✓	✓	✓			No-Curl Hybrid Media	800	Lifetime
SPECIALTY	PG #	33.25"	5'	6'	8'			TELESCOPING POLE	CHANGEABLE BANNER	ADJUSTABLE TENSION	2-SIDED OPTION			MINIMUM RETRACTIONS	
Element	40	X						✓			✓		13 oz. Scrim Vinyl	150	1 year
Jumbo Wide	42			X	X	X							13 oz. Smooth Scrim Vinyl · No-Curl Fabric	100	1 year
Outdoor Trek Lite	40	X									✓		13 oz. Scrim Vinyl	250	1 year
Plaza	41	X											13 oz. Scrim Vinyl	200	1 year



**Beaufort Wind Rating:** See rating icon underneath the product name. Wind ratings were determined utilizing all available securing/stabilizing options sold with or offered for the product. See page 291 for details.



## AMERICA'S FINEST RETRACTOR

To guarantee superior quality, we have developed an RCAT (Retractor Calibration Assessment Test) machine that assesses retractable banner components. Each retractor is tested and rated to a minimum number of times it will extend and retract with normal use, helping you find a retractor that meets your exact needs. The RCAT rating certification lets you have confidence in your retractable banner display, no matter which one you choose.

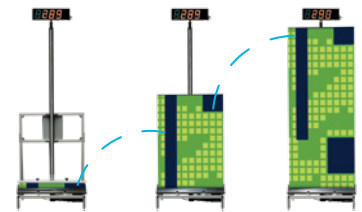

### Top Seller

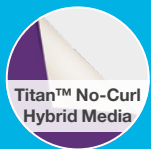

Anti-curl properties for a taut banner.

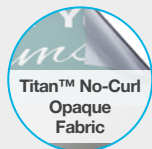

High-quality fabric that prevents curling. Silver backing makes it opaque.

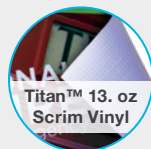

Durable vinyl repels water and cleans easily for extended outdoor use.

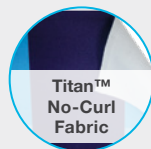

Lightweight, no-glare fabric prevents curling.



Smooth vinyl material, ideal for high-quality graphics.

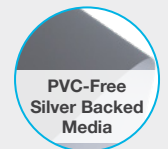

This media is an alternative to traditional vinyl as it does not contain polyvinyl (PVC).

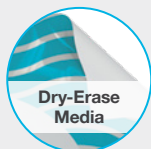

Smooth, glossy surface that can be written or drawn on with a dry-erase marker.

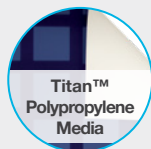

Tear-resistant matte media for temporary use.



Backlit film allows for light to shine through your artwork.

## ECONOMY RETRACTOR



A step above traditional entry-level displays, this best-selling retractable banner delivers professional-grade performance with a lightweight build and effortless setup.

- Lightweight aluminum base
- Banner available in Titan™ no-curl hybrid media, Titan™ no-curl opaque fabric, PVC-free silver backed media, Titan™ no-curl fabric (48" only), or dry-erase media (tabletop only)



Shock cord pole makes setup and teardown easy.



Banner rail easily attaches to the top of the pole for quick setup.

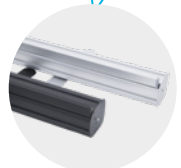

Hardware available in silver or black.

24" with single light kit (sold separately)

### Add-Ons



#### Retractor Hard Case

Item #	Description	1	2-5	6-11	12-24
220129	Hard Case	94.80	89.15	85.35	79.65

Pricing is subject to change.

Holds Economy retractors up to 36" wide

USD MSRP (C)



#### Ultimate LED Single Light Kit

Item #	Description	1	2-5	6-11	12-24
150120	Kit	199.50	193.50	187.50	181.50

Pricing is subject to change.

USD MSRP (C)



Two swivel feet for stability (18" tabletop has one swivel foot).



24" and 18" tabletop on a 6' Standard throw shown in orange (sold separately; see page 12)

**Tabletop Economy Retractor**

Item #	Description	1	2-5	6-11	12-24
261380	18" No-Curl Hybrid Media Kit	147.20	141.30	134.00	126.60
261381	18" No-Curl Opaque Fabric Kit	147.20	141.30	134.00	126.60
261382	18" PVC-Free Silver Backed Media Kit	147.20	141.30	134.00	126.60
261430	18" Dry-Erase Media Kit	147.20	141.30	134.00	126.60
261130	24" No-Curl Hybrid Media Kit	180.20	173.00	164.00	155.00
262160	24" No-Curl Opaque Fabric Kit	180.20	173.00	164.00	155.00
261360	24" PVC-Free Silver Backed Media Kit	180.20	173.00	164.00	155.00
261431	24" Dry-Erase Media Kit	180.20	173.00	164.00	155.00

**Setup fee: \$20(G)** **Pricing is subject to change.**  
 Kit Includes: Silver or Black Hardware, Installed Graphic and Soft Carry Case USD MSRP (C)

**Economy Retractor**

Item #	Description	1	2-5	6-11	12-24
261132	24" No-Curl Hybrid Media Kit	254.00	243.80	231.10	218.40
262161	24" No-Curl Opaque Fabric Kit	254.00	243.80	231.10	218.40
261362	24" PVC-Free Silver Backed Media Kit	254.00	243.80	231.10	218.40
261134	31.5" No-Curl Hybrid Media Kit	290.25	278.50	264.00	249.60
262162	31.5" No-Curl Opaque Fabric Kit	290.25	278.50	264.00	249.60
261364	31.5" PVC-Free Silver Backed Media Kit	290.25	278.50	264.00	249.60
261136	33.5" No-Curl Hybrid Media Kit	300.75	288.75	273.50	258.50
262163	33.5" No-Curl Opaque Fabric Kit	300.75	288.75	273.50	258.50
261366	33.5" PVC-Free Silver Backed Media Kit	300.75	288.75	273.50	258.50
261138	36" No-Curl Hybrid Media Kit	335.75	322.50	305.50	288.75
262164	36" No-Curl Opaque Fabric Kit	335.75	322.50	305.50	288.75
261368	36" PVC-Free Silver Backed Media Kit	335.75	322.50	305.50	288.75
261140	48" No-Curl Hybrid Media Kit	359.25	345.00	327.00	309.00
262165	48" No-Curl Opaque Fabric Kit	359.25	345.00	327.00	309.00
261370	48" PVC-Free Silver Backed Media Kit	359.25	345.00	327.00	309.00
262300	48" No-Curl Fabric Green Screen Kit	407.75	383.25	367.00	342.50

**Setup fee: \$20(G)** **Pricing is subject to change.**  
 Kit Includes: Silver or Black Hardware, Installed Graphic and Soft Carry Case USD MSRP (C)

Description	Product Size	Finished Graphic Size	Product Wt.
18" tabletop	19"W x 28"H x 11"D	view online template	5.4 lbs.
24" tabletop	24.75"W x 39"H x 11"D	view online template	5.5 lbs.
24"	24.75"W x 83.5"H x 11"D	view online template	6 lbs.
31.5"	32"W x 83.5"H x 15"D	view online template	7 lbs.
33.5"	34"W x 83.5"H x 15"D	view online template	7.25 lbs.
36"	36.5"W x 83.5"H x 15"D	view online template	8.5 lbs.
48"	48"W x 83.5"H x 15"D	view online template	11.25 lbs.

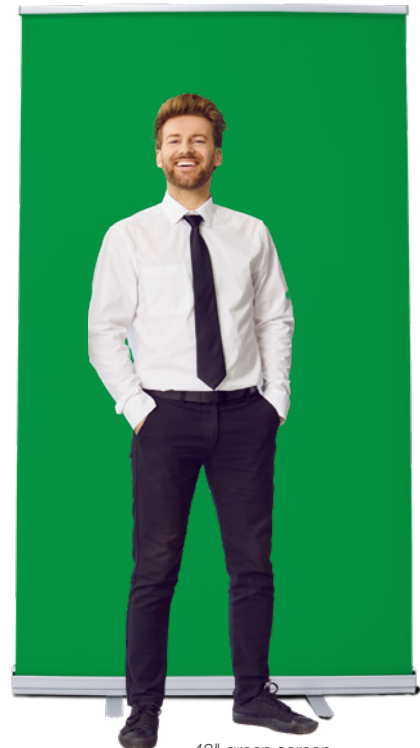

48" green screen

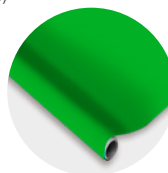

Green screen compatible backdrop is printed as PMS 354C.



The sustainable display option uses PVC-free media with the recyclable aluminum base.

**HARDWARE-ONLY LEAD TIME: SHIPS SAME DAY WHEN ORDERED BEFORE 2 PM CENTRAL**  
**PRICES ARE SUBJECT TO CHANGE.** No setup fee on orders placed via our website.  
 Visit [showdowndisplays.com](http://showdowndisplays.com) for current pricing, graphic templates, product videos and assembly instructions. See pages 288-291 for order details.  
 SHOWDOWNDISPLAYS.COM · ASI 87188 · PPAI 254687 · SAGE 67383 · PPPC 20101202

GREEN SCREEN production lead time after final proof approval  
**24-DAYS**

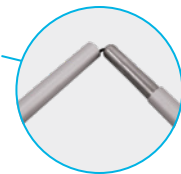

Shock cord pole makes setup and teardown easy.

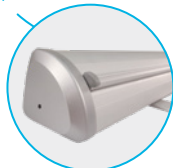

Lightweight aluminum base with plastic ends.

**VALUE RETRACTOR**



The Value Retractor is a cost-conscious option for your portable signage needs.

- Banner available in Titan™ polypropylene media or Titan™ no-curl hybrid media
- Two swivel feet for stability
- Available in three widths

**Value Retractor**

Item #	Description	1	2-5	6-11	12-24
262240	31.5" Polypropylene Media Kit	184.80	177.40	168.20	159.00
262241	31.5" No-Curl Hybrid Media Kit	245.20	235.40	223.10	210.90
262243	33.5" Polypropylene Media Kit	193.90	186.10	176.40	166.70
262244	33.5" No-Curl Hybrid Media Kit	260.75	250.50	237.30	224.30
262246	36" Polypropylene Media Kit	196.60	188.70	178.90	169.00
262247	36" No-Curl Hybrid Media Kit	271.00	260.25	246.70	233.10

**Setup fee: \$20(G)** **Pricing is subject to change.**  
 Kit Includes: Hardware, Installed Graphic and Soft Carry Case USD MSRP (C)

Description	Product Size	Finished Graphic Size	Product Wt.
31.5"	34"W x 82"H x 15"D	view online template	7 lbs.
33.5"	35.75"W x 82"H x 15"D	view online template	7.25 lbs.
36"	38.5"W x 82"H x 15"D	view online template	7.6 lbs.



production lead time after final proof approval

**2DAYS**

## IDEAL RETRACTOR



The Ideal Retractor is designed from the ground up to be a quick, simple solution for short-term promotional applications.

- Lightweight, portable base
- Three-section shock cord pole
- Plastic swivel foot for stability
- Available in two widths
- Artwork is printed on tear-resistant Titan™ polypropylene media
- Not eligible for Rush Service

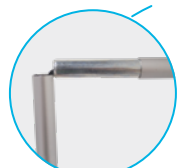

Shock cord pole makes setup and teardown easy.



31.5"

33.5"

### Ideal Retractor

Item #	Description	1	2-5	6-11	12-24
261150	31.5" Kit	151.20	142.10	136.10	127.00
261153	33.5" Kit	165.80	155.90	149.20	139.30

Setup fee: \$20(G)

Pricing is subject to change.

Kit Includes: Hardware, Installed Graphic and Soft Carry Case

USD MSRP (C)

Description	Product Size	Finished Graphic Size	Product Wt.	Media
31.5"	32.25"W x 82.25"H x 10.25"D	view online template	4.6 lbs.	Titan™ polypropylene media
33.5"	34.25"W x 82.25"H x 10.25"D	view online template	5 lbs.	Titan™ polypropylene media



Banner rail easily attaches to the top of the pole for quick setup.



Lightweight aluminum base features plastic ends.

## DUAL RETRACTOR



Get double the advertising power with this retractable banner display.

- Banner available in Titan™ no-curl hybrid media, Titan™ no-curl opaque fabric or PVC-free silver backed media
- Lightweight aluminum base
- Two swivel feet for stability
- Available in three widths
- Shock cord pole makes setup and teardown easy
- Retractor features two single-sided banners
- Banners attach with snap rail on top and banner tape on bottom

### Dual Retractor

Item #	Description	1	2-5	6-11	12-24
261400	31.5" No-Curl Hybrid Media Kit	389.50	381.25	349.00	340.75
261401	31.5" No-Curl Opaque Fabric Kit	389.50	381.25	349.00	340.75
261402	31.5" PVC-Free Silver Backed Media Kit	389.50	381.25	349.00	340.75
261407	33.5" No-Curl Hybrid Media Kit	405.50	396.75	363.25	354.75
261408	33.5" No-Curl Opaque Fabric Kit	405.50	396.75	363.25	354.75
261409	33.5" PVC-Free Silver Backed Media Kit	405.50	396.75	363.25	354.75
261414	36" No-Curl Hybrid Media Kit	421.50	412.50	377.75	368.75
261415	36" No-Curl Opaque Fabric Kit	421.50	412.50	377.75	368.75
261416	36" PVC-Free Silver Backed Media Kit	421.50	412.50	377.75	368.75

Setup fee: \$20(G)

Pricing is subject to change.

Kit Includes: Hardware, 2 Installed Graphics and Soft Carry Case

USD MSRP (C)

Description	Product Size	Finished Graphic Size	Product Wt.
31.5"	32.375"W x 83.375"H x 15"D	view online template	11.2 lbs.
33.5"	34.375"W x 83.375"H x 15"D	view online template	11.8 lbs.
36"	36.875"W x 83.375"H x 15"D	view online template	14 lbs.

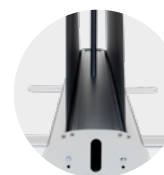

View artwork from the front and back of the retractor for twice the messaging power.

PRICES ARE SUBJECT TO CHANGE. No setup fee on orders placed via our website.

Visit [showdowndisplays.com](http://showdowndisplays.com) for current pricing, graphic templates, product videos and assembly instructions. See pages 288-291 for order details.

SHOWDOWNDISPLAYS.COM · ASI 87188 · PPAI 254687 · SAGE 67383 · PPPC 20101202

IDEAL DUAL production lead time after final proof approval  
-OR- 1-2 DAYS



33.5"

31.5"



**Dry-Erase Media**

Dry-erase media is both fun and functional. It features a glossy surface that has the write-on/wipe-off utility of a dry-erase board (dry-erase markers not included).



Banner rail easily attaches to the top of the pole for quick setup.



Hook-and-loop fasteners make banners easy to swap out.

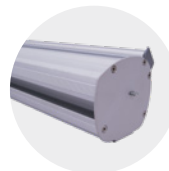

Heavy-duty aluminum base available in silver.



**ECONOMY PLUS RETRACTOR**



This display elevates our popular Economy Retractor with improved durability and additional features.

- Available in two widths
- Single-footed design keeps the retractor stable while maintaining a low profile
- Flip-lever telescoping pole makes setup and adjustment simple
- Banner available in Titan™ no-curl hybrid media, Titan™ no-curl opaque fabric or dry-erase media

**Economy Plus Retractor**

Item #	Description	1	2-5	6-11	12-24
261012	31.5" No-Curl Hybrid Media Kit	361.75	340.25	325.75	304.00
262180	31.5" No-Curl Opaque Fabric Kit	361.75	340.25	325.75	304.00
262191	31.5" Dry-Erase Media Kit	361.75	340.25	325.75	304.00
261002	33.5" No-Curl Hybrid Media Kit	381.00	358.25	343.00	320.00
262181	33.5" No-Curl Opaque Fabric Kit	381.00	358.00	342.75	320.00
262192	33.5" Dry-Erase Media Kit	381.00	358.00	342.75	320.00

Setup fee: \$20(G)

Pricing is subject to change.

Kit Includes: Hardware, Installed Graphic and Soft Carry Case

USD MSRP (C)

Description	Product Size	Finished Graphic Size	Product Wt.
31.5"	32"W x 64"-82.5"H x 15"D	view online template	7 lbs.
33.5"	34"W x 64"-82.5"H x 15"D	view online template	7.5 lbs.

production lead time after final proof approval

**2DAYS**

**PRICES ARE SUBJECT TO CHANGE.** No setup fee on orders placed via our website. Visit [showdowndisplays.com](http://showdowndisplays.com) for current pricing, graphic templates, product videos and assembly instructions. See pages 288-291 for order details.

SHOWDOWNDISPLAYS.COM · ASI 87188 · PPAI 254687 · SAGE 67383 · PPPC 20101202



## DELUXE PRO RETRACTOR



The Deluxe Pro Retractor features a curved base with durable aluminum end caps. Swapping out graphics is a breeze with the hook-and-loop banner system.

- Available in two widths
- Banner available in Titan™ no-curl opaque fabric or dry-erase media
- Banner is printed single-sided; double-sided option includes two banners
- No-curl opaque fabric is not eligible for Rush Service

### Deluxe Pro Retractor

Item #	Description	1	2-5	6-11	12-24
262250	33.5" Single No-Curl Opaque Fabric Kit	394.00	370.50	354.75	331.00
262251	33.5" Double No-Curl Opaque Fabric Kit	595.50	580.50	533.50	518.50
262202	33.5" Single Dry-Erase Media Kit	394.00	370.50	354.75	331.00
262203	33.5" Double Dry-Erase Media Kit	595.50	580.50	533.50	518.50
262254	46.5" Single No-Curl Opaque Fabric Kit	528.00	496.50	475.50	443.75
262255	46.5" Double No-Curl Opaque Fabric Kit	779.50	758.50	699.00	677.50
262204	46.5" Single Dry-Erase Media Kit	528.00	496.50	475.50	443.75
262205	46.5" Double Dry-Erase Media Kit	779.50	758.50	699.00	677.50

Setup fee: \$20(G)

Pricing is subject to change.

Kit Includes: Hardware, Installed Graphic(s) and Soft Carry Case

USD MSRP (C)

Description	Product Size (Single / Double)	Finished Graphic Size	Product Wt. (Single / Double)
33.5"	34.75"W x 65.25"H x 8.5"D / 9.25"D	view online template	12.25 lbs. / 16 lbs.
46.5"	48.5"W x 65.25"H x 8.5"D / 9.25"D	view online template	16.75 lbs. / 22.5 lbs.



Flip-lever telescoping pole makes setup and adjustment simple.



Hook-and-loop fasteners make banners easy to swap out.



Streamlined base is available in single- and double-banner options.

### Dry-Erase Media

Dry-erase media is both fun and functional. It features a glossy surface that has the write-on/wipe-off utility of a dry-erase board (dry-erase markers not included).



**PRICES ARE SUBJECT TO CHANGE.** No setup fee on orders placed via our website. Visit [showdowndisplays.com](http://showdowndisplays.com) for current pricing, graphic templates, product videos and assembly instructions. See pages 288-291 for order details. SHOWDOWNDISPLAYS.COM · ASI 87188 · PPAI 254687 · SAGE 67383 · PPPC 20101202

FABRIC DRY-ERASE production lead time after final proof approval  
**1-14 DAYS**

## STRATUS RETRACTOR



The Stratus Retractor's streamlined base features a low center of gravity to keep it stable, eliminating the need for fold-out feet.

- Durable, lightweight construction
- Banner available in Titan™ no-curl hybrid media, Titan™ no-curl opaque fabric, dry-erase media or PVC-free silver backed media



Our sustainable display option uses PVC-free media and includes the recyclable aluminum base.

48"

36"

33.5"

31.5"

24"

Aluminum base features chrome end caps and has a low center of gravity.



PVC-free silver backed media is free of heavy metals and phthalates. See website for more information.



**Stratus Retractor**

Item #	Description	1	2-5	6-11	12-24
262070	24" No-Curl Hybrid Media Kit	344.00	323.25	309.50	289.00
262150	24" No-Curl Opaque Fabric Kit	344.00	323.25	309.50	289.00
261460	24" PVC-Free Silver Backed Media Kit	344.00	323.25	309.50	289.00
262206	24" Dry-Erase Media Kit	344.00	323.25	309.50	289.00
262072	31.5" No-Curl Hybrid Media Kit	392.75	369.25	353.50	330.00
262151	31.5" No-Curl Opaque Fabric Kit	392.75	369.25	353.50	330.00
261461	31.5" PVC-Free Silver Backed Media Kit	392.75	369.25	353.50	330.00
262207	31.5" Dry-Erase Media Kit	392.75	369.25	353.50	330.00
262074	33.5" No-Curl Hybrid Media Kit	407.75	383.50	367.00	342.50
262152	33.5" No-Curl Opaque Fabric Kit	407.75	383.50	367.00	342.50
261462	33.5" PVC-Free Silver Backed Media Kit	407.75	383.50	367.00	342.50
262208	33.5" Dry-Erase Media Kit	407.75	383.50	367.00	342.50
262076	36" No-Curl Hybrid Media Kit	433.75	407.75	390.25	364.25
262153	36" No-Curl Opaque Fabric Kit	433.75	407.75	390.25	364.25
261463	36" PVC-Free Silver Backed Media Kit	433.75	407.75	390.25	364.25
262209	36" Dry-Erase Media Kit	433.75	407.75	390.25	364.25
262078	48" No-Curl Hybrid Media Kit	480.25	451.50	432.25	403.50
262154	48" No-Curl Opaque Fabric Kit	480.25	451.50	432.25	403.50
261464	48" PVC-Free Silver Backed Media Kit	480.25	451.50	432.25	403.50
262210	48" Dry-Erase Media Kit	480.25	451.50	432.25	403.50

Setup fee: \$20(G)

Pricing is subject to change.

Kit Includes: Hardware, Installed Graphic and Soft Carry Case

USD MSRP (C)

Description	Product Size	Finished Graphic Size	Product Wt.
24"	25.25"W x 67.5"-81.625"H x 7.125"D	view online template	8.75 lbs.
31.5"	33"W x 67.5"-81.625"H x 7.125"D	view online template	11.25 lbs.
33.5"	34.25"W x 67.5"-81.625"H x 7.125"D	view online template	12 lbs.
36"	37.25"W x 67.5"-81.625"H x 7.125"D	view online template	12.5 lbs.
48"	49.5"W x 67.5"-81.625"H x 7.125"D	view online template	17.25 lbs.



Banner rail easily attaches to the top of the pole for quick setup.

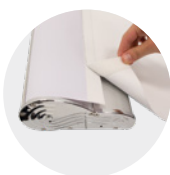

Hook-and-loop fasteners make banners easy to swap out.



Shock cord pole with telescoping flip-lever extension makes setup and adjustment simple.

**Dry-Erase Media**

Dry-erase media is both fun and functional. It features a glossy surface that has the write-on/wipe-off utility of a dry-erase board (dry-erase markers not included).



**PRICES ARE SUBJECT TO CHANGE.** No setup fee on orders placed via our website. Visit [showdowndisplays.com](http://showdowndisplays.com) for current pricing, graphic templates, product videos and assembly instructions. See pages 288-291 for order details.

SHOWDOWNDISPLAYS.COM · ASI 87188 · PPAI 254687 · SAGE 67383 · PPPC 20101202

production lead time after final proof approval  
**2 DAYS**



36"

31.5"

24"



24" tabletop shown on 6' Standard throw shown in hot pink (sold separately; see page 12)



### LITEWAY ECONOMY RETRACTOR



Our best-selling Economy Retractor comes in a durable, PVC option alongside the classic aluminum version. Perfect for budget-focused campaigns.

- Available in three widths
- Featuring black PVC construction for cost-efficient production
- Shock cord pole makes setup and teardown easy
- Banner available in Titan™ no-curl hybrid media

#### LiteWay Economy Retractor

Item #	Description	1	2-5	6-11	12-24
261434	24" Tabletop Kit	120.00	112.80	108.00	100.80
261436	24" Kit	140.00	131.60	126.00	117.60
261438	31.5" Kit	182.00	171.10	163.80	152.90
261440	36" Kit	225.00	211.50	202.50	189.00

Setup fee: \$20(G)

Pricing is subject to change.

Kit Includes: Black Hardware, Installed Graphic and Soft Carry Case USD MSRP (C)

Description	Product Size	Finished Graphic Size	Product Wt.	Media
24" tabletop	24.75"W x 39"H x 11"D	view online template	5.8 lbs.	Titan™ no-curl hybrid media
24"	24.75"W x 83.5"H x 11"D	view online template	7.2 lbs.	Titan™ no-curl hybrid media
31.5"	32"W x 83.5"H x 15"D	view online template	8.8 lbs.	Titan™ no-curl hybrid media
36"	36.5"W x 83.5"H x 15"D	view online template	9.2 lbs.	Titan™ no-curl hybrid media



Banner rail easily attaches to the top of the pole for quick setup.



Two swivel feet for stability.

production lead time after final proof approval

**2DAYS**

PRICES ARE SUBJECT TO CHANGE. No setup fee on orders placed via our website. Visit [showdowndisplays.com](http://showdowndisplays.com) for current pricing, graphic templates, product videos and assembly instructions. See pages 288-291 for order details.

SHOWDOWNDISPLAYS.COM · ASI 87188 · PPAI 254687 · SAGE 67383 · PPPC 20101202



Banner rail easily attaches to the top of the pole for quick setup.



## LITEWAY STRATUS RETRACTOR



Our popular Stratus Retractor comes in a durable, white PVC option alongside the classic aluminum version.

Making it a reliable and budget-friendly display solution.

- Available in three widths
- White PVC construction for cost-efficient production
- Shock cord pole with telescoping flip-lever extension makes setup and adjustment simple
- Banner attaches with snap rail on top; attaches with hook-and-loop on bottom
- Banner available in Titan™ no-curl hybrid media

### LiteWay Stratus Retractor

Item #	Description	1	2-5	6-11	12-24
261470	24" Kit	260.74	245.01	234.60	218.88
261472	31.5" Kit	312.38	293.68	281.14	262.44
261474	36" Kit	350.41	329.38	315.35	294.31

Setup fee: \$20(G)

Pricing is subject to change.

Kit Includes: White Hardware, Installed Graphic and Soft Carry Case

USD MSRP (C)

Description	Product Size	Finished Graphic Size	Product Wt.	Media
24"	25.25"W x 67.5"-81.625"H x 7.125"D	view online template	9.2 lbs.	Titan™ no-curl hybrid media
31.5"	33"W x 67.5"-81.625"H x 7.125"D	view online template	10.7 lbs.	Titan™ no-curl hybrid media
36"	37.25"W x 67.5"-81.625"H x 7.125"D	view online template	11.8 lbs.	Titan™ no-curl hybrid media



Base is constructed from white PVC.

**PRICES ARE SUBJECT TO CHANGE.** No setup fee on orders placed via our website. Visit [showdowndisplays.com](http://showdowndisplays.com) for current pricing, graphic templates, product videos and assembly instructions. See pages 288-291 for order details. SHOWDOWNDISPLAYS.COM · ASI 87188 · PPAI 254687 · SAGE 67383 · PPPC 20101202

production lead time after final proof approval  
**2DAYS**



## SUPERB RETRACTOR



This retractor features a flip-open base for easy graphic changes, and its hardware is built to last a lifetime.

- Durable construction makes this a long-lasting option
- Artwork is printed on Titan™ no-curl hybrid media
- Not eligible for Rush Service

### Superb Retractor

Item #	Description	1	2-5	6-11	12-24
261118	Kit	523.50	492.25	471.25	439.75
262023	Banner and Roller	334.00	314.00	300.50	280.50

Setup fee: \$20(G)

Pricing is subject to change.

Kit Includes: Hardware, Installed Graphic and Soft Carry Case

USD MSRP (C)

Product Size	Finished Graphic Size	Product Wt.	Media
35.5"W x 37"-80.5"H x 7.75"D	view online template	8 lbs.	Titan™ no-curl hybrid media



Flip-lever telescoping pole makes setup and adjustment simple.



Flip-open base allows for easy banner changes.



Low-profile base is available with black or silver ends.



## SPOTLIGHT RETRACTOR



Illuminate the possibilities at your next event with this LED lit retractor.

- Has the look of a light box with the portability, convenience and easy setup of a retractable banner
- Artwork is printed on flexible backlit film
- Light is radiated from the base by LED lights
- Retractor features two single-sided banners
- Illuminate up to three units via a single power source with the included connector cords
- On/off switch for the lights is located on the side of the base
- UL/CE certified
- US Patent #201920486314.5

### Spotlight Retractor

Item #	Description	1	2-5	6-11	12-24
261304	Kit	785.00	737.50	706.50	659.00

Setup fee: \$20(G)

Pricing is subject to change.

Kit Includes: Hardware, 2 Installed Graphics and Soft Carry Case

USD MSRP (C)

Product Size	Finished Graphic Size	Product Wt.	Media
34"W x 84"H x 10.25"D	view online template	22 lbs.	flexible backlit film



Connector cord can be used to link retractors together.



LED lights integrated into the base provide illumination.



Hardware holds two banners for a double-sided display.



Shock cord pole makes setup and takedown easy.

SUPERB SPOTLIGHT production lead time after final proof approval  
**1-OR-2 DAYS**

## INSTACHANGE RETRACTOR



Spruce up your environment with this modern retractor that allows for easily changing your message on the fly.

- Artwork is printed on Titan™ no-curl opaque fabric
- Flip-lever telescoping pole makes setup and adjustment simple
- Easy-to-install replaceable graphic cartridge
- Hardware available in high-gloss black or white base

### InstaChange Retractor

Item #	Description	1	2-5	6-11	12-24
261340	Kit	629.50	591.50	566.50	528.50
261342	Cartridge Kit	209.80	197.20	188.80	176.20

Setup fee: \$20(G)

Pricing is subject to change.

Kit Includes: Black or White Hardware, Installed Graphic and Soft Carry Case USD MSRP (C)  
 Cartridge Kit Includes: Cartridge, Installed Graphic and Snap Rail

Product Size	Finished Graphic Size	Product Wt.	Media
35.125"W x 63.875"-88.25"H x 8.625"D	view online template	14 lbs.	Titan™ no-curl opaque fabric



white base



black base



Shock cord pole with telescoping flip-lever extension makes setup and adjustment simple.



Sleek-looking cartridge is inserted into the base for convenient banner changes.



Base unlocks with a simple twist to release the cartridge.



Simply lift to remove cartridge for easy banner replacement.

## MAGNALINK RETRACTOR



This retractor features magnetic end caps so you can link several banners and create an extra-wide display.

- Artwork is dye sublimated on Titan™ no-curl fabric
- Footless base creates a discreet appearance
- When connected, there will be a 1" gap between banners

### MagnaLink Retractor

Item #	Description	1	2-5	6-11	12-24
261210	Kit	531.00	499.25	478.00	446.25

Setup fee: \$20(G)

Pricing is subject to change.

Kit Includes: Hardware, Installed Graphic and Soft Carry Case USD MSRP (C)

Product Size	Finished Graphic Size	Product Wt.	Media
34.75"W x 31.75"-91.75"H x 8.5"D	view online template	13 lbs.	Titan™ no-curl fabric



Hook-and-loop fasteners make banners easy to swap out.



Magnetic end caps on base and top rail keep multiple units aligned for a professional appearance.



Flip-lever telescoping pole makes setup and adjustment simple.



Three-section flip lever telescoping pole makes setup and adjustment simple.

## ELEMENT RETRACTOR



Hidden between this retractor's banners is a sturdy ballast that utilizes water or sand to keep the display stable for outdoor use.

- Artwork is printed on Titan™ 13 oz. scrim vinyl
- Retractor features two single-sided banners
- Ballast holds up to 2.6 gallons of water; weighs 25 lbs. when filled
- Banners used outdoors have a 90-day warranty; banners used indoors have a 1-year warranty

### Element Retractor

Item #	Description	1	2-5	6-11	12-24
261270	Kit	666.50	626.50	600.00	560.00

Setup fee: \$20(G)

Pricing is subject to change.

Kit Includes: Hardware, 2 Installed Graphics, 4 Stakes and Soft Carry Case

USD MSRP (C)

Product Size	Finished Graphic Size	Product Wt.	Media
34.5"W x 38.75"-81.5"H x 20.5"D	view online template	22.5 lbs.	Titan™ 13 oz. scrim vinyl



Feet pull out for added stability in outdoor conditions.



Includes four stakes to secure feet to the ground.



Removable ballast can be filled with water or sand to keep display stable outdoors.



## OUTDOOR TREK LITE RETRACTOR



This retractor's large removable feet keep it stable in the wind, making it perfect for temporary outdoor use.

- Shock cord pole for easy assembly
- Artwork is printed on Titan™ 13 oz. scrim vinyl
- Retractor features two single-sided banners
- Banners used outdoors have a 90-day warranty; banners used indoors have a 1-year warranty

### Outdoor Trek Lite Retractor

Item #	Description	1	2-5	6-11	12-24
263040	Kit	605.00	588.00	542.50	525.50

Setup fee: \$20(G)

Pricing is subject to change.

Kit Includes: Hardware, 2 Installed Graphics, 4 Stakes and Soft Carry Case

USD MSRP (C)

Product Size	Finished Graphic Size	Product Wt.	Media
35.75"W x 82.25"H x 32.25"D	view online template	22.75 lbs.	Titan™ 13 oz. scrim vinyl



Includes four stakes to secure feet to the ground.

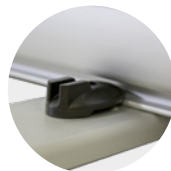

Removable feet attach securely to the base for a stable footprint.



Heavy-duty base with black end caps.

production lead time after final proof approval

**2DAYS**

**PRICES ARE SUBJECT TO CHANGE.** No setup fee on orders placed via our website.

Visit [showdowndisplays.com](http://showdowndisplays.com) for current pricing, graphic templates, product videos and assembly instructions. See pages 288-291 for order details.

SHOWDOWNDISPLAYS.COM · ASI 87188 · PPAI 254687 · SAGE 67383 · PPPC 20101202



## PLAZA RETRACTOR



Elevate your outdoor message with this compact, weather-resistant display.

- Artwork is printed on Titan™ 13 oz. scrim vinyl
- Integrated three-piece ballast; each ballast holds 11 lbs. of sand or 0.8 gallons of water
- Three-section shock cord pole for easy assembly
- Banner attaches with adhesive plastic strips that slide into both the top rail and base
- Banners used outdoors have a 90-day warranty; banners used indoors have a 1-year warranty

### Plaza Retractor

Item #	Description	1	2-5	6-11	12-24
261500	Kit	448.50	421.50	403.75	376.75

Setup fee: \$20(G)

Pricing is subject to change.

Kit Includes: Hardware, Installed Graphic and Soft Carry Case USD MSRP (C)

Product Size	Finished Graphic Size	Product Wt.	Media
36.25"W x 81.625"H x 14.25"D	view online template	10.8 lbs.	Titan™ 13 oz. scrim vinyl



Lightweight, low-profile silver base.



Tighten screw to secure swivel foot to base.



Top rail is folded back to conceal the hardware for a sleek look.

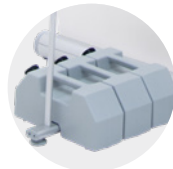

The three-piece ballast base provides stability with a small footprint.



Removable ballasts can be filled with water or sand to keep display stable outdoors.

front view

**PRICES ARE SUBJECT TO CHANGE.** No setup fee on orders placed via our website. Visit [showdowndisplays.com](http://showdowndisplays.com) for current pricing, graphic templates, product videos and assembly instructions. See pages 288-291 for order details. SHOWDOWNDISPLAYS.COM · ASI 87188 · PPAI 254687 · SAGE 67383 · PPPC 20101202

production lead time after final proof approval  
**2DAYS**

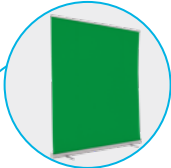

Printed as PMS 354C for a green screen compatible backdrop.

### JUMBO WIDE RETRACTOR



Create an impressive backdrop with this ultra-wide retractable banner.

- High-tension base springs keep the banner taut
- Double-footed design for stability
- Banner available in Titan™ no-curl fabric or Titan™ 13 oz. smooth scrim vinyl
- Available in three widths

#### Jumbo Wide Retractor

Item #	Description	1	2-5	6-11	12-24
262138	5' No-Curl Fabric Kit	783.50	736.50	705.00	658.00
261080	5' 13 oz. Smooth Scrim Vinyl Kit	783.50	736.50	705.00	658.00
262304	5' No-Curl Fabric Green Screen Kit	783.50	736.50	705.00	658.00
262139	6' No-Curl Fabric Kit	947.00	890.50	852.50	795.50
261082	6' 13 oz. Smooth Scrim Vinyl Kit	947.00	890.50	852.50	795.50
262308	6' No-Curl Fabric Green Screen Kit	947.00	890.50	852.50	795.50
262140	8' No-Curl Fabric Kit	1107.00	1040.00	996.00	929.50
261018	8' 13 oz. Smooth Scrim Vinyl Kit	1107.00	1040.00	996.00	929.50
262312	8' No-Curl Fabric Green Screen Kit	1107.00	1040.00	996.00	929.50

Setup fee: \$20(G)

Pricing is subject to change.

Kit Includes: Hardware, Installed Graphic and Soft Carry Case

USD MSRP (C)

Description	Product Size	Finished Graphic Size	Product Wt. (Fabric / Vinyl)
5'	60.5"W x 83"H x 15.75"D	view online template	18.85 lbs. / 20.75 lbs.
6'	72.5"W x 83"H x 15.75"D	view online template	21.35 lbs. / 23.5 lbs.
8'	95.5"W x 83"H x 15.75"D	view online template	26.35 lbs. / 29.5 lbs.

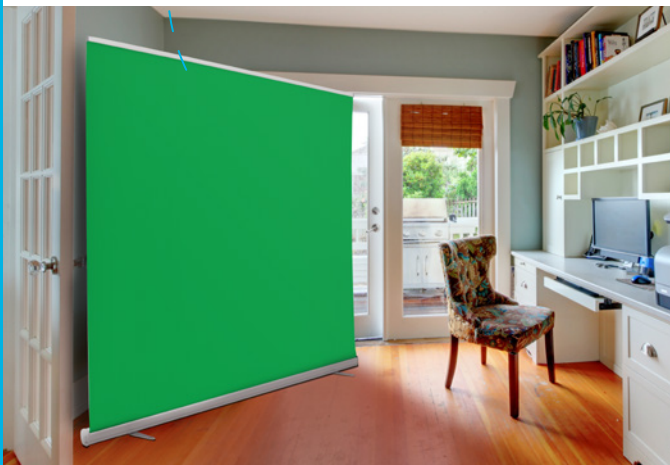

Two shock cord poles support the banner.

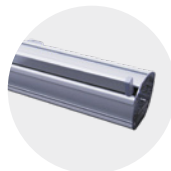

Hardware is available in silver.

VINYL FABRIC production lead time after final proof approval  
**24 DAYS**  
 -OR-

**PRICES ARE SUBJECT TO CHANGE.** No setup fee on orders placed via our website. Visit [showdowndisplays.com](http://showdowndisplays.com) for current pricing, graphic templates, product videos and assembly instructions. See pages 288-291 for order details.

SHOWDOWNDISPLAYS.COM · ASI 87188 · PPAI 254687 · SAGE 67383 · PPPC 20101202

**NEW  
PRODUCT**



18" Economy



24" LiteWay Economy



Deluxe Mini



Small Mini Promo

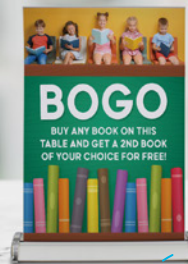

Large Mini Promo

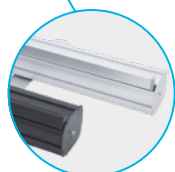

Economy hardware available in silver or black.



Hardware is made from durable PVC.



Flip-open base discretely hides the pole and banner when not in use.



Lightweight aluminum base has a small footprint.

**MINI RETRACTORS**



These mini retractors can be used even when space is limited.

- Compact size
- Lightweight and portable
- Warranties range between six months and one year (see Retractable Banner Comparison Chart on page 27 for details)

**Economy Tabletop Retractor**

Item #	Description	1	2-5	6-11	12-24
261380	18" No-Curl Hybrid Media Kit	147.20	141.30	134.00	126.60
261381	18" No-Curl Opaque Fabric Kit	147.20	141.30	134.00	126.60
261382	18" PVC-Free Silver Backed Media Kit	147.20	141.30	134.00	126.60
261430	18" Dry-Erase Media Kit	147.20	141.30	134.00	126.60
261130	24" No-Curl Hybrid Media Kit	180.20	173.00	164.00	155.00
262160	24" No-Curl Opaque Fabric Kit	180.20	173.00	164.00	155.00
261360	24" PVC-Free Silver Backed Media Kit	180.20	173.00	164.00	155.00
261431	24" Dry-Erase Media Kit	180.20	173.00	164.00	155.00

**Setup fee: \$20(G)** Pricing is subject to change.  
Kit Includes: Silver or Black Hardware, Installed Graphic and Soft Carry Case USD MSRP (C)

Description	Product Size	Finished Graphic Size	Product Wt.	Media
deluxe mini	9.375"W x 17.75"H x 4"D	view online template	1.5 lbs.	Titan™ polypropylene media
small mini	9.625"W x 13.25"H x 3"D	view online template	1 lb.	Titan™ polypropylene media
large mini	13.125"W x 17.875"H x 3"D	view online template	1 lb.	Titan™ polypropylene media
18" economy	19"W x 28"H x 11"D	view online template	5.4 lbs.	see kit description
24" economy	24.75"W x 39"H x 11"D	view online template	5.5 lbs.	see kit description
liteway	24.75"W x 39"H x 11"D	view online template	5.8 lbs.	Titan™ no-curl hybrid media

**LiteWay Economy Tabletop Retractor**

Item #	Description	1	2-5	6-11	12-24
261434	Kit	120.00	112.80	108.00	100.80

**Setup fee: \$20(G)** Pricing is subject to change.  
Kit Includes: Black Hardware, Installed Graphic and Soft Carry Case USD MSRP (C)

**Mini Promo Retractor**

Item #	Description	1	2-5	6-11	12-24
210240	Small Kit	65.00	62.40	59.80	57.20
210242	Large Kit	72.65	69.75	66.85	63.95

**Setup fee: \$20(G)** Pricing is subject to change.  
Kit Includes: Hardware and Installed Graphic USD MSRP (C)

**Deluxe Mini Retractor**

Item #	Description	1	2-5	6-11	12-24
262014	Kit	83.95	80.60	77.20	73.85

**Setup fee: \$20(G)** Pricing is subject to change.  
Kit Includes: Hardware and Installed Graphic USD MSRP (C)

**Dry-Erase Media**

Dry-erase media, available for the Economy Tabletop Retractor, is both fun and functional. It features a glossy surface that has the write-on/wipe-off utility of a dry-erase board (dry-erase markers not included).

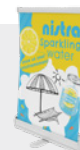



1

2

3

# BANNER DISPLAYS

1. EuroFit Angle Banner Display page 53 2. EuroFit Banner Display page 45 3. Tri-X Banner Display page 48

## have you considered...

- **location** where will your product be displayed?
- **message** do you want a single- or double-sided display?
- **transport** will your display be stationary or will it be moved from place to place?
- **longevity** how long will your message be displayed?

## how to **DISPLAY**

Use these powerful marketing tools to promote your business, products or services. They can be used at trade shows, conferences and exhibitions to communicate key messages, attract attention, and showcase offerings.



## EUROFIT BANNER DISPLAY



A fabric graphic cover slides over a tubed frame, letting you create amazing backdrops or portable privacy walls.

- Multiple sizes can be arranged together for endless display possibilities
- Artwork is dye sublimated on recycled polyester knit
- Double-sided graphic cover is viewable from both the front and back of the display
- Steel base with a black, powder-coated finish
- Not compatible with EuroFit Connector or EuroFit Cascade Merchandiser kits

### EuroFit Banner Display

Item #	Description	1	2-5	6-11	12-24
255110	2' Kit	317.00	307.50	298.00	288.50
255113	3' Kit	435.00	422.00	409.00	396.00
255116	4' Kit	581.00	563.50	546.00	528.50
255119	5' Kit	653.50	634.00	614.00	594.50

Setup fee: \$20(G)

Pricing is subject to change.

Kit Includes: Hardware, Graphic Cover and Soft Carry Case

USD MSRP (C)

Description	Product Size	Finished Graphic Size	Product Wt.	Media
2'	25.75"W x 91"H x 10"D	view online template	15.5 lbs.	recycled polyester knit
3'	37.75"W x 91"H x 10"D	view online template	20.5 lbs.	recycled polyester knit
4'	49"W x 91"H x 10"D	view online template	25.5 lbs.	recycled polyester knit
5'	61"W x 91"H x 10"D	view online template	31.5 lbs.	recycled polyester knit

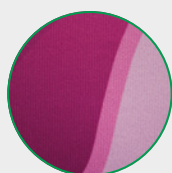

### Recycled Polyester Knit

This 100% recycled media is made with fibers recycled from plastic bottles. Recycled bottles are collected worldwide, cleaned and flaked, and made into resin that can be made into fibers.



Graphic cover slides easily over the frame for quick setup.

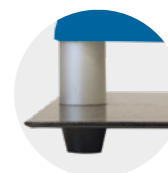

Plastic feet elevate the base and keep the display stable.

**PRICES ARE SUBJECT TO CHANGE.** No setup fee on orders placed via our website. Visit [showdowndisplays.com](http://showdowndisplays.com) for current pricing, graphic templates, product videos and assembly instructions. See pages 288-291 for order details. SHOWDOWNDISPLAYS.COM · ASI 87188 · PPAI 254687 · SAGE 67383 · PPPC 20101202

production lead time after final proof approval  
**4 DAYS**

# FRAMEWORX BANNER DISPLAY



These lightweight displays feature a contemporary design that brings new life to your exhibit.

- Banners attach using low-profile clear grommets
- 3' and 3.5' frames available in black or silver
- 4.5', 8.5' and 10.5' frames available in black only



Each tension spring features a double-sided hook so you can hang one banner or two.

## 3' FrameWorx Banner Display

Item #	Description	1	2-5	6-11	12-24
263061	13 oz. Smooth Scrim Vinyl Single-Sided Kit	204.20	196.00	187.80	179.70
263062	13 oz. Smooth Scrim Vinyl Double-Sided Kit	243.30	233.60	223.90	214.10
263065	No-Curl Opaque Fabric Kit	259.00	248.50	238.20	227.80

**Setup fee: \$20(G)** **Pricing is subject to change.**  
 Kit Includes: Silver or Black Hardware, Graphic and Soft Carry Case USD MSRP (C)

**Product Size** 36.75"W x 74"H x 15.5"D  
**Finished Graphic Size** view online template  
**Product Wt.** 5.6 lbs.

## 3.5' FrameWorx Banner Display

Item #	Description	1	2-5	6-11	12-24
263070	13 oz. Smooth Scrim Vinyl Single-Sided Kit	228.50	219.40	210.20	201.10
263071	13 oz. Smooth Scrim Vinyl Double-Sided Kit	267.50	256.75	246.10	235.40
263074	No-Curl Opaque Fabric Kit	276.75	265.75	254.75	243.60

**Setup fee: \$20(G)** **Pricing is subject to change.**  
 Kit Includes: Silver or Black Hardware, Graphic and Soft Carry Case USD MSRP (C)

**Product Size** 41"W x 81.75"H x 15.5"D  
**Finished Graphic Size** view online template  
**Product Wt.** 6.2 lbs.

## 4.5' FrameWorx Banner Display

Item #	Description	1	2-5	6-11	12-24
263314	13 oz. Smooth Scrim Vinyl Single-Sided Kit	281.25	270.00	258.75	247.60
263315	13 oz. Smooth Scrim Vinyl Double-Sided Kit	320.25	307.50	294.75	282.00
263317	No-Curl Opaque Fabric Kit	328.25	315.25	302.00	289.00

**Setup fee: \$20(G)** **Pricing is subject to change.**  
 Kit Includes: Black Hardware, Graphic and Soft Carry Case USD MSRP (C)

**Product Size** 54.75"W x 90.25"H x 15.5"D  
**Finished Graphic Size** view online template  
**Product Wt.** 10.5 lbs.

## 8.5' FrameWorx Banner Display

Item #	Description	1	2-5	6-11	12-24
263328	600 Denier Polyester Kit	540.00	518.50	497.00	475.25

**Setup fee: \$20(G)** **Pricing is subject to change.**  
 Kit Includes: Black Hardware, Graphic and Soft Carry Case USD MSRP (C)

**Product Size** 101.75"W x 90.5"H x 15.5"D  
**Finished Graphic Size** view online template  
**Product Wt.** 15 lbs.

## 10.5' FrameWorx Banner Display

Item #	Description	1	2-5	6-11	12-24
263331	600 Denier Polyester Kit	590.00	566.50	543.00	519.50

**Setup fee: \$20(G)** **Pricing is subject to change.**  
 Kit Includes: Black Hardware, Graphic and Soft Carry Case USD MSRP (C)

**Product Size** 123.25"W x 90.25"H x 15.5"D  
**Finished Graphic Size** view online template  
**Product Wt.** 17 lbs.



Fold-out feet for a small, but stable footprint.



Tension springs keep the banner centered and taut.

VINYL & NO-CURL DENIER production lead time after final proof approval  
**24 DAYS**

**PRICES ARE SUBJECT TO CHANGE.** No setup fee on orders placed via our website. Visit [showdowndisplays.com](http://showdowndisplays.com) for current pricing, graphic templates, product videos and assembly instructions. See pages 288-291 for order details.

SHOWDOWNDISPLAYS.COM · ASI 87188 · PPAI 254687 · SAGE 67383 · PPPC 20101202

# FRAMEWORX FACE CUTOUT BANNER DISPLAY



Let your guests become part of the show with this creative spin on our traditional FrameWorx display.

- Banners attach using low-profile clear grommets
- 3.5' frame available in black or silver
- 4.5' and 8.5' frames available in black only
- Face cutout hole locations are standard and cannot be customized



Face cutouts in 600 denier polyester are reinforced with black Lycra® binding, giving each cutout a black outline.



## 3.5' FrameWorx Face Cutout Banner Display

Item #	Description	1	2-5	6-11	12-24
263054	13 oz. Smooth Scrim Vinyl Single Kit	228.50	219.40	210.20	201.10
263055	13 oz. Smooth Scrim Vinyl Double Kit	228.50	219.40	210.20	201.10
263056	13 oz. Smooth Scrim Vinyl Junior Kit	228.50	219.40	210.20	201.10

**Setup fee: \$20(G)** Pricing is subject to change.  
Kit Includes: Silver or Black Hardware, Graphic and Soft Carry Case USD MSRP (C)

**Product Size** 41"W x 81.75"H x 15.5"D  
**Finished Graphic Size** view online template  
**Product Wt.** 6.2 lbs.

## 4.5' FrameWorx Face Cutout Banner Display

Item #	Description	1	2-5	6-11	12-24
263057	13 oz. Smooth Scrim Vinyl Double Kit	281.25	270.00	258.75	247.60

**Setup fee: \$20(G)** Pricing is subject to change.  
Kit Includes: Black Hardware, Graphic and Soft Carry Case USD MSRP (C)

**Product Size** 54.75"W x 90.25"H x 15.5"D  
**Finished Graphic Size** view online template  
**Product Wt.** 10.5 lbs.

## 8.5' FrameWorx Face Cutout Banner Display

Item #	Description	1	2-5	6-11	12-24
263334	600 Denier Polyester Quad Kit	561.00	538.50	516.00	493.75

**Setup fee: \$20(G)** Pricing is subject to change.  
Kit Includes: Black Hardware, Graphic and Soft Carry Case USD MSRP (C)

**Product Size** 101.75"W x 90.5"H x 15.5"D  
**Finished Graphic Size** view online template  
**Product Wt.** 15 lbs.



Face cutouts in vinyl do not have an outline.



Tension springs keep the banner centered and taut.

**PRICES ARE SUBJECT TO CHANGE.** No setup fee on orders placed via our website. Visit [showdowndisplays.com](http://showdowndisplays.com) for current pricing, graphic templates, product videos and assembly instructions. See pages 288-291 for order details. SHOWDOWNDISPLAYS.COM · ASI 87188 · PPAI 254687 · SAGE 67383 · PPPC 20101202

VINYL DENIER production lead time after final proof approval  
**24 DAYS**

# X BANNER DISPLAYS



The clean X design of these displays makes them simple, durable and easy to assemble.

- Artwork is printed on Titan™ 13 oz. smooth scrim vinyl
- The X shape of the frame is designed to keep the banner taut
- Corner grommets attach to plastic hooks on display arms
- Banners are finished with brass grommets by default; can be customized with nickel or clear plastic grommets by request
- Warranty details available online



Taurus



Lightweight plastic hub offers push-button arm adjustment.



Euro-X



Aluminum hub extends into the strong support leg.



Tri-X



Back leg attaches to the aluminum hub to stabilize the display.

## Euro-X Banner Display

Item #	Description	1	2-5	6-11	12-24
263123	23.5" x 70" Kit	223.80	214.80	205.90	196.90
263120	31.5" x 70" Kit	279.75	268.50	257.25	246.10
263126	31.5" x 79" Kit	293.50	281.75	270.00	258.25

Setup fee: \$20(G)

Pricing is subject to change.

Kit Includes: Hardware, Graphic and Drawstring Case

USD MSRP (C)

Description	Product Size	Finished Graphic Size	Product Wt.	Media
23.5" x 70"	23.5"W x 70"H x 23"D	view online template	2.75 lbs.	Titan™ 13 oz. smooth scrim vinyl
31.5" x 70"	31.5"W x 70"H x 20.5"D	view online template	3.25 lbs.	Titan™ 13 oz. smooth scrim vinyl
31.5" x 79"	31.5"W x 79"H x 20.5"D	view online template	3.5 lbs.	Titan™ 13 oz. smooth scrim vinyl

## Tri-X Banner Display

Item #	Description	1	2-5	6-11	12-24
263109	23.5" x 60" Kit	130.00	124.80	119.60	114.40
263106	23.5" x 70" Kit	144.00	138.20	132.50	126.70
263103	31.5" x 70" Kit	177.70	170.50	163.40	156.30
263112	31.5" x 79" Kit	204.10	195.90	187.80	179.60
263100	33.5" x 80" Kit	208.30	200.00	191.70	183.30

Setup fee: \$20(G)

Pricing is subject to change.

Kit Includes: Hardware, Graphic and Drawstring Case

USD MSRP (C)

Description	Product Size	Finished Graphic Size	Product Wt.	Media
23.5" x 60"	23.5"W x 60"H x 32.5"D	view online template	2 lbs.	Titan™ 13 oz. smooth scrim vinyl
23.5" x 70"	23.5"W x 70"H x 33.5"D	view online template	2.25 lbs.	Titan™ 13 oz. smooth scrim vinyl
31.5" x 70"	31.5"W x 70"H x 31.5"D	view online template	2.25 lbs.	Titan™ 13 oz. smooth scrim vinyl
31.5" x 79"	31.5"W x 79"H x 32.5"D	view online template	3 lbs.	Titan™ 13 oz. smooth scrim vinyl
33.5" x 80"	33.5"W x 80"H x 32.5"D	view online template	3.25 lbs.	Titan™ 13 oz. smooth scrim vinyl

## Taurus Banner Display

Item #	Description	1	2-5	6-11	12-24
210124	Kit	254.50	244.20	234.10	223.90

Setup fee: \$20(G)

Pricing is subject to change.

Kit Includes: Hardware, Graphic and Soft Carry Case

USD MSRP (C)

Product Size	Finished Graphic Size	Product Wt.	Media
40"W x 75"H x 14"D	view online template	5.25 lbs.	Titan™ 13 oz. smooth scrim vinyl



Mini X Banner Display is perfect for small areas. See page 257.

production lead time after final proof approval

**2 DAYS**

**PRICES ARE SUBJECT TO CHANGE.** No setup fee on orders placed via our website. Visit [showdowndisplays.com](http://showdowndisplays.com) for current pricing, graphic templates, product videos and assembly instructions. See pages 288-291 for order details.

SHOWDOWNDISPLAYS.COM · ASI 87188 · PPAI 254687 · SAGE 67383 · PPPC 20101202



## EVERYDAY BANNER DISPLAY



These displays feature a durable steel frame with a long-lasting, powder-coated finish.

- The Everyday Banner Display features pole pockets and dowels to hold the banner in place
- The Everyday Heavy-Duty Banner Display has all the same features as the Everyday Banner Display, but reinforced with a stronger, thicker frame and wider base
- The Everyday Snap Rail Banner Display replaces the dowels and pole pockets with snap rails for a clean finish
- Graphics are printed single-sided; double-sided kit includes two graphics
- Hex wrench included

### Everyday Banner Display

Item #	Description	1	2-5	6-11	12-24
210265	Everyday Single-Sided Kit	258.75	248.40	238.10	227.70
264020	Everyday Double-Sided Kit	355.00	340.75	326.50	312.25
210226	Everyday Heavy-Duty Single-Sided Kit	306.00	293.75	281.50	269.25
264021	Everyday Heavy-Duty Double-Sided Kit	402.75	386.75	370.50	354.50
190161	72"H x 24"W Banner Only*	104.90	100.70	96.50	92.30

Setup fee: \$20(G)

Pricing is subject to change.

Single-Sided Kit Includes: Hardware, 1 Graphic and 2 - 24" Dowels  
 Double-Sided Kit Includes: Hardware, 2 Graphics and 4 - 24" Dowels  
 \*Dowels not included in banner only orders

USD MSRP (C)

Description	Product Size	Finished Graphic Size	Product Wt. (Single / Double)	Media
everyday	24"W x 48"-92"H x 13"D	view online template	11 lbs. / 12.25 lbs.	Titan™ 11 mil polyester
heavy-duty	24"W x 55"-105"H x 14"D	view online template	13.5 lbs. / 14.5 lbs.	Titan™ 11 mil polyester

### Everyday Snap Rail Banner Display

Item #	Description	1	2-5	6-11	12-24
264030	24" Single-Sided Kit	286.75	275.25	263.75	252.25
264022	24" Double-Sided Kit	383.00	367.75	352.50	337.00
264032	30" Single-Sided Kit	300.75	288.75	276.75	264.75
264023	30" Double-Sided Kit	408.75	392.50	376.25	359.75
190310	24" Banner Only	104.90	100.70	96.50	92.30
190311	30" Banner Only	117.60	112.80	108.10	103.40

Setup fee: \$20(G)

Pricing is subject to change.

24" Kit Includes: Hardware and Single-Sided Graphic(s)  
 30" Kit Includes: Hardware and Single-Sided Graphic(s)  
 Hardware includes 4 snap rails for single- or double-sided use

USD MSRP (C)

Description	Product Size	Finished Graphic Size	Product Wt. (Single / Double)	Media
24"	24"W x 48"-92"H x 13.25"D	view online template	13 lbs. / 14 lbs.	Titan™ 11 mil polyester
30"	30"W x 48"-92"H x 13.25"D	view online template	14 lbs. / 16 lbs.	Titan™ 11 mil polyester

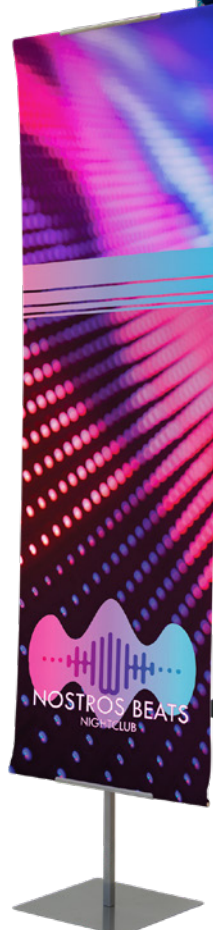

24" Everyday Snap Rail single-sided kit

Everyday Heavy-Duty double-sided kit

Everyday single-sided kit



Everyday hardware available in silver or black. Heavy-Duty and Snap Rail hardware available in black.



Telescoping pole with thumbscrew lets you adjust the hardware for custom banner heights (call for quote; restrictions may apply).



Each display can hold one or two banners.



Snap Rail kit offers easy banner installation: just slide the banner into the snap rails and clamp shut.

**PRICES ARE SUBJECT TO CHANGE.** No setup fee on orders placed via our website. Visit [showdowndisplays.com](http://showdowndisplays.com) for current pricing, graphic templates, product videos and assembly instructions. See pages 288-291 for order details.

SHOWDOWNDISPLAYS.COM · ASI 87188 · PPAI 254687 · SAGE 67383 · PPPC 20101202

production lead time after final proof approval  
**2DAYS**



Frame slides together and is held in place by hex set screws.



Includes two graphic panels for a double-sided display.



With a quick press of your thumb, the fabric's gasket edges are pushed into narrow channels built into the frame.

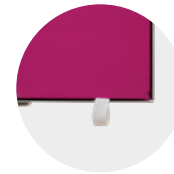

Pull tab lets you quickly remove SEG panel from the frame.

## EVERYDAY IMPRESS DISPLAY



Silicone Edge Graphics (SEG) give this display an upscale look that's sure to impress.

- Heavy-duty aluminum frame
- Artwork is dye sublimated on recycled polyester knit
- 100% recycled media is made with fibers recycled from plastic bottles
- Two hex wrenches and one open-end wrench included

### Everyday Impress Display

Item #	Description	1	2-5	6-11	12-24
210510	Kit	495.50	475.75	456.00	436.25

Setup fee: \$20(G)

Pricing is subject to change.

Kit Includes: Hardware and 2 Graphic Panels

USD MSRP (C)

Product Size	Finished Graphic Size	Product Wt.	Media
23.625"W x 73.125"H x 15.75"D	view online template	23 lbs.	recycled polyester knit

## FLEX BANNER DISPLAY



This display's versatile central post can be customized with banners and lit racks. We've created three kits to get started, but add-ons are interchangeable so you can create your own configuration.

- Artwork is dye sublimated on recycled polyester knit
- 100% recycled media is made with fibers recycled from plastic bottles
- Banners are double-sided
- Sturdy aluminum central post and banner rails
- Weighted steel base for stability

### Flex Banner Display

Item #	Description	1	2-5	6-11	12-24
263240	Single-Banner Kit	517.50	496.75	476.00	455.25
263245	Single-Banner with Lit Racks Kit	664.50	638.00	611.00	584.50
263243	Double-Banner Kit	712.50	684.00	655.50	627.00
263247	Banner and Rails Add-On	227.10	218.00	208.90	199.80
263248	Lit Rack Add-On (Set of 3)	156.70	150.40	144.10	137.90

Setup fee: \$20(G)

Pricing is subject to change.

Kits Includes: Hardware and Double-Sided Graphic(s)

USD MSRP (C)

Description	Product Size	Finished Graphic Size	Product Wt.	Media
single	27"W x 74"H x 14.75"D	view online template	24 lbs.	recycled polyester knit
single w/ lit racks	36"W x 74"H x 14.75"D	view online template	31 lbs.	recycled polyester knit
double	51.5"W x 74"H x 14.75"D	view online template	26.25 lbs.	recycled polyester knit



Double-banner

Single-banner with lit racks

Single-banner



Segmented post pieces fit together and must be secured in place with the included hex wrench.



Banner rails slide into a groove on the central post and can be adjusted for custom banner heights (call for quote; restrictions may apply).

production lead time after final proof approval

**4 DAYS**

**PRICES ARE SUBJECT TO CHANGE.** No setup fee on orders placed via our website.

Visit [showdowndisplays.com](http://showdowndisplays.com) for current pricing, graphic templates, product videos and assembly instructions. See pages 288-291 for order details.

SHOWDOWNDISPLAYS.COM · ASI 87188 · PPAI 254687 · SAGE 67383 · PPPC 20101202



## ESSENTIAL BANNER DISPLAY



Stick to the essentials. This banner display combines classic form and function to make your message stand out.

- Lightweight and simple
- Tripod-style legs and telescoping pole for fast and easy setup
- Banners attach quickly using snap rails
- Artwork is printed on Titan™ no-curl fabric
- Includes two single-sided banners for a double-sided display
- Telescoping pole is compatible with custom banner heights (call for quote; restrictions may apply)

### Essential Banner Display

Item #	Description	1	2-5	6-11	12-24
263410	Kit	250.00	240.00	230.00	220.00

**Setup fee: \$20(G)** **Pricing is subject to change.**  
 Kit Includes: Hardware, 2 Single-Sided Graphics and Soft Carry Case USD MSRP (C)

Product Size	Finished Graphic Size	Product Wt.	Media
28.625"W x 65"-89"H x 28.625"D	<a href="#">view online template</a>	6 lbs.	Titan™ no-curl fabric

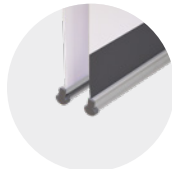

Simply slide the banner into the snap rails and clamp shut.



Tripod-style legs provide stability.



Flip-lever telescoping pole makes setup and adjustment simple.



Hardware folds together in one piece for easy transportation.

**PRICES ARE SUBJECT TO CHANGE.** No setup fee on orders placed via our website. Visit [showdowndisplays.com](http://showdowndisplays.com) for current pricing, graphic templates, product videos and assembly instructions. See pages 288-291 for order details. SHOWDOWNDISPLAYS.COM · ASI 87188 · PPAI 254687 · SAGE 67383 · PPPC 20101202

production lead time after final proof approval  
**3 DAYS**



### EUROFIT ROUND BANNER DISPLAY



Round up your display with this impressively-shaped extension to our EuroFit Banner display product line.

- Artwork is dye sublimated on recycled polyester knit
- 100% recycled media is made with fibers recycled from plastic bottles
- Available in two sizes
- 36" includes an additional bottom wrap graphic to increase ad space
- Double-sided graphic cover is viewable from both the front and back of the display
- Not compatible with EuroFit Connector or EuroFit Cascade Merchandiser kits

#### EuroFit Round Banner Display

Item #	Description	1	2-5	6-11	12-24
256540	36" Kit	454.50	436.25	418.25	400.00
256546	60" Kit	594.00	570.50	546.50	523.00

**Setup fee: \$20(G)**

**Pricing is subject to change.**

36" Kit Includes: Hardware, 2 Graphic Covers and Soft Carry Case  
 60" Kit Includes: Hardware, Graphic Cover and Soft Carry Case

USD MSRP (C)

Description	Product Size	Finished Graphic Size	Product Wt.	Media
36"	36"W x 78"H x 9.875"D	view online template	13.4 lbs.	recycled polyester knit
60"	60"W x 77.25"H x 9.875"D	view online template	18 lbs.	recycled polyester knit



Bottom graphic wrap for the 36" kit slips over the frame to maximize your message area.



Double-sided graphic cover slips over the frame like a pillowcase, then zips shut on the top.

production lead time after final proof approval

**4 DAYS**

**PRICES ARE SUBJECT TO CHANGE.** No setup fee on orders placed via our website.

Visit [showdowndisplays.com](http://showdowndisplays.com) for current pricing, graphic templates, product videos and assembly instructions. See pages 288-291 for order details.

SHOWDOWNDISPLAYS.COM · ASI 87188 · PPAI 254687 · SAGE 67383 · PPPC 20101202

## EUROFIT ANGLE BANNER DISPLAY



Stand out from other displays with this unique angular shape!

- Lightweight aluminum frame
- Available in two sizes
- Artwork is dye sublimated on recycled polyester knit
- 100% recycled media is made with fibers recycled from plastic bottles
- Double-sided graphic cover is viewable from both the front and back of the display
- Not compatible with EuroFit Connector or EuroFit Cascade Merchandiser kits

### EuroFit Angle Banner Display

Item #	Description	1	2-5	6-11	12-24
256550	80"H Kit	367.75	356.50	345.50	334.50
256553	100"H Kit	420.25	407.50	395.00	382.25

Setup fee: \$20(G)

Pricing is subject to change.

Kit Includes: Hardware, Graphic Cover and 2 Soft Carry Cases

USD MSRP (C)

Description	Product Size	Finished Graphic Size	Product Wt.	Media
80"H	35.75"W x 79.625"H x 16.5"D	view online template	13.5 lbs.	recycled polyester knit
100"H	49"W x 100.5"H x 19.625"D	view online template	19 lbs.	recycled polyester knit



100"H

80"H



Easily transport your display with the included soft carry cases.



Sturdy steel base provides stability.

**PRICES ARE SUBJECT TO CHANGE.** No setup fee on orders placed via our website. Visit [showdownndisplays.com](http://showdownndisplays.com) for current pricing, graphic templates, product videos and assembly instructions. See pages 288-291 for order details. SHOWDOWNNDISPLAYS.COM · ASI 87188 · PPAI 254687 · SAGE 67383 · PPPC 20101202

production lead time after final proof approval  
**4 DAYS**



## EUROFIT PRO HANGING BANNER



This hanging banner offers convenient overhead message space in dimensions ideal for retail environments.

- Lightweight aluminum frame
- Artwork is dye sublimated on recycled polyester knit
- 100% recycled media is made with fibers recycled from plastic bottles
- Joints are labeled for step-by-step frame assembly
- Zippered graphic cover is taut and wrinkle-free when installed
- Hanging cables not included (most convention centers will require you to use their designated hanging hardware)

### EuroFit Pro Hanging Banner

Item #	Description	1	2-5	6-11	12-24
210282	4' x 12" Round Double-Sided Kit	869.50	835.00	800.00	765.50
210283	4' x 12" Round Bottom Panel Kit	939.50	902.00	864.50	827.00
210287	6' x 20" Round Double-Sided Kit	1043.00	1001.00	959.50	918.00
210288	6' x 20" Round Bottom Panel Kit	1120.00	1075.00	1030.00	985.50

**Setup fee: \$20(G)**

**Pricing is subject to change.**

Kit Includes: Frame, Graphic Cover and Soft Carry Case

USD MSRP (C)

Description	Product Size	Finished Graphic Size	Product Wt. (Double / Bottom)	Media
4'	12.5"H x 48"D	view online template	10.5 lbs. / 11 lbs.	recycled polyester knit
6'	20.25"H x 72"D	view online template	18.5 lbs. / 19.75 lbs.	recycled polyester knit

### Kit Options



#### Double-Sided Kit

Artwork is printed on both the inside and the outside of the graphic cover.



#### Bottom Panel Kit

Artwork is printed on the outside of the graphic cover, and the bottom is sealed off with an additional printed panel so the inside remains hidden.



## EUROFIT HANGING BANNER



Grab attention from a distance with this three-dimensional hanging banner.

- Lightweight aluminum frame
- Artwork is dye sublimated on recycled polyester knit
- 100% recycled media is made with fibers recycled from plastic bottles
- Zippered graphic cover is taut and wrinkle-free when installed
- Hanging cables not included (most convention centers will require you to use their designated hanging hardware)

### EuroFit Hanging Banner

Item #	Description	1	2-5	6-11	12-24
210150	6' x 36" Round Single-Sided Kit	1440.00	1382.00	1325.00	1267.00
210154	8' x 42" Round Single-Sided Kit	1915.00	1839.00	1762.00	1686.00
210158	10' x 48" Round Single-Sided Kit	2398.00	2302.00	2206.00	2110.00
210162	12' x 48" Round Single-Sided Kit	2762.00	2651.00	2541.00	2431.00
210227	8' x 42" Square Single-Sided Kit	2041.00	1959.00	1878.00	1796.00
210229	8' x 42" Triangle Single-Sided Kit	1678.00	1611.00	1543.00	1476.00

**Setup fee: \$20(G)**

**Pricing is subject to change.**

Kit Includes: Frame, Graphic Cover and Soft Carry Case

USD MSRP (C)

Description	Product Size	Finished Graphic Size	Product Wt.	Media
6' round	36"H x 72"D	view online template	13.25 lbs.	recycled polyester knit
8' round	42.13"H x 96"D	view online template	17.5 lbs.	recycled polyester knit
10' round	48"H x 120"D	view online template	25.75 lbs.	recycled polyester knit
12' round	48"H x 144"D	view online template	32.5 lbs.	recycled polyester knit
8' square	96"W x 42"H x 96"D	view online template	20 lbs.	recycled polyester knit
8' triangle	96"W x 42"H x 96"D	view online template	17 lbs.	recycled polyester knit

production lead time  
after final proof approval

**4 DAYS**

**PRICES ARE SUBJECT TO CHANGE.** No setup fee on orders placed via our website.

Visit [showdowndisplays.com](http://showdowndisplays.com) for current pricing, graphic templates, product videos and assembly instructions. See pages 288-291 for order details.

SHOWDOWNDISPLAYS.COM · ASI 87188 · PPAI 254687 · SAGE 67383 · PPPC 20101202

## HEADLINER BANNER DISPLAY



This enormous banner display is great for use in parking lots or at outdoor events.

- Banner available in backlit woven polyester or Titan™ 18 oz. opaque scrim vinyl; face cutout available in vinyl only
- Includes four heavy-duty black stakes
- Adjustable frame hardware is compatible with custom banner heights and widths (call for quote; restrictions may apply)
- Face cutout hole locations are standard and cannot be customized
- Banners used outdoors have a 90-day warranty; banners used indoors have a 1-year warranty



Thumbscrews on the frame make it easy to set up and adjust.

Headliner Face Cutout

Headliner



Heavy-duty steel foot features a handle so it's easy to position during setup.

### Headliner Banner Display

Item #	Description	1	2-5	6-11	12-24
263400	Backlit Woven Polyester Single-Sided Kit	1749.00	1679.00	1609.00	1539.00
263401	18 oz. Opaque Scrim Vinyl Single-Sided Kit	1749.00	1679.00	1609.00	1539.00
263402	18 oz. Opaque Scrim Vinyl Double-Sided Kit	1888.00	1812.00	1737.00	1661.00
263272	18 oz. Opaque Scrim Vinyl Quad Face Cutout Kit	1749.00	1679.00	1609.00	1539.00

Setup fee: \$20(G)

Pricing is subject to change.

Kit Includes: Hardware, Graphic, 4 Stakes and Soft Carry Case with Wheels

USD MSRP (C)

Description	Product Size	Finished Graphic Size	Product Wt. (Polyester / Vinyl)
headliner	129.75"W x 85.25"H x 39.5"D	view online template	56 lbs. / 60 lbs.
face cutout	129.75"W x 85.25"H x 39.5"D	view online template	NA / 60 lbs.



C-clips attach to clear grommets along the side of the banner to keep it secure.

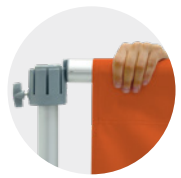

Banner rail slides into notches in the frame's hubs.

### Add-On

#### Square Plastic Ballast

Item #	Description	Product Wt.	1	2-5	6-11	12-24
263298	Ballast (Set of 2)	37.4 lbs. w/ water	87.20	83.70	80.20	76.75

Pricing is subject to change.

USD MSRP (C)

## OUTDOOR BALLAST DISPLAY



This attractive outdoor display has a smaller footprint and works well in tight spaces.

- Graphic panel provides plenty of space to display your message
- Artwork is dye sublimated on recycled polyester knit
- 100% recycled media is made with fibers recycled from plastic bottles
- Perfect for indoor or short-term outdoor use
- Graphic covers used outdoors have a 90-day warranty; graphic covers used indoors have a 1-year warranty

### Outdoor Ballast Display

Item #	Description	1	2-5	6-11	12-24
263420	Kit	692.00	636.50	595.00	553.50

Setup fee: \$20(G)

Pricing is subject to change.

Kit Includes: Hardware, Graphic Cover, 2 Ballasts and Soft Carry Case

USD MSRP (C)

Product Size	Finished Graphic Size	Product Wt.	Media
78"W x 59.75"H x 19.5"D	view online template	18.5 lbs.	recycled polyester knit

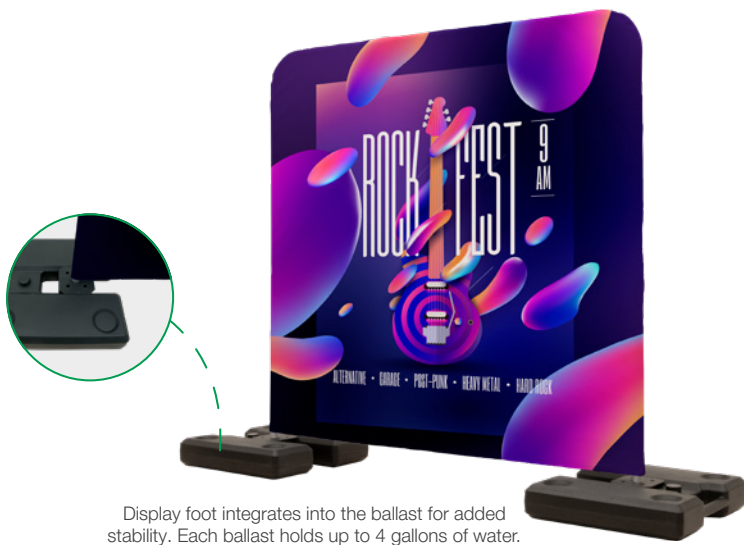

Display foot integrates into the ballast for added stability. Each ballast holds up to 4 gallons of water.

**HARDWARE-ONLY LEAD TIME: SHIPS SAME DAY WHEN ORDERED BEFORE 2 PM CENTRAL**  
**PRICES ARE SUBJECT TO CHANGE.** No setup fee on orders placed via our website.  
 Visit [showdowndisplays.com](http://showdowndisplays.com) for current pricing, graphic templates, product videos and assembly instructions. See pages 288-291 for order details.  
 SHOWDOWNDISPLAYS.COM · ASI 87188 · PPAI 254687 · SAGE 67383 · PPPC 20101202

VINYL POLYESTER & BALLAST production lead time after final proof approval  
**2-OR-4 DAYS**



# BANNERS & FLAGS

1. Premium Sail Sign pages 84-85 2. Vinyl Banner page 61 3. Fabric Flag pages 74-75 4. Streamline Sail Sign pages 82-83

## have you considered...

- **location** will you be using this product indoors or outdoors?
- **use** will you be hanging it on a wall, mounting it on a pole or do you need a standalone display?
- **longevity** how long will your banner or flag be displayed?
- **weather** are there extreme weather conditions to consider?
- **message** do you need a single- or double-sided banner or flag?

## how to **DISPLAY**

Banners and flags are designed to attract attention with vibrant colors and dynamic designs, making them easily noticeable from a distance. Available for indoor and outdoor use, they are a perfect marketing tool. Great for entry points, festivals, and other events.

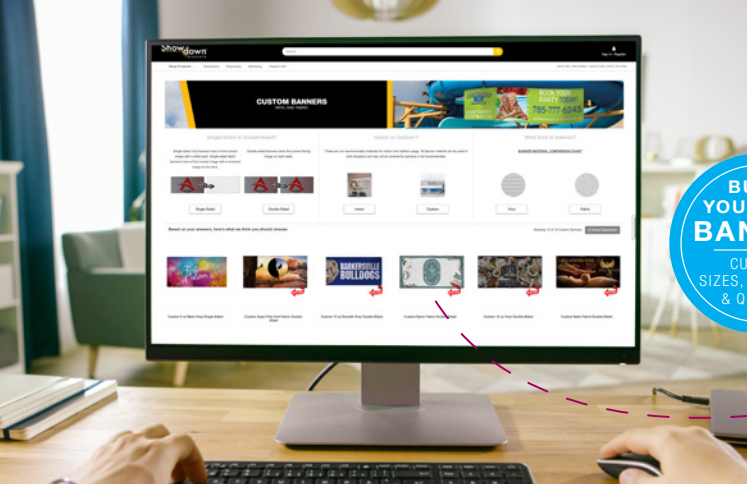

**BUILD YOUR OWN BANNER**  
CUSTOM SIZES, FINISHING & QUOTES

# BUILD YOUR OWN BANNERS

WITH OUR QUICK & EASY ONLINE TOOL

Visit our website for accurate quotes and hassle-free ordering 24/7!

Under the Banners & Flags tab, click **Build Your Own Banners**.  
Accurate Quoting · Large Quantities · Additional Finishing Styles · Custom Sizes

## BANNER MATERIAL COMPARISON CHART

BEST SELLERS ★ SUSTAINABLE ◆	DURABILITY			WIND RATING	INDOOR USE	OUTDOOR USE
	TITAN™ SCRIM VINYL	LIGHT	AVERAGE			
10 oz.	X			5	good	good
13 oz. ★		X		6	better	better
13 oz. Smooth		X		not for outdoor use	<b>BEST</b>	not for outdoor use
18 oz. Opaque ★			X	6	better	<b>BEST</b>
9 oz. Mesh ★			X	6	better	<b>BEST</b>
<b>PVC-FREE</b>	<b>LIGHT</b>	<b>AVERAGE</b>	<b>HEAVY-DUTY</b>			
9 oz. PVC-Free ◆		X		6	better	better
<b>FABRIC</b>	<b>LIGHT</b>	<b>AVERAGE</b>	<b>HEAVY-DUTY</b>			
Nylon		X		6	better	<b>BEST</b>
Polyester Poplin	X			not for outdoor use	<b>BEST</b>	not for outdoor use
Super Poly Knit		X		4	better	better
Satin	X			not for outdoor use	better	not for outdoor use

**Beaufort Wind Rating:** See rating icon underneath the product name. Wind ratings were determined utilizing all available securing/stabilizing options sold with or offered for the product. See page 291 for details.

### Popular Finishing Styles

Additional finishing styles available online.

#### Heat Weld

Single-sided vinyl banners only



Hem & Grommets



Hem, Rope & Grommets

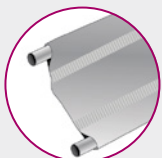

3" Pole Pockets

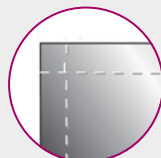

Hem Only



Hem & Grommets

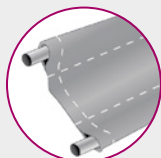

3" Pole Pockets

#### Sewn

Fabric and vinyl banners

### Banner Material



#### Scrim

Woven threads that provide added strength for a stronger vinyl banner.



#### Smooth

Vinyl without visible scrim texture for higher-quality images.

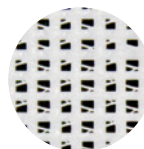

#### Mesh

A woven vinyl pattern that features small holes so wind can pass through.

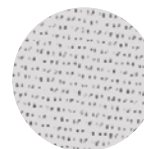

#### Fabric

Breathable, lightweight cloth.



## 9 OZ. MESH VINYL BANNER



This single-sided banner is made of breathable 60/40 mesh vinyl that excels on breezy days.

- Multiple finishing styles available (see page 57)
- Banners used outdoors have a 90-day warranty; banners used indoors have a 1-year warranty



3' x 6' banner with grommets

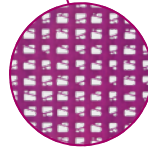

Breathable  
9 oz. mesh vinyl.

### 9 oz. Mesh Vinyl Banner

Item #	Description	Product Wt.	1	2-4	5-14	15-33
304411	2' x 6'	1.25 lbs.	64.40	59.10	54.20	50.20
Item #	Description	Product Wt.	1	2-3	4-9	10-22
304414	3' x 6'	2 lbs.	96.60	88.65	81.35	75.30
Item #	Description	Product Wt.	1-2	3-7	8-16	17-33
304415	3' x 8'	2.5 lbs.	118.60	108.40	100.40	90.60
Item #	Description	Product Wt.	1	2-5	6-13	14-26
304416	3' x 10'	3.25 lbs.	148.30	135.60	125.50	113.30
Item #	Description	Product Wt.	1	2-5	6-12	13-24
304417	4' x 8'	3 lbs.	158.10	144.60	133.80	120.80
Item #	Description	Product Wt.	1	2-4	5-9	10-19
304418	4' x 10'	4.25 lbs.	197.70	180.80	167.30	151.00

Setup fee: \$20(G)

Pricing is subject to change.

USD MSRP (C)



2' x 4' banner with grommets

## 9 OZ. PVC-FREE BANNER



PVC-free banners are an environmentally conscious solution that reduces the impact of PVC on our planet.

- A recyclable and eco-friendly alternative to vinyl banners
- Banners can be used indoors and outdoors
- Artwork is vibrantly printed on 100% PVC-free material
- Only available with sewn finishing style (see page 57)

### 9 oz. PVC-Free Banner

Item #	Description	Product Wt.	1-2	3-7	8-22	23-49
304970	2' x 4'	1 lb.	47.08	42.98	38.75	36.06
Item #	Description	Product Wt.	1	2-4	5-14	15-33
304971	2' x 6'	1.25 lbs.	70.65	64.50	58.15	54.10
Item #	Description	Product Wt.	1	2-3	4-9	10-22
304972	3' x 6'	2 lbs.	106.00	96.75	87.20	81.15
Item #	Description	Product Wt.	1-2	3-7	8-16	17-33
304973	3' x 8'	2.5 lbs.	129.10	116.30	108.20	96.80
Item #	Description	Product Wt.	1	2-5	6-13	14-26
304974	3' x 10'	3.25 lbs.	161.30	145.30	135.30	121.00
Item #	Description	Product Wt.	1	2-5	6-12	13-24
304975	4' x 8'	3 lbs.	172.00	155.00	144.20	129.00

Setup fee: \$20(G)

Pricing is subject to change.

USD MSRP (C)

VINYL PVC-FREE production lead time after final proof approval  
**24 DAYS**

**PRICES ARE SUBJECT TO CHANGE.** No setup fee on orders placed via our website. Visit [showdowndisplays.com](http://showdowndisplays.com) for current pricing, graphic templates, product videos and assembly instructions. See pages 288-291 for order details.

SHOWDOWNDISPLAYS.COM · ASI 87188 · PPAI 254687 · SAGE 67383 · PPPC 20101202

## 10 OZ. SCRIM VINYL BANNER



This single-sided, light-duty banner is perfect for indoor or short-term outdoor use.

- Multiple finishing styles available (see page 57)
- Banners used outdoors have a 90-day warranty; banners used indoors have a 1-year warranty

### 10 oz. Scrim Vinyl Banner

Item #	Description	Product Wt.	1-2	3-7	8-22	23-49
304245	2' x 4'	0.5 lb.	35.55	33.42	31.16	28.88
Item #	Description	Product Wt.	1	2-4	5-14	15-33
304247	2' x 6'	1 lb.	53.35	50.15	46.75	43.34
Item #	Description	Product Wt.	1	2-3	4-9	10-22
304252	3' x 6'	1.25 lbs.	79.95	75.15	70.10	64.95
Item #	Description	Product Wt.	1-2	3-7	8-16	17-33
304253	3' x 8'	2 lbs.	100.00	93.90	86.50	77.35
304255	4' x 6'	1.5 lbs.	100.00	93.90	86.50	77.35
Item #	Description	Product Wt.	1	2-5	6-12	13-24
304256	4' x 8'	2 lbs.	133.40	125.30	115.40	103.20

Setup fee: \$20(G)

Pricing is subject to change.

USD MSRP (C)



3' x 8' banner with rope and grommets

## 13 OZ. SCRIM VINYL BANNER



Versatile enough for both indoor and outdoor use, this single-sided banner is a top choice when it comes to value.

- Multiple finishing styles available (see page 57)
- Banners used outdoors have a 90-day warranty; banners used indoors have a 1-year warranty

### 13 oz. Scrim Vinyl Banner

Item #	Description	Product Wt.	1-2	3-7	8-22	23-49
304360	2' x 4'	1 lb.	37.67	33.90	30.51	27.88
Item #	Description	Product Wt.	1	2-4	5-14	15-33
304361	2' x 6'	2 lbs.	56.50	50.85	45.78	41.82
Item #	Description	Product Wt.	1	2-3	4-9	10-22
304364	3' x 6'	2.5 lbs.	84.75	76.25	68.65	62.70
Item #	Description	Product Wt.	1-2	3-7	8-16	17-33
304365	3' x 8'	3.25 lbs.	103.30	93.00	83.70	76.45
Item #	Description	Product Wt.	1	2-5	6-13	14-26
304366	3' x 10'	4 lbs.	129.20	116.30	104.60	95.60
Item #	Description	Product Wt.	1	2-5	6-12	13-24
304367	4' x 8'	4 lbs.	137.80	124.00	111.60	101.90

Setup fee: \$20(G)

Pricing is subject to change.

USD MSRP (C)



3' x 8' banner with grommets

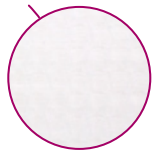

This smooth vinyl material is great for displaying high-quality print.

4' x 8' banner with grommets

### 13 OZ. SMOOTH SCRIM VINYL BANNER

Showcase high-quality print on the extra smooth surface of this indoor banner.

- Multiple finishing styles available (see page 57)
- Banners used indoors have a 1-year warranty

#### 13 oz. Smooth Scrim Vinyl Banner (Single-Sided)

Item #	Description	Product Wt.	1-2	3-7	8-22	23-49
304225	2' x 4'	1 lb.	41.65	37.49	33.88	31.65
Item #	Description	Product Wt.	1	2-3	4-9	10-22
304229	3' x 6'	2 lbs.	93.75	84.35	76.25	71.25
Item #	Description	Product Wt.	1-2	3-7	8-16	17-33
304230	3' x 8'	2.5 lbs.	113.10	101.70	94.70	85.90
304261	4' x 6'	2.5 lbs.	113.10	101.70	94.70	85.90
Item #	Description	Product Wt.	1	2-5	6-12	13-24
304232	4' x 8'	3.5 lbs.	150.70	135.60	126.00	114.50
Item #	Description	Product Wt.	1	2-4	5-9	10-19
304233	4' x 10'	4.25 lbs.	188.40	169.50	157.50	143.10

Setup fee: \$20(G)

Pricing is subject to change.

USD MSRP (C)



4' x 10' banner with grommets

#### 13 oz. Smooth Scrim Vinyl Banner (Double-Sided)

Item #	Description	Product Wt.	1-2	3-7	8-22	23-49
304460	2' x 4'	1 lb.	62.25	58.00	53.30	50.20
Item #	Description	Product Wt.	1	2-4	5-14	15-33
304461	2' x 6'	1.25 lbs.	93.45	87.05	80.00	75.35
Item #	Description	Product Wt.	1	2-3	4-9	10-22
304462	3' x 6'	2 lbs.	140.10	130.50	120.00	113.00
Item #	Description	Product Wt.	1-2	3-7	8-16	17-33
304463	3' x 8'	2.5 lbs.	173.80	159.50	146.40	135.50

Setup fee: \$20(G)

Pricing is subject to change.

USD MSRP (C)

production lead time after final proof approval

**2 DAYS**

**PRICES ARE SUBJECT TO CHANGE.** No setup fee on orders placed via our website.

Visit [showdowndisplays.com](http://showdowndisplays.com) for current pricing, graphic templates, product videos and assembly instructions. See pages 288-291 for order details.

SHOWDOWNDISPLAYS.COM · ASI 87188 · PPAI 254687 · SAGE 67383 · PPPC 20101202



### 18 OZ. OPAQUE SCRIM VINYL BANNER



This banner is reinforced with scrim, making it extremely durable for outdoor use.

- Multiple finishing styles available (see page 57)
- Banners used outdoors have a 90-day warranty; banners used indoors have a 1-year warranty

#### 18 oz. Opaque Scrim Vinyl Banner (Single-Sided)

Item #	Description	Product Wt.	1	2-4	5-14	15-33
304383	3' x 4'	2 lbs.	64.40	59.10	54.20	50.20
Item #	Description	Product Wt.	1	2-3	4-9	10-22
304384	3' x 6'	2.5 lbs.	96.60	88.65	81.35	75.30
Item #	Description	Product Wt.	1-2	3-7	8-16	17-33
304385	3' x 8'	3.25 lbs.	118.40	108.70	100.70	90.45
Item #	Description	Product Wt.	1	2-5	6-13	14-26
304386	3' x 10'	4 lbs.	148.00	135.90	125.80	113.00
Item #	Description	Product Wt.	1	2-5	6-12	13-24
304387	4' x 8'	4 lbs.	157.80	144.90	134.20	120.60
Item #	Description	Product Wt.	1	2-4	5-9	10-19
304388	4' x 10'	5 lbs.	197.30	181.20	167.80	150.70

Setup fee: \$20(G) Pricing is subject to change. USD MSRP (C)

#### 18 oz. Opaque Scrim Vinyl Banner (Double-Sided)

Item #	Description	Product Wt.	1-2	3-7	8-22	23-49
304470	2' x 4'	1 lb.	90.95	85.50	79.50	74.65
Item #	Description	Product Wt.	1	2-4	5-14	15-33
304471	2' x 6'	2 lbs.	136.40	128.20	119.20	112.00
Item #	Description	Product Wt.	1	2-3	4-9	10-22
304472	3' x 6'	2.5 lbs.	204.70	192.40	178.90	168.00
Item #	Description	Product Wt.	1-2	3-7	8-16	17-33
304473	3' x 8'	3.25 lbs.	256.00	238.10	223.70	206.80
Item #	Description	Product Wt.	1	2-5	6-12	13-24
304474	4' x 8'	4 lbs.	341.50	317.50	298.50	276.00

Setup fee: \$20(G) Pricing is subject to change. USD MSRP (C)



4' x 10' banner with grommets



2' x 4' banners with pole pockets

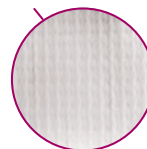

Scrim texture will be subtly visible on the backside of the banner.



5' x 8' banner with grommets

3' x 6' banner with grommets



2' x 4' banner with grommets

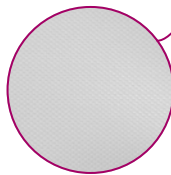

Fade-resistant 200 denier nylon.

### NYLON BANNER



This lightweight and fade-resistant banner is great for indoor or outdoor use.

- Multiple finishing styles available (see page 57)
- Banners used outdoors have a 90-day warranty; banners used indoors have a 1-year warranty
- Not eligible for Rush Service

#### Nylon Banner (Single-Sided)

Item #	Description	Product Wt.	1-2	3-7	8-22	23-49
304980	2' x 4'	0.4 lb.	77.50	73.65	68.20	65.10
304981	2' x 5'	0.5 lb.	96.90	92.05	85.25	81.40
304982	3' x 6'	0.7 lb.	174.40	165.70	153.50	146.50
304983	3' x 8'	0.8 lb.	207.60	197.20	182.70	174.40
304984	4' x 8'	0.9 lb.	276.75	263.00	243.60	232.50
304985	5' x 8'	1 lb.	346.00	328.75	304.50	290.75

Setup fee: \$20(G)

Pricing is subject to change.

USD MSRP (C)

#### Nylon Banner (Double-Sided)

Item #	Description	Product Wt.	1-2	3-7	8-22	23-49
304986	2' x 4'	1.2 lbs.	155.00	147.30	136.40	130.20
304987	2' x 5'	1.5 lbs.	193.80	184.10	170.50	162.80
304988	3' x 6'	2.1 lbs.	348.75	331.50	307.00	293.00
304989	3' x 8'	1.6 lbs.	415.25	394.50	365.50	348.75
304990	4' x 8'	1.8 lbs.	553.50	526.00	487.25	465.00
304991	5' x 8'	3 lbs.	692.00	657.50	609.00	581.50

Setup fee: \$20(G)

Pricing is subject to change.

USD MSRP (C)



production lead time after final proof approval

**4 DAYS**

**PRICES ARE SUBJECT TO CHANGE.** No setup fee on orders placed via our website.

Visit [showdowndisplays.com](http://showdowndisplays.com) for current pricing, graphic templates, product videos and assembly instructions. See pages 288-291 for order details.

SHOWDOWNDISPLAYS.COM · ASI 87188 · PPAI 254687 · SAGE 67383 · PPPC 20101202



End caps and rope connect to the top dowel.

## HANGING BANNER



Lightweight and pre-kitted for fast, professional branding for indoor events, lobbies or retail spaces.

- Artwork is dye sublimated on lightweight polyester knit
- Banner is single-sided
- Top and bottom hidden dowels ensure a smooth, professional display
- Includes black or white end caps and matching rope
- Heat-treated side edges for durability and a clean finish
- Custom lengths available (call for quote; restrictions may apply)

### Hanging Banner

Item #	Description	Product Wt.	1	2-5	6-11	12-24
303100	2' x 3' Kit	1.3 lbs.	60.00	57.60	55.20	52.80
303102	2' x 4' Kit	1.4 lbs.	65.00	62.40	59.80	57.20
303104	2' x 5' Kit	1.5 lbs.	70.00	67.20	64.40	61.60
303106	3' x 3' Kit	1.4 lbs.	75.00	72.00	69.00	66.00
303108	3' x 4' Kit	1.5 lbs.	80.00	76.80	73.60	70.40
303110	3' x 5' Kit	1.7 lbs.	85.00	81.60	78.20	74.80

**Setup fee: \$20(G)** **Pricing is subject to change.**  
 Kit Includes: Graphic with Installed Dowels, Black or White USD MSRP (C)  
 End Caps and Rope

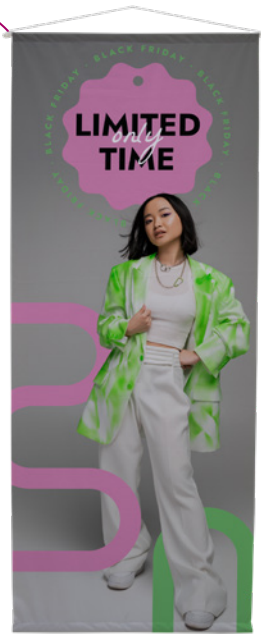

2' x 5' banner with white rope and end caps



3' x 4' banner with black rope and end caps



3' x 6' banner with grommets

2' x 4' banner with grommets

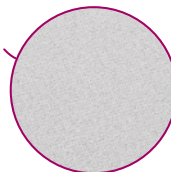

High-quality poly poplin fabric.

### POLY POPLIN FABRIC BANNER

With high-quality dye-sublimated graphics, this banner is ideal for indoor, close-range viewing.

- Multiple finishing styles available (see page 57)
- Banners used indoors have a 1-year warranty

#### Poly Poplin Fabric Banner

Item #	Description	Product Wt.	1-2	3-7	8-22	23-49
305000	2' x 4'	0.25 lb.	63.35	58.85	55.60	53.35
Item #	Description	Product Wt.	1	2-5	6-17	18-39
305012	2' x 5'	0.5 lb.	79.20	73.55	69.50	66.65
Item #	Description	Product Wt.	1	2-4	5-14	15-33
305001	2' x 6'	0.5 lb.	95.10	88.30	83.45	80.00
Item #	Description	Product Wt.	1	2-3	4-11	12-26
305002	2' x 8'	0.5 lb.	126.70	117.70	111.20	106.70
305014	3' x 5'	0.5 lb.	118.90	110.40	104.30	100.00
Item #	Description	Product Wt.	1	2-3	4-9	10-22
305004	3' x 6'	1 lb.	142.60	132.40	125.20	120.00
Item #	Description	Product Wt.	1-2	3-7	8-16	17-33
305005	3' x 8'	1 lb.	176.70	167.00	160.10	148.70
Item #	Description	Product Wt.	1	2-5	6-12	13-24
305007	4' x 8'	1 lb.	235.50	222.60	213.40	198.20

Setup fee: \$20(G)

Pricing is subject to change.

USD MSRP (C)

production lead time after final proof approval

**4 DAYS**

**PRICES ARE SUBJECT TO CHANGE.** No setup fee on orders placed via our website. Visit [showdowndisplays.com](http://showdowndisplays.com) for current pricing, graphic templates, product videos and assembly instructions. See pages 288-291 for order details.

SHOWDOWNDISPLAYS.COM · ASI 87188 · PPAI 254687 · SAGE 67383 · PPPC 20101202

## SUPER POLY KNIT FABRIC BANNER



This dye-sublimated lightweight fabric banner allows wind to pass through, making it great for outdoor use.

- Multiple finishing styles available (see page 57)
- Banners used outdoors have a 90-day warranty; banners used indoors have a 1-year warranty

### Super Poly Knit Fabric Banner

Item #	Description	Product Wt.	1-2	3-7	8-22	23-49
304420	2' x 4'	0.21 lb.	82.05	73.25	65.60	59.00
Item #	Description	Product Wt.	1	2-4	5-14	15-33
304421	2' x 6'	0.32 lb.	123.00	109.90	98.40	88.45
Item #	Description	Product Wt.	1	2-3	4-9	10-22
304424	3' x 6'	0.48 lb.	184.60	164.90	147.70	132.70
Item #	Description	Product Wt.	1-2	3-7	8-16	17-33
304425	3' x 8'	0.65 lb.	219.60	196.70	176.80	155.60
Item #	Description	Product Wt.	1	2-5	6-12	13-24
304427	4' x 8'	0.86 lb.	293.00	262.25	235.80	207.60
Item #	Description	Product Wt.	1	2-4	5-9	10-19
304430	5' x 8'	1.08 lbs.	366.25	328.00	294.75	259.50

Setup fee: \$20(G)

Pricing is subject to change.

USD MSRP (C)



3' x 6' banner with custom grommet placement



2' x 4' banner with pole pockets

## SATIN BANNER



Satin fabric has a formal appearance and an elegant finish, making it a crowd-pleaser at indoor events.

- Full-color, dye-sublimated graphics
- Multiple finishing styles available (see page 57)

### Satin Banner

Item #	Description	Product Wt.	1-2	3-7	8-22	23-49
304740	2' x 4'	0.2 lb.	65.00	60.05	55.70	52.45
Item #	Description	Product Wt.	1	2-3	4-9	10-22
304741	3' x 6'	0.45 lb.	146.20	135.10	125.30	117.90
Item #	Description	Product Wt.	1-2	3-7	8-16	17-33
304742	3' x 8'	0.6 lb.	180.50	167.30	157.60	146.60
304743	4' x 6'	0.6 lb.	180.50	167.30	157.60	146.60
Item #	Description	Product Wt.	1	2-5	6-12	13-24
304744	4' x 8'	0.8 lb.	240.60	223.10	210.10	195.40

Setup fee: \$20(G)

Pricing is subject to change.

USD MSRP (C)



3' x 6' banner with pole pockets



## BOULEVARD BANNERS



High-quality banners lend an upscale flair to any street or parking lot.

- Finished with 3" pole pockets on top and bottom
- Bracket system sold separately (see page 67)
- Custom sizes available (call for quote; restrictions may apply)
- Banners used outdoors have a 90-day warranty; banners used indoors have a 1-year warranty



30" x 72" vinyl banner



Strong Titan™  
18 oz. opaque  
scrim vinyl.

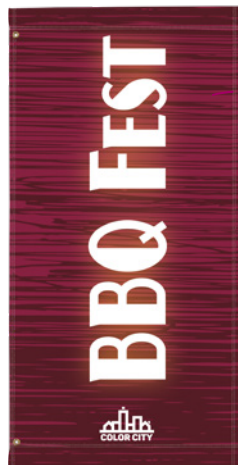

30" x 60" fabric banner

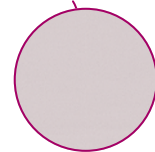

600 denier polyester  
is double-sided with  
block-out liner.

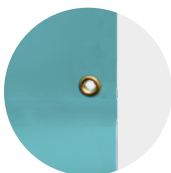

Two grommets  
along one edge  
of the banner.

### Vinyl Boulevard Banner (Double-Sided)

Item #	Description	Product Wt.	1-4	5-13	14-39	40-88
302031	18" x 36"	1.12 lbs.	51.15	48.09	44.71	42.00
Item #	Description	Product Wt.	1-3	4-9	10-29	30-66
302033	18" x 48"	1.5 lbs.	68.20	64.10	59.60	56.00
302035	24" x 36"	1.5 lbs.	68.20	64.10	59.60	56.00
Item #	Description	Product Wt.	1-2	3-7	8-22	23-49
302037	24" x 48"	2 lbs.	90.95	85.50	79.50	74.65
Item #	Description	Product Wt.	1	2-5	6-17	18-39
302039	24" x 60"	2.5 lbs.	113.70	106.90	99.35	93.35
Item #	Description	Product Wt.	1	2-4	5-14	15-33
302041	24" x 72"	3 lbs.	136.40	128.20	119.20	112.00
Item #	Description	Product Wt.	1	2-3	4-11	12-24
302043	24" x 96"	4 lbs.	181.90	171.00	159.00	149.30
Item #	Description	Product Wt.	1	2-4	5-14	15-31
302045	30" x 60"	3.12 lbs.	142.10	133.60	124.20	116.70
Item #	Description	Product Wt.	1	2-3	4-11	12-26
302047	30" x 72"	3.75 lbs.	170.50	160.30	149.00	140.00
Item #	Description	Product Wt.	1	2-3	4-10	11-22
302049	30" x 84"	4.5 lbs.	199.00	187.00	173.90	163.30

Setup fee: \$20(G)

Pricing is subject to change.

Banner only. Hardware sold separately (see page 67).  
Single-sided banners are available online.

USD MSRP (C)

### Fabric Boulevard Banner (Double-Sided)

Item #	Description	Product Wt.	1	2-5	6-11	12-24
302078	18" x 36"	0.6 lb.	186.90	171.90	160.70	149.50
302079	18" x 48"	0.8 lb.	200.20	184.20	172.20	160.20
302080	24" x 36"	0.8 lb.	209.50	192.70	180.10	167.60
302081	24" x 48"	1 lb.	216.20	198.90	186.00	173.00
302082	24" x 60"	1.2 lbs.	229.60	211.20	197.50	183.70
302083	24" x 72"	1.4 lbs.	243.00	223.50	208.90	194.40
302084	24" x 96"	2 lbs.	277.50	255.50	238.70	222.10
302085	30" x 60"	1.6 lbs.	277.50	255.50	238.70	222.10
302086	30" x 72"	1.8 lbs.	298.75	275.00	257.00	239.00
302087	30" x 84"	2 lbs.	305.50	281.00	262.75	244.30

Setup fee: \$20(G)

Pricing is subject to change.

Banner only. Hardware sold separately (see page 67).

USD MSRP (C)

VINYL FABRIC production lead time after final proof approval  
**24 DAYS**

**PRICES ARE SUBJECT TO CHANGE.** No setup fee on orders placed via our website. Visit [showdowndisplays.com](http://showdowndisplays.com) for current pricing, graphic templates, product videos and assembly instructions. See pages 288-291 for order details.

SHOWDOWNDISPLAYS.COM · ASI 87188 · PPAI 254687 · SAGE 67383 · PPPC 20101202

## VERSATILE BRACKET SYSTEM



Designed to be adaptable, this bracket system mounts to most standard wood and steel poles.

- Rust-free cast aluminum with fiberglass arms
- Stainless steel bands hold brackets in place
- Works with square, round, and polygonal poles
- 1° incline keeps banner taut
- Accepts banners up to 24 sq. ft. in size

### Versatile Bracket System

Item #	Description	Product Wt.	1-9	10-24	25-49	50-99
302020	18" Single	3 lbs.	121.50	115.50	107.00	102.10
302006	24" Single	3.25 lbs.	122.80	116.70	108.10	103.20
302008	30" Single	3.75 lbs.	128.10	121.70	112.70	107.60
302022	36" Single	4 lbs.	137.50	130.60	121.00	115.50
302021	18" Double	5.25 lbs.	197.50	187.60	173.80	165.90
302007	24" Double	6 lbs.	204.20	193.90	179.70	171.50
302009	30" Double	6.75 lbs.	220.20	209.20	193.70	184.90
302023	36" Double	7.5 lbs.	240.30	228.30	211.50	201.90

Pricing is subject to change.

Hardware only. Banner sold separately (see page 66).

USD MSRP (C)

Cast aluminum brackets



## PREMIUM BRACKET SYSTEM



This bracket system is built to withstand the harshest outdoor elements.

U.S. Patent# 6378820.

- Premium Single includes two Premium arms (one top, one bottom)
- Premium Double includes four Premium arms (two top, two bottom)
- Premium Single with Spring Arm includes one top Premium arm and one bottom spring arm
- Premium Double with Spring Arm includes two top Premium arms and two bottom spring arms



The spring arm has a 1° incline to keep banners taut and easily snaps back into place after banner changes.

### Premium Bracket System

Item #	Description	Product Wt.	1	2-5	6-11	12-24
302060	30" Single	5.25 lbs.	169.50	155.90	145.70	135.60
302062	30" Single w/Spring Arm	6 lbs.	213.40	196.30	183.50	170.70
302061	30" Double	10 lbs.	288.00	265.00	247.60	230.40
302063	30" Double w/Spring Arm	11.5 lbs.	363.75	334.75	313.00	291.00

Pricing is subject to change.

Hardware only. Banner sold separately (see page 66).

USD MSRP (C)

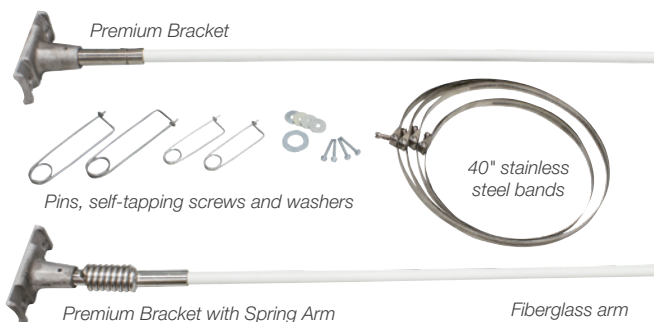

## WALL-MOUNT BRACKET SYSTEM



Rust-free cast aluminum brackets let you attach a banner to any wall, whether indoors or out.

### Wall-Mount Bracket System

Item #	Description	Product Wt.	1	10	100	250
302200	18" Bracket System	3.5 lbs.	101.40	96.35	89.25	85.20
302201	24" Bracket System	4 lbs.	101.40	96.35	89.25	85.20
302202	30" Bracket System	6 lbs.	101.40	96.35	89.25	85.20
302203	36" Bracket System	6.5 lbs.	101.40	96.35	89.25	85.20

Pricing is subject to change.

Hardware only; screws/bolts not included.

USD MSRP (C)

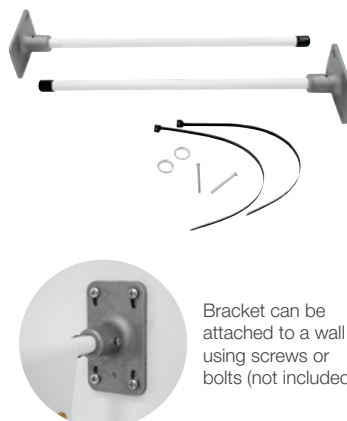

Bracket can be attached to a wall using screws or bolts (not included).





3' x 8' with straight bottom and gold fringe

## PARADE BANNER



Bring attention to your organization at parades and events.

- Great for parades, marching bands, organizations, schools and companies
- Available in two shapes; straight and scallop bottom
- Banner is double-sided on recycled polyester knit
- 100% recycled media is made with fibers recycled from plastic bottles
- Backside can be flooded with matching color; no other print design allowed
- Interior liner added to prevent wind distortion
- Select banner with or without gold fringe along the bottom
- Included sectional aluminum pole allows for banner to be carried with ease



3' x 6' with straight bottom

3' x 6' with scallop bottom



Enrich the look of your banner by choosing a banner option with gold fringe.

### Parade Banner

Item #	Description	Product Wt.	1	2-5	6-11	12-24
286200	3' x 6' Straight Bottom Kit	3.9 lbs.	327.00	300.75	281.25	261.50
286201	3' x 6' Straight Bottom Kit w/ Gold Fringe	4.1 lbs.	354.00	325.50	304.50	283.25
286202	3' x 6' Scallop Bottom Kit	3.6 lbs.	327.00	300.75	281.25	261.50
286203	3' x 6' Scallop Bottom Kit w/ Gold Fringe	3.9 lbs.	354.00	325.50	304.50	283.25
286209	3' x 8' Straight Bottom Kit	4.8 lbs.	411.25	378.25	353.75	329.00
286210	3' x 8' Straight Bottom Kit w/ Gold Fringe	5.2 lbs.	444.25	408.75	382.25	355.50
286211	3' x 8' Scallop Bottom Kit	4.4 lbs.	411.25	378.25	353.75	329.00
286212	3' x 8' Scallop Bottom Kit w/ Gold Fringe	5 lbs.	444.25	408.75	382.25	355.50
286218	3' x 10' Straight Bottom Kit	6.15 lbs.	494.00	454.50	424.75	395.25
286219	3' x 10' Straight Bottom Kit w/ Gold Fringe	7 lbs.	527.00	485.00	453.25	421.75
286220	3' x 10' Scallop Bottom Kit	5.7 lbs.	494.00	454.50	424.75	395.25
286221	3' x 10' Scallop Bottom Kit w/ Gold Fringe	6.7 lbs.	527.00	485.00	453.25	421.75

Setup fee: \$20(G)

Kit Includes: Pole Hardware and Graphic

Pricing is subject to change.

USD MSRP (C)



For best results, push swedge poles into the ground and hold the top half of each side to keep it taut.



Included rope loops through grommets to keep the banner secure and taut.



Hook-and-loop fasteners are strong enough to hold the two panels together but make the banner easy to burst through.

## TEARAWAY BANNER



Create a grand entrance at sporting events with a Tearaway Banner. Burst it apart and put it back together again!

- Artwork is printed on recycled polyester knit
- 100% recycled media is made with fibers recycled from plastic bottles
- The tearaway banner is made of two panels that attach to one another using hook-and-loop fasteners
- Each panel features a 3" pole pocket along the edge; pole pockets are closed at the top to prevent the banner from sliding down the poles
- Double-needle hem along the non-pole-pocket edge
- Banners used outdoors have a 90-day warranty; banners used indoors have a 1-year warranty

### Tearaway Banner

Item #	Description	Product Wt.	1	2-5	6-11	12-24
304680	6' x 10' Kit	3 lbs.	514.00	472.75	442.00	411.00
304682	8' x 12' Kit	7.5 lbs.	774.00	712.00	666.00	619.50
304684	10' x 15' Kit	6.5 lbs.	1102.00	1014.00	947.50	881.50

Setup fee: \$20(G)

Kit Includes: Pole Hardware, 2 - 12' Rope and Graphic

Pricing is subject to change.

USD MSRP (C)

production lead time after final proof approval

**4 DAYS**

PRICES ARE SUBJECT TO CHANGE. No setup fee on orders placed via our website.

Visit [showdowndisplays.com](http://showdowndisplays.com) for current pricing, graphic templates, product videos and assembly instructions. See pages 288-291 for order details.

SHOWDOWNDISPLAYS.COM · ASI 87188 · PPAI 254687 · SAGE 67383 · PPPC 20101202



# BUILD YOUR OWN FLAGS

WITH OUR QUICK & EASY ONLINE TOOL

Visit our website for accurate quotes and hassle-free ordering 24/7!

Under the Banners & Flags tab, click **Build Your Own Flags**.

Accurate Quoting · Large Quantities (max 50) · Additional Finishing Styles · Custom Sizes



## FLAG MATERIAL COMPARISON CHART

BEST SELLERS ★	MATERIAL CONSTRUCTION	WIND RATING	BEST USE	COLOR FASTNESS	REVERSE SIDE COLOR	SHAPES
200 Denier Nylon ★	Tightly woven threads provide better longevity and hold color longer.	6 <sub>2</sub>	Recommended for Indoor and Outdoor Use	★★★★	Reverse image will show through on back; color is vibrant on both sides.	
Super Poly Knit ★	Knitted fibers create a lightweight material that holds up well in windy conditions.	4 <sub>2</sub>	Recommended for Outdoor Use	★★★	Reverse image will show through on back; color is muted on back side.	
Super Poly Knit with Block-Out Polyester ★	Knitted fibers with a block-out polyester create a lightweight material that holds up well in windy conditions for double-sided flags.	4 <sub>2</sub>	Recommended for Outdoor Use	★★★	Image printed correctly on each side for double-sided flags; color is vibrant on both sides.	

**Beaufort Wind Rating:** See rating icon underneath the product name. Wind ratings were determined utilizing all available securing/stabilizing options sold with or offered for the product. See page 291 for details.

### Popular Finishing Styles

Details and additional finishing styles available online.

#### Header

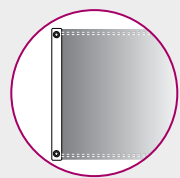

**Canvas Header & Grommets**  
(Standard Finishing)

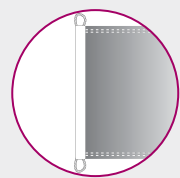

**Canvas Header & Rope/Thimble**  
(Recommended for flags that are 8' x 12' or larger)

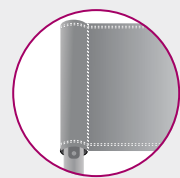

**3" Pole Sleeve Visible, Closed at Top, Leather Tab**

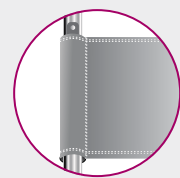

**3" Pole Sleeve Visible, Open at Top, Leather Tab**

#### Edges

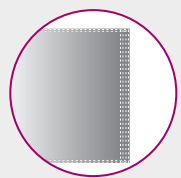

**4-Row Lock-Stitching**

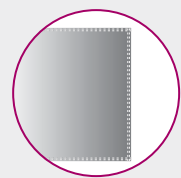

**Double Needle Lock-Stitching**

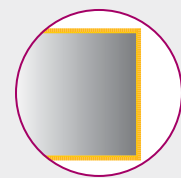

**Gold Fringe**

## NYLON FLAG



Lightweight and fade-resistant, our nylon flags come in a variety of shapes and sizes and are perfect for indoor and outdoor use.

- Constructed of 200 denier nylon
- Standard finishing includes canvas header and brass grommets
- Four rows of lock-stitching provide extra reinforcement on the fly end of rectangular flags
- Single- and double-sided options available
- Flags that are 8' x 12' and larger contain lap seams
- Custom sizes and finishing available (visit website or call for quote; restrictions may apply)
- Flags used outdoors have a 90-day warranty; flags used indoors have a 1-year warranty
- Not eligible for Rush Service



Rectangle: The oldest and most common shape in advertising

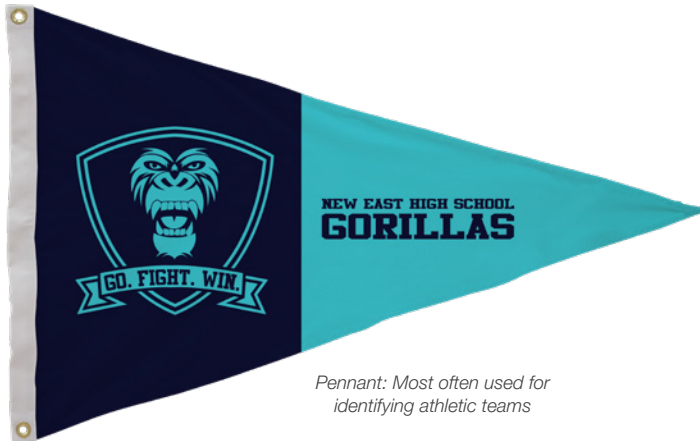

Pennant: Most often used for identifying athletic teams



### Rectangle Nylon Flag (Single-Sided)

Item #	Description	Product Wt.	1	2-5	6-11	12-24
304530	8" x 12"	0.25 lb.	45.75	36.60	34.31	29.74
304531	12" x 18"	0.25 lb.	50.85	40.68	38.14	33.05
304532	16" x 24"	0.25 lb.	55.95	44.76	41.96	36.37
304533	2' x 3'	0.3 lb.	63.55	50.80	47.65	41.29
304534	2.5' x 4'	0.4 lb.	89.00	71.20	66.75	57.85
304535	3' x 5'	0.5 lb.	101.70	81.35	76.30	66.10
304536	4' x 6'	0.7 lb.	139.80	111.80	104.80	90.85
304537	5' x 8'	1 lb.	203.30	162.60	152.50	132.20
304538	6' x 10'	1.6 lbs.	292.50	233.90	219.30	190.10
304539	8' x 12'	2.9 lbs.	496.00	396.75	372.00	322.25
304540	10' x 15'	4.6 lbs.	826.00	661.00	619.50	537.00
304541	12' x 18'	6.5 lbs.	1208.00	966.50	906.00	785.00
304542	15' x 25'	13.25 lbs.	1780.00	1424.00	1335.00	1157.00
304543	20' x 30'	21 lbs.	3177.00	2542.00	2383.00	2065.00
304544	20' x 38'	26.6 lbs.	3813.00	3050.00	2860.00	2478.00
304545	25' x 40'	35 lbs.	4830.00	3864.00	3622.00	3139.00
304546	30' x 50'	52.5 lbs.	6735.00	5390.00	5055.00	4379.00
304547	30' x 60'	63 lbs.	8260.00	6610.00	6195.00	5370.00

Setup fee: \$20(G)

Pricing is subject to change.

USD MSRP (C)

### Rectangle Nylon Flag (Double-Sided)

Item #	Description	Product Wt.	1	2-5	6-11	12-24
304550	8" x 12"	0.75 lb.	91.50	73.20	68.65	59.50
304551	12" x 18"	0.75 lb.	101.70	81.35	76.30	66.10
304552	16" x 24"	0.75 lb.	111.90	89.55	83.95	72.75
304553	2' x 3'	0.9 lb.	127.10	101.60	95.30	82.60
304554	2.5' x 4'	1.2 lbs.	178.00	142.40	133.50	115.70
304555	3' x 5'	1.5 lbs.	203.30	162.60	152.50	132.20
304556	4' x 6'	2.1 lbs.	279.75	223.80	209.80	181.90
304557	5' x 8'	3 lbs.	406.75	325.50	305.00	264.50
304558	6' x 10'	4.8 lbs.	585.00	467.75	438.50	380.00

Setup fee: \$20(G)

Pricing is subject to change.

USD MSRP (C)

### Pennant Nylon Flag (Single-Sided)

Item #	Description	Product Wt.	1	2-5	6-11	12-24
304600	8" x 12"	0.25 lb.	45.75	36.60	34.31	29.74
304601	12" x 18"	0.25 lb.	50.85	40.68	38.14	33.05
304602	16" x 24"	0.25 lb.	55.95	44.76	41.96	36.37
304603	2' x 3'	0.25 lb.	63.55	50.80	47.65	41.29
304604	2.5' x 4'	0.4 lb.	89.00	71.20	66.75	57.85
304605	3' x 5'	0.5 lb.	101.70	81.35	76.30	66.10
304606	4' x 6'	0.7 lb.	139.80	111.80	104.80	90.85
304607	5' x 8'	1 lb.	203.30	162.60	152.50	132.20
304608	6' x 10'	1.6 lbs.	292.50	233.90	219.30	190.10

Setup fee: \$20(G)

Pricing is subject to change.

USD MSRP (C)

### Pennant Nylon Flag (Double-Sided)

Item #	Description	Product Wt.	1	2-5	6-11	12-24
304610	8" x 12"	0.75 lb.	91.50	73.20	68.65	59.50
304611	12" x 18"	0.75 lb.	101.70	81.35	76.30	66.10
304612	16" x 24"	0.75 lb.	111.90	89.55	83.95	72.75
304613	2' x 3'	0.75 lb.	127.10	101.60	95.30	82.60
304614	2.5' x 4'	1.2 lbs.	178.00	142.40	133.50	115.70
304615	3' x 5'	1.5 lbs.	203.30	162.60	152.50	132.20
304616	4' x 6'	2.1 lbs.	279.75	223.80	209.80	181.90
304617	5' x 8'	3 lbs.	406.75	325.50	305.00	264.50
304618	6' x 10'	4.8 lbs.	585.00	467.75	438.50	380.00

Setup fee: \$20(G)

Pricing is subject to change.

USD MSRP (C)

**Guidon Nylon Flag (Single-Sided)**

Item #	Description	Product Wt.	1	2-5	6-11	12-24
304580	8" x 12"	0.25 lb.	45.75	36.60	34.31	29.74
304581	12" x 18"	0.25 lb.	50.85	40.68	38.14	33.05
304582	16" x 24"	0.25 lb.	55.95	44.76	41.96	36.37
304589	20" x 27.75"	0.2 lb.	61.00	48.80	45.75	39.65
304583	2' x 3'	0.25 lb.	63.55	50.80	47.65	41.29
304584	2.5' x 4'	0.4 lb.	89.00	71.20	66.75	57.85
304585	3' x 5'	0.5 lb.	101.70	81.35	76.30	66.10
304586	4' x 6'	0.7 lb.	139.80	111.80	104.80	90.85
304587	5' x 8'	1 lb.	203.30	162.60	152.50	132.20
304588	6' x 10'	1.6 lbs.	292.50	233.90	219.30	190.10

Setup fee: \$20(G)

Pricing is subject to change.

USD MSRP (C)

**Guidon Nylon Flag (Double-Sided)**

Item #	Description	Product Wt.	1	2-5	6-11	12-24
304590	8" x 12"	0.75 lb.	91.50	73.20	68.65	59.50
304591	12" x 18"	0.75 lb.	101.70	81.35	76.30	66.10
304592	16" x 24"	0.75 lb.	111.90	89.55	83.95	72.75
304609	20" x 27.75"	0.4 lb.	122.00	97.60	91.50	79.30
304593	2' x 3'	0.75 lb.	127.10	101.60	95.30	82.60
304594	2.5' x 4'	1.2 lbs.	178.00	142.40	133.50	115.70
304595	3' x 5'	1.5 lbs.	203.30	162.60	152.50	132.20
304596	4' x 6'	2.1 lbs.	279.75	223.80	209.80	181.90
304597	5' x 8'	3 lbs.	406.75	325.50	305.00	264.50
304598	6' x 10'	4.8 lbs.	585.00	467.75	438.50	380.00

Setup fee: \$20(G)

Pricing is subject to change.

USD MSRP (C)

**Burgee Nylon Flag (Single-Sided)**

Item #	Description	Product Wt.	1	2-5	6-11	12-24
304560	8" x 12"	0.25 lb.	45.75	36.60	34.31	29.74
304561	12" x 18"	0.25 lb.	50.85	40.68	38.14	33.05
304562	16" x 24"	0.25 lb.	55.95	44.76	41.96	36.37
304563	2' x 3'	0.25 lb.	63.55	50.80	47.65	41.29
304564	2.5' x 4'	0.4 lb.	89.00	71.20	66.75	57.85
304565	3' x 5'	0.5 lb.	101.70	81.35	76.30	66.10
304566	4' x 6'	0.7 lb.	139.80	111.80	104.80	90.85
304567	5' x 8'	1 lb.	203.30	162.60	152.50	132.20
304568	6' x 10'	1.6 lbs.	292.50	233.90	219.30	190.10

Setup fee: \$20(G)

Pricing is subject to change.

USD MSRP (C)

**Burgee Nylon Flag (Double-Sided)**

Item #	Description	Product Wt.	1	2-5	6-11	12-24
304570	8" x 12"	0.75 lb.	91.50	73.20	68.65	59.50
304571	12" x 18"	0.75 lb.	101.70	81.35	76.30	66.10
304572	16" x 24"	0.75 lb.	111.90	89.55	83.95	72.75
304573	2' x 3'	0.75 lb.	127.10	101.60	95.30	82.60
304574	2.5' x 4'	1.2 lbs.	178.00	142.40	133.50	115.70
304575	3' x 5'	1.5 lbs.	203.30	162.60	152.50	132.20
304576	4' x 6'	2.1 lbs.	279.75	223.80	209.80	181.90
304577	5' x 8'	3 lbs.	406.75	325.50	305.00	264.50
304578	6' x 10'	4.8 lbs.	585.00	467.75	438.50	380.00

Setup fee: \$20(G)

Pricing is subject to change.

USD MSRP (C)



Guidon: Commonly used for promoting military units



Burgee: Traditionally used for signaling and identifying watercraft

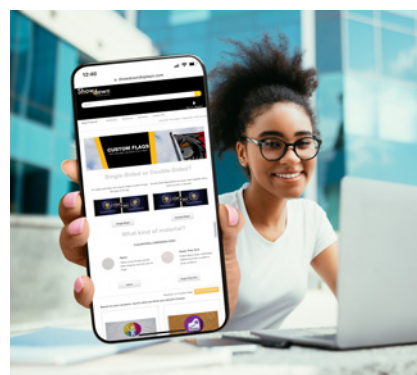

**Single-Sided**



Single-sided flags are printed on one side; reverse image shows through the back.

**Double-Sided**



Double-sided flags have the image printed correctly on both sides with a block-out polyester liner.

## UNITED STATES FLAG



Let your patriotism fly high with these beautifully constructed durable flags.

- Flags are constructed of the finest 200 denier nylon, special woven two-ply polyester or polycotton
- Dyed with UV protected fade-resistant inks for longer-lasting colors with seamless transitions
- Nylon and polyester flags feature embroidered stars and hand-sewn stripes for an authentic high-quality flag
- Polycotton flag is a 100% printed flag
- Superior wearing quality dries quickly and stands up to the elements
- Call your rep for lead times on USA Flags larger than 8' x 12'
- Flags used outdoors have a 90-day warranty; flags used indoors have a 1-year warranty



### United States Nylon Flag

Item #	Description	Product Wt.	1
48402	2' x 3'	0.3 lb.	33.23
48403	3' x 5'	0.6 lb.	44.36
48404	4' x 6'	0.85 lb.	61.70
48405	5' x 8'	1.3 lbs.	89.80
484059	5' x 9.5'	1.5 lbs.	113.50
48406	6' x 10'	1.9 lbs.	139.70
48408	8' x 12'	3.1 lbs.	259.00
48410	10' x 15'	5.3 lbs.	380.75

Pricing is subject to change.  
USD MSRP (C)

### United States Polyester Flag

Item #	Description	Product Wt.	1
48803	3' x 5'	1 lb.	55.70
48804	4' x 6'	1.5 lbs.	73.35
48805	5' x 8'	2.2 lbs.	113.90
48806	6' x 10'	3.3 lbs.	171.50
48808	8' x 12'	5.3 lbs.	289.50
48810	10' x 15'	8.5 lbs.	445.00
48812	12' x 18'	11.9 lbs.	645.50
48815	15' x 25'	19.7 lbs.	1082.00

Pricing is subject to change.  
USD MSRP (C)

### United States Polycotton Flag

Item #	Description	Product Wt.	1
484000	3' x 5'	0.4 lb.	24.27

Pricing is subject to change.  
USD MSRP (C)

### Nylon & Polyester United States Flags Feature

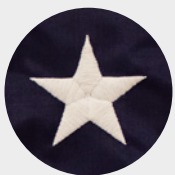

Flags feature full white embroidered stars, no gaps.

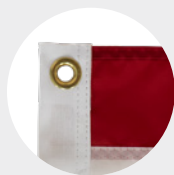

Flags up to 6' x 10' are finished with a white canvas header and brass grommets; 8' x 12' and larger are finished with a rope and thimble header.

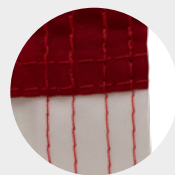

Fly end is finished with four-row lock-stitching.



Flags utilize a quarter-inch turn-in on all seams to reduce fraying.

when ordered before 2 pm central

**FLAG SHIPS  
SAME DAY**

CALL YOUR REP FOR LEAD TIMES ON USA FLAGS LARGER THAN 8' X 12'

**PRICES ARE SUBJECT TO CHANGE.** No setup fee on orders placed via our website.

Visit [showdowndisplays.com](http://showdowndisplays.com) for current pricing, graphic templates, product videos and assembly instructions. See pages 288-291 for order details.

SHOWDOWNDISPLAYS.COM · ASI 87188 · PPAI 254687 · SAGE 67383 · PPPC 20101202

## STATE FLAGS



Fly your state flag with pride and let us know where you're from. We offer flags for all 50 states as well as U.S. territories.

- Great for indoor or outdoor use
- Artwork is printed on 200 denier nylon
- Finished with canvas header and brass grommets
- Flags are single-sided
- See the complete selection of State Flags available online
- Flags used outdoors have a 90-day warranty; flags used indoors have a 1-year warranty
- Not eligible for Rush Service



West Virginia



Alabama



New Jersey



### State Flags

Item #	Description	Product Wt.	1
285800	2' x 3'	0.25 lb.	22.88
285801	3' x 5'	0.5 lb.	40.67
285802	4' x 6'	0.7 lb.	62.25
285803	5' x 8'	1 lb.	105.60
285804	6' x 10'	1.6 lbs.	152.50

Setup fee: \$20(G)

Pricing is subject to change.

USD MSRP (C)

## CANADA PROVINCE FLAGS



Canadian Province Flags offer a vibrant and durable way to showcase provincial pride, perfect for indoor or outdoor displays.

- Artwork is printed on 200 denier nylon
- Finished with canvas header and brass grommets
- Flags are single-sided
- See the complete selection of Canada Province Flags available online
- Flags used outdoors have a 90-day warranty; flags used indoors have a 1-year warranty
- Not eligible for Rush Service



Manitoba



Yukon



Prince Edward Island



### Canada Province Flags

Item #	Description	Product Wt.	1
285870	2' x 3'	0.25 lb.	33.36
285871	3' x 5'	0.5 lb.	60.10
285872	4' x 6'	0.7 lb.	84.10
285873	5' x 8'	1 lb.	125.60
285874	6' x 10'	1.6 lbs.	186.90

Setup fee: \$20(G)

Pricing is subject to change.

USD MSRP (C)

**PRICES ARE SUBJECT TO CHANGE.** No setup fee on orders placed via our website. Visit [showdowndisplays.com](http://showdowndisplays.com) for current pricing, graphic templates, product videos and assembly instructions. See pages 288-291 for order details.

SHOWDOWNDISPLAYS.COM · ASI 87188 · PPAI 254687 · SAGE 67383 · PPPC 20101202

production lead time  
after final proof approval  
**4 DAYS**

## FABRIC FLAG



Easy to hang, these flags work with any standard flagpole.

- Best for outdoor use
- Single- and double-sided options available
- Artwork is dye sublimated on super poly knit fabric for single-sided flags and on block-out polyester for double-sided flags
- Custom sizes and finishing available (visit website or call for quote; restrictions may apply)
- Flags used outdoors have a 90-day warranty; flags used indoors have a 1-year warranty



Rectangle: The oldest and most common shape in advertising

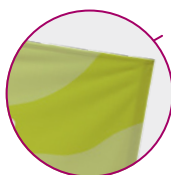

Double-sided flags feature a lightweight block-out polyester for increased flyability.



Pennant: Most often used for identifying athletic teams

### Rectangle Fabric Flag (Single-Sided)

Item #	Description	Product Wt.	1	2-5	6-11	12-24
191900	8" x 12"	0.04 lb.	48.04	38.43	36.03	31.23
191901	12" x 18"	0.06 lb.	53.40	42.71	40.04	34.70
191902	16" x 24"	0.12 lb.	58.75	47.00	44.06	38.19
300003	2' x 3'	0.25 lb.	66.70	53.35	50.05	43.36
191903	2.5' x 4'	0.25 lb.	93.45	74.75	70.05	60.75
300007	3' x 5'	0.5 lb.	106.80	85.45	80.10	69.40
300011	4' x 6'	1 lb.	146.80	117.40	110.10	95.40
300015	5' x 8'	1.25 lbs.	213.50	170.80	160.10	138.80
300071	6' x 10'	1.5 lbs.	307.00	245.60	230.30	199.60
191904	8' x 12'	5 lbs.	520.50	416.50	390.50	338.50
191905	10' x 15'	6 lbs.	867.50	694.00	650.50	564.00

Setup fee: \$20(G)

Pricing is subject to change.

USD MSRP (C)

### Rectangle Fabric Flag (Double-Sided)

Item #	Description	Product Wt.	1	2-5	6-11	12-24
191906	8" x 12"	0.08 lb.	96.10	76.85	72.05	62.45
191907	12" x 18"	0.12 lb.	106.80	85.45	80.10	69.40
191908	16" x 24"	0.24 lb.	117.50	94.00	88.15	76.40
300018	2' x 3'	0.5 lb.	133.40	106.70	100.10	86.70
191909	2.5' x 4'	0.5 lb.	186.90	149.50	140.10	121.50
300019	3' x 5'	1 lb.	213.50	170.80	160.10	138.80
300020	4' x 6'	2 lbs.	293.75	235.00	220.30	190.90
300021	5' x 8'	2.5 lbs.	427.00	341.75	320.25	277.75
300072	6' x 10'	3 lbs.	614.00	491.25	460.50	399.00

Setup fee: \$20(G)

Pricing is subject to change.

USD MSRP (C)

### Pennant Fabric Flag (Single-Sided)

Item #	Description	Product Wt.	1	2-5	6-11	12-24
191910	8" x 12"	0.04 lb.	48.04	38.43	36.03	31.23
191911	12" x 18"	0.06 lb.	53.40	42.71	40.04	34.70
191912	16" x 24"	0.12 lb.	58.75	47.00	44.06	38.19
191913	2' x 3'	0.25 lb.	66.70	53.35	50.05	43.36
191914	2.5' x 4'	0.25 lb.	93.45	74.75	70.05	60.75
191915	3' x 5'	0.5 lb.	106.80	85.45	80.10	69.40
191916	4' x 6'	1 lb.	146.80	117.40	110.10	95.40
191917	5' x 8'	1.25 lbs.	213.50	170.80	160.10	138.80
191918	6' x 10'	1.5 lbs.	307.00	245.60	230.30	199.60

Setup fee: \$20(G)

Pricing is subject to change.

USD MSRP (C)

### Pennant Fabric Flag (Double-Sided)

Item #	Description	Product Wt.	1	2-5	6-11	12-24
191919	8" x 12"	0.08 lb.	95.80	76.65	71.85	62.30
191920	12" x 18"	0.12 lb.	106.80	85.45	80.10	69.40
191921	16" x 24"	0.24 lb.	117.50	94.00	88.15	76.40
191922	2' x 3'	0.5 lb.	133.40	106.70	100.10	86.70
191923	2.5' x 4'	0.5 lb.	186.90	149.50	140.10	121.50
191924	3' x 5'	1 lb.	213.50	170.80	160.10	138.80
191925	4' x 6'	2 lbs.	293.75	235.00	220.30	190.90
191926	5' x 8'	2.5 lbs.	427.00	341.75	320.25	277.75
191927	6' x 10'	3 lbs.	614.00	491.25	460.50	399.00

Setup fee: \$20(G)

Pricing is subject to change.

USD MSRP (C)

### Guidon Fabric Flag (Single-Sided)

Item #	Description	Product Wt.	1	2-5	6-11	12-24
191928	8" x 12"	0.04 lb.	48.04	38.43	36.03	31.23
191929	12" x 18"	0.06 lb.	53.40	42.71	40.04	34.70
191930	16" x 24"	0.12 lb.	58.75	47.00	44.06	38.19
191931	20" x 27.75"	0.2 lb.	64.05	51.25	48.04	41.63
191932	2' x 3'	0.25 lb.	66.70	53.35	50.05	43.36
191933	2.5' x 4'	0.25 lb.	93.45	74.75	70.05	60.75
191934	3' x 5'	0.5 lb.	106.80	85.45	80.10	69.40
191935	4' x 6'	1 lb.	146.80	117.40	110.10	95.40
191936	5' x 8'	1.25 lbs.	213.50	170.80	160.10	138.80
191937	6' x 10'	1.5 lbs.	307.00	245.60	230.30	199.60

Setup fee: \$20(G)

Pricing is subject to change.

USD MSRP (C)

### Guidon Fabric Flag (Double-Sided)

Item #	Description	Product Wt.	1	2-5	6-11	12-24
191938	8" x 12"	0.08 lb.	96.10	76.85	72.05	62.45
191939	12" x 18"	0.12 lb.	106.80	85.45	80.10	69.40
191940	16" x 24"	0.24 lb.	117.50	94.00	88.15	76.40
191941	20" x 27.75"	0.4 lb.	128.10	102.50	96.10	83.25
191942	2' x 3'	0.5 lb.	133.40	106.70	100.10	86.70
191943	2.5' x 4'	0.5 lb.	186.90	149.50	140.10	121.50
191944	3' x 5'	1 lb.	213.50	170.80	160.10	138.80
191945	4' x 6'	2 lbs.	293.75	235.00	220.30	190.90
191946	5' x 8'	2.5 lbs.	427.00	341.75	320.25	277.75
191947	6' x 10'	3 lbs.	614.00	491.25	460.50	399.00

Setup fee: \$20(G)

Pricing is subject to change.

USD MSRP (C)

### Burgee Fabric Flag (Single-Sided)

Item #	Description	Product Wt.	1	2-5	6-11	12-24
191948	8" x 12"	0.04 lb.	48.04	38.43	36.03	31.23
191949	12" x 18"	0.06 lb.	53.40	42.71	40.04	34.70
191950	16" x 24"	0.12 lb.	58.75	47.00	44.06	38.19
191951	2' x 3'	0.25 lb.	66.70	53.35	50.05	43.36
191952	2.5' x 4'	0.25 lb.	93.45	74.75	70.05	60.75
191953	3' x 5'	0.5 lb.	106.80	85.45	80.10	69.40
191954	4' x 6'	1 lb.	146.80	117.40	110.10	95.40
191955	5' x 8'	1.25 lbs.	213.50	170.80	160.10	138.80
191956	6' x 10'	1.5 lbs.	307.00	245.60	230.30	199.60

Setup fee: \$20(G)

Pricing is subject to change.

USD MSRP (C)

### Burgee Fabric Flag (Double-Sided)

Item #	Description	Product Wt.	1	2-5	6-11	12-24
191957	8" x 12"	0.08 lb.	96.10	76.85	72.05	62.45
191958	12" x 18"	0.12 lb.	106.80	85.45	80.10	69.40
191959	16" x 24"	0.24 lb.	117.50	94.00	88.15	76.40
191960	2' x 3'	0.5 lb.	133.40	106.70	100.10	86.70
191961	2.5' x 4'	0.5 lb.	186.90	149.50	140.10	121.50
191962	3' x 5'	1 lb.	213.50	170.80	160.10	138.80
191963	4' x 6'	2 lbs.	293.75	235.00	220.30	190.90
191964	5' x 8'	2.5 lbs.	427.00	341.75	320.25	277.75
191965	6' x 10'	3 lbs.	614.00	491.25	460.50	399.00

Setup fee: \$20(G)

Pricing is subject to change.

USD MSRP (C)



Guidon: Commonly used for promoting military units



Burgee: Traditionally used for signaling and identifying watercraft

### Single-Sided



Single-sided flags are printed on one side; reverse image shows through the back.

### Double-Sided

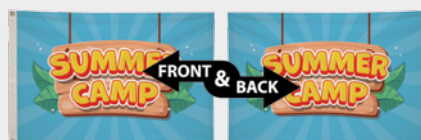

Double-sided flags have the image printed correctly on both sides with a block-out polyester.



Canvas header flag

Tube flag

## GOLF FLAG



This golf flag will give your course or event a personalized touch.

- Artwork is printed on 200 denier nylon
- Single-sided flags show artwork on one side with the reverse image visible through the back
- Double-sided flags feature two layers sewn together with a block-out liner in between
- Flags used outdoors have a 90-day warranty;
- flags used indoors have a 1-year warranty
- Not eligible for Rush Service



Available with canvas header and grommets or sewn-in golf tube.

### Golf Flag

Item #	Description	Product Wt.	1	2-5	6-11	12-24
304620	20" x 14" Canvas Header Flag Single-Sided	0.25 lb.	69.35	55.50	52.00	45.08
304621	20" x 14" Tube Flag Single-Sided	1 lb.	80.05	64.05	60.05	52.05
304622	20" x 14" Canvas Header Flag Double-Sided	1 lb.	138.70	111.00	104.00	90.15
304623	20" x 14" Tube Flag Double-Sided	1.75 lbs.	160.10	128.10	120.10	104.10

Setup fee: \$20(G)

Pricing is subject to change.

USD MSRP (C)



## CAR FLAG



Car flags are a great way to get attention while on the road.

- Can be used on cars in motion (45 mph maximum speed)
- Artwork is dye sublimated on super poly knit fabric for single-sided flags and on block-out polyester for double-sided flags
- 1.5" pole sleeve is closed at the top to prevent the flag from sliding down the pole
- The bottom of the sleeve features a leather tab that is zip-tied to the pole
- The Car Flag premium pole is constructed of high gauge plastic
- Double-sided flags feature a lightweight block-out polyester for increased flyability
- 30-day warranty on flag

### Car Flag

Item #	Description	Product Wt.	1	2-5	6-11	12-24
304690	18" x 12" Single-Sided Kit	0.5 lb.	77.40	71.25	66.60	61.95
304691	18" x 12" Double-Sided Kit	1 lb.	154.80	142.40	133.20	123.90

Setup fee: \$20(G)

Pricing is subject to change.

Kit Includes: Pole and Installed Graphic

USD MSRP (C)



To install, simply place the flagpole's clip on your window and roll up the window.

## PENNANT STRING



Dress up your balconies, decks, windows, and parade floats with these festive pennants.

- Single-sided pennants are printed on Titan™ 13 oz. scrim vinyl;
- double-sided pennants are printed on Titan™ 18 oz. opaque scrim vinyl
- Pennants are 9" x 12"
- Custom pennant strings available (call for quote; restrictions may apply)
- Pennants used outdoors have a 90-day warranty; pennants used indoors have a 1-year warranty

### Pennant String

Item #	Description	Product Wt.	1	2-5	6-11	12-24
304770	20' Single-Sided	0.6 lb.	121.40	111.70	104.40	97.15
304771	30' Single-Sided	0.8 lb.	177.40	163.20	152.60	141.90
304772	20' Double-Sided	0.8 lb.	194.90	179.30	167.60	155.90
304773	30' Double-Sided	1 lb.	284.25	261.50	244.40	227.40

Setup fee: \$20(G)

Pricing is subject to change.

USD MSRP (C)



20' strings feature 11 pennants, 30' strings feature 16 pennants



Rope is available in white only.

production lead time after final proof approval

**4 DAYS**

**PRICES ARE SUBJECT TO CHANGE.** No setup fee on orders placed via our website.

Visit [showdowndisplays.com](http://showdowndisplays.com) for current pricing, graphic templates, product videos and assembly instructions. See pages 288-291 for order details.

SHOWDOWNDISPLAYS.COM · ASI 87188 · PPAI 254687 · SAGE 67383 · PPPC 20101202

## STICK FLAG



These mini flags are great on desktops or as mementos.

- Perfect for parades and interactive events
- Available with a black staff and gold spear tip; 4" x 6" staff is hollow
- Flag is single-sided; finished with clean-cut edges and a pole sleeve
- Artwork is printed on 100 denier polyester
- Flags used outdoors have a 90-day warranty; flags used indoors have a 1-year warranty
- High volume opportunities available (call for quote; restrictions may apply)
- Not eligible for Rush Service

### Stick Flag

Item #	Description	Product Wt.	1	2-5	6-11	12-24
304640	4" x 6" (Set of 6)	0.9 lb.	96.10	76.85	72.05	62.45
304641	6" x 9" (Set of 6)	1.2 lbs.	112.20	89.75	84.15	72.95
304642	8" x 12" (Set of 6)	1.8 lbs.	160.10	128.10	120.10	104.10
304643	12" x 18" (Set of 6)	2.1 lbs.	192.20	153.70	144.10	124.90
304644	16" x 24" (Set of 6)	2.7 lbs.	208.30	166.60	156.20	135.40

Setup fee: \$20(G)

Pricing is subject to change.

USD MSRP (C)



6" x 9"

4" x 6"

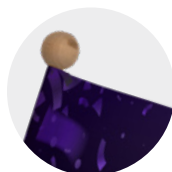

Stick Flags with gold ball tip and natural wood color staff are also available; see website.



250th Anniversary USA Stick Flag is available online.



Stick Flag Base available with 1, 2 or 3 holes (sold separately; see page 257). Base fits 4" x 6" Stick Flag only.

## SPIRIT FLAG



The Spirit Flag is a great way to energize the crowd.

- Single- and double-sided options available
- Artwork is printed on 200 denier nylon
- 3" pole sleeve is closed at the top to prevent the flag from sliding down the pole
- Flags used outdoors have a 90-day warranty; flags used indoors have a 1-year warranty
- Not eligible for Rush Service

### Spirit Flag

Item #	Description	Product Wt.	1	2-5	6-11	12-24
304650	3' x 5' Single-Sided Kit	1.45 lbs.	153.60	141.30	132.10	122.80
304651	3' x 5' Double-Sided Kit	2.35 lbs.	252.25	232.00	216.90	201.80
304654	4' x 6' Single-Sided Kit	1.7 lbs.	185.50	170.60	159.50	148.40
304655	4' x 6' Double-Sided Kit	3.1 lbs.	315.00	289.75	270.75	252.00
304658	5' x 8' Single-Sided Kit	2 lbs.	245.50	225.90	211.10	196.40
304659	5' x 8' Double-Sided Kit	4 lbs.	433.75	399.00	373.00	347.00
304662	6' x 10' Single-Sided Kit	4 lbs.	364.25	335.25	313.25	291.50
304663	6' x 10' Double-Sided Kit	5.6 lbs.	640.50	589.50	551.00	512.50
304666	8' x 12' Single-Sided Kit	7 lbs.	634.00	583.50	545.50	507.50
304667	8' x 12' Double-Sided Kit	12.7 lbs.	1168.00	1074.00	1004.00	934.00

Setup fee: \$20(G)

Pricing is subject to change.

Kit Includes: Pole Hardware and Graphic

USD MSRP (C)



Double-needle hem on the top and bottom; four rows of stitching on the fly end.



The bottom of the sleeve features a leather tab that can be zip-tied to the pole.



PRICES ARE SUBJECT TO CHANGE. No setup fee on orders placed via our website.

Visit [showdowndisplays.com](http://showdowndisplays.com) for current pricing, graphic templates, product videos and assembly instructions. See pages 288-291 for order details.

SHOWDOWNDISPLAYS.COM · ASI 87188 · PPAI 254687 · SAGE 67383 · PPPC 20101202

STICK SPIRIT production lead time after final proof approval  
**7-OR-4 DAYS**

# HIGH-IMPACT FLAGS THAT FLUTTER IN THE WIND

## SAIL SIGN COMPARISON CHART







BEST SELLERS ★		AVAILABLE SHAPES AND SIZES					DOUBLE-SIDED OPTION	MATERIAL		HARDWARE AND BASES		
GOOD	PG #	BLADE	RAZOR	FEATHER	TEARDROP	RECTANGLE		FLAG	POLE POCKET	HARDWARE	COMPATIBLE BASES	
NEW Value ★	80	7.5'	7.5'	7.5'	6.5'		✓	Super Poly Knit Block-out Polyester	same as flag material	value	<ul style="list-style-type: none"> <li>Flat Base</li> <li>Floor Mount</li> <li>Ground Spike</li> <li>Heavy-Duty Cross Base</li> <li>Tent Mounts</li> <li>Fence Mount</li> <li>Scissor Base</li> <li>Simple Spike</li> <li>Vehicle Base</li> <li>Wall Mount</li> </ul>	
		10.5'	10.5'	10.5'	9.5'							
		15'	15'	15'	13'							
Streamline ★	82	7'	7'		6'	7'	✓	Super Poly Knit Block-out Polyester	same as flag material	premium	<ul style="list-style-type: none"> <li>Three-Legged Base (6' &amp; 7' only)</li> <li>Flat Base</li> <li>Floor Mount</li> <li>Ground Spike</li> <li>Heavy-Duty Cross Base</li> <li>Tent Mounts</li> <li>Fence Mount</li> <li>Scissor Base</li> <li>Simple Spike</li> <li>Vehicle Base</li> <li>Wall Mount</li> </ul>	
		9'	9'		8'	10'						
		13'	13'		11.5'	14.5'						
		17'	17'		15'							
Premium ★	84	7'	7'		6'	7'	✓	Super Poly Knit Block-out Polyester	reinforced with premium elastic black pole sleeve	premium	<ul style="list-style-type: none"> <li>Three-Legged Base (6' &amp; 7' only)</li> <li>Flat Base</li> <li>Floor Mount</li> <li>Ground Spike</li> <li>Heavy-Duty Cross Base</li> <li>Tent Mounts</li> <li>Fence Mount</li> <li>Scissor Base</li> <li>Simple Spike</li> <li>Vehicle Base</li> <li>Wall Mount</li> </ul>	
		9'	9'		8'	10'						
		13'	13'		11.5'	14.5'						
		17'	17'		15'							
	Elite	86	7'	7'		6'			200 Denier Nylon	reinforced with premium elastic black pole sleeve	premium	<ul style="list-style-type: none"> <li>Three-Legged Base (6' &amp; 7' only)</li> <li>Flat Base</li> <li>Floor Mount</li> <li>Ground Spike</li> <li>Heavy-Duty Cross Base</li> <li>Tent Mounts</li> <li>Fence Mount</li> <li>Scissor Base</li> <li>Simple Spike</li> <li>Vehicle Base</li> <li>Wall Mount</li> </ul>
			9'	9'		8'						
			13'	13'		11.5'						
			17'	17'		15'						



**Beaufort Wind Rating: All standard sail signs have a wind rating of 6 (excludes Mini Teardrop Sail Sign).**

See rating icon underneath the product name. Wind ratings were determined utilizing all available securing/stabilizing options sold with or offered for the product. See page 291 for details.

## HARDWARE COMPARISON CHART

	POLE CONSTRUCTION	FLAG ATTACHMENT	CARRY CASE	HARDWARE WARRANTY
Value Hardware	 <p>Channeled carbon composite overlay construction with low-gloss black paint finish.</p> <p>Double-reinforced carbon fiber pole segment ends.</p>	 <p>A loop on the flag attaches to an adjustable hook on the pole.</p>	Sold separately (see page 81)	
Premium, Streamline and Elite Hardware	 <p>Uniform carbon composite overlay construction with high-gloss black paint finish.</p> <p>Polished aluminum collar pole segment ends and ergonomic, rubber-reinforced base grip.</p>	 <p>Flag attaches to a fixed hook using a bungee cord.</p>		

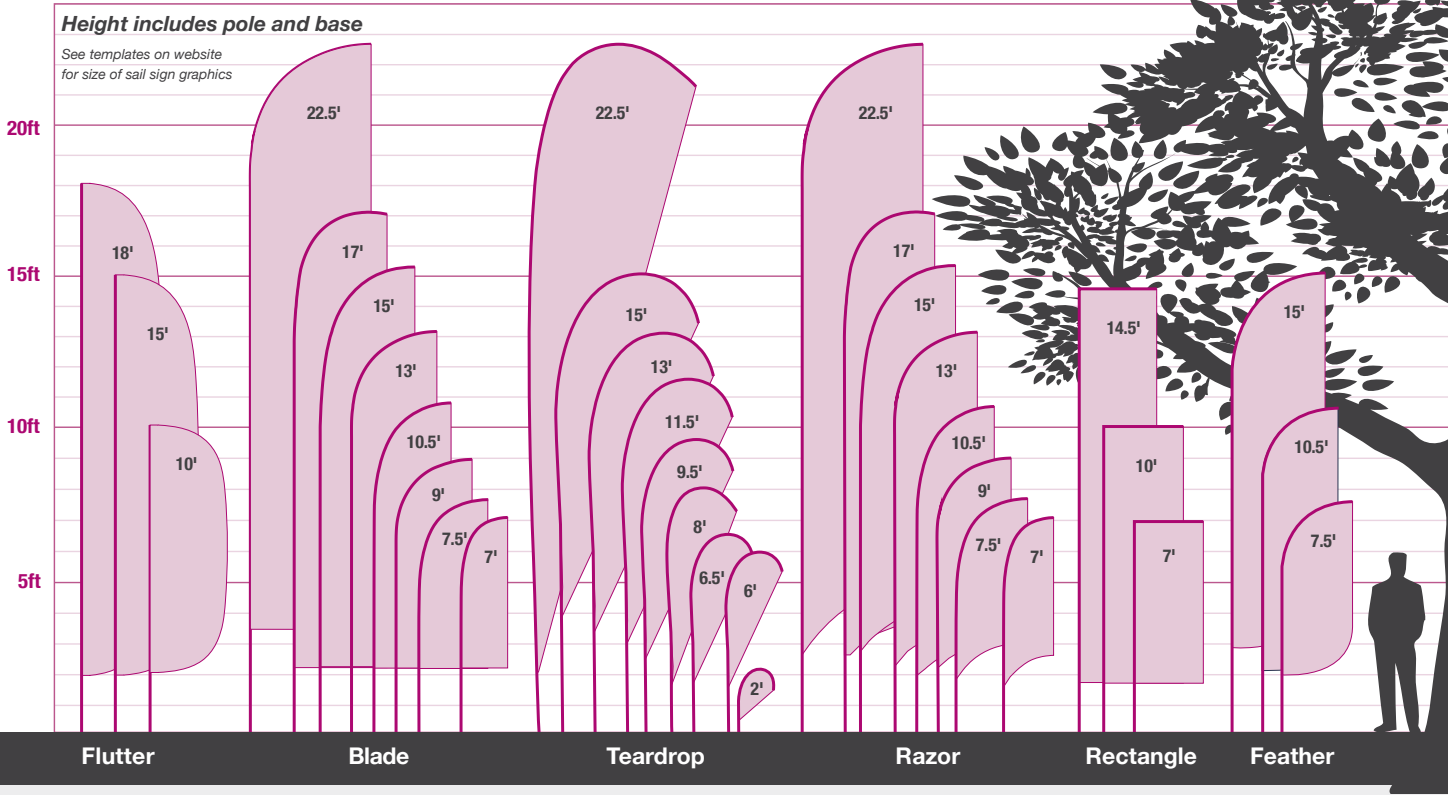

**Disclaimer:** Wind rating conducted in a controlled environment. Outdoor products should be taken down if bad weather is likely; wind gusts or heavy rain could reduce the wind resistance of these products.

## MAXIMIZE THE IMPACT OF YOUR MESSAGE



### Single-Sided

Image printed on one side; reverse image shows through back.



### Double-Sided

Image printed correct on both sides using a block-out polyester. (excludes Elite and Ascent sail signs)

## CUSTOMIZE WITH BASE OPTIONS

**Kits include spike, cross base with water ballast, or scissor base with water ballast.**

Select double-sided spike kits include the Ground Spike Anchor. We also carry several other bases designed to work on various types of terrain; see pages 90-91.



## VALUE SAIL SIGN



Value sail signs are a high quality budget-minded sail flag solution - perfect for indoor and short-term outdoor use.

- Sizes range from 6.5' to 15' tall
- Value spike for outdoor use or value cross base for indoor/outdoor use
- Carbon composite poles are strong and flexible
- Artwork is dye sublimated on super poly knit fabric for single-sided sail signs and on block-out polyester for double-sided sail signs
- 90-day warranty on hardware and flag
- Can be stored and transported in our Value sail sign soft carry case (sold separately)

## Single- or Double-Sided



### Single-Sided

Image printed on one side; reverse image shows through back.



### Double-Sided

Image printed correctly on both sides using a block-out polyester.



7.5' Feather    10.5' Razor    13' Teardrop    15' Razor    10.5' Blade    6.5' Teardrop



## Durable Construction



13' and 15' double-sided spike kits include the Ground Anchor spike; attach to Value spike for additional stability.

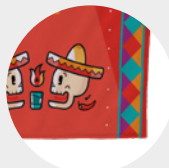

Double-sided flags feature a lightweight block-out polyester for increased flyability.

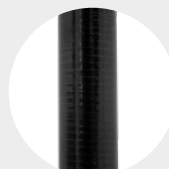

Channeled carbon composite overlay construction with low-gloss black paint finish.



A loop on the flag attaches to an adjustable hook on the pole.

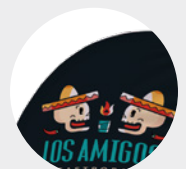

Pole pocket is made of the same fabric as the flag.

**Value Feather Sail Sign**

Description	Item #	Single-Sided Flag				Double-Sided Flag				
		1	2-5	6-11	12-24	Item #	1	2-5	6-11	12-24
7.5' Kit w/ Value Spike	191860	147.10	142.70	138.30	133.90	191862	232.20	225.30	218.30	211.30
7.5' Kit w/ Cross Base and Water Ballast	191861	204.30	198.20	192.10	185.90	191863	289.50	280.75	272.00	263.50
10.5' Kit w/ Value Spike	191864	174.50	169.20	164.00	158.80	191866	274.00	265.75	257.50	249.40
10.5' Kit w/ Cross Base and Water Ballast	191865	231.70	224.80	217.80	210.90	191867	331.25	321.25	311.25	301.50
15' Kit w/ Value Spike	191868	230.70	223.80	216.90	209.90	191870	373.75	362.75	351.50	340.25
15' Kit w/ Cross Base and Water Ballast	191869	288.00	279.25	270.75	262.00	191871	431.00	418.25	405.25	392.25

**Setup fee: \$20(G)**

Kit Includes: Hardware with Specified Base and Graphic (Does not include carry case)

Description	Product Size w/Spike	Product Size w/Cross Base	Finished Graphic Size	Product Wt. (Spike / Cross)	Media (Single / Double)
7.5'	28.5"W x 88.25"H x 1.5"D	43.5"W x 91.625"H x 23.75"D	view online template	3 lbs. / 4.3 lbs.	super poly knit fabric / block-out polyester
10.5'	30.25"W x 124"H x 1.5"D	45.25"W x 127.375"H x 23.75"D	view online template	3.8 lbs. / 5.1 lbs.	super poly knit fabric / block-out polyester
15'	35.5"W x 177"H x 1.5"D	50.5"W x 180.375"H x 23.75"D	view online template	5.6 lbs. / 6.3 lbs.	super poly knit fabric / block-out polyester

**Pricing is subject to change.**

USD MSRP (C)



**Value Blade Sail Sign**

Description	Item #	Single-Sided Flag				Double-Sided Flag				
		1	2-5	6-11	12-24	Item #	1	2-5	6-11	12-24
7.5' Kit w/ Value Spike	191730	147.10	142.70	138.30	133.90	191732	232.20	225.30	218.30	211.30
7.5' Kit w/ Cross Base and Water Ballast	191731	204.30	198.20	192.10	185.90	191733	289.50	280.75	272.00	263.50
10.5' Kit w/ Value Spike	191736	174.50	169.30	164.00	158.80	191738	274.00	265.75	257.50	249.30
10.5' Kit w/ Cross Base and Water Ballast	191737	231.70	224.80	217.80	210.90	191739	331.25	321.25	311.25	301.50
15' Kit w/ Value Spike	191742	230.70	223.80	216.80	209.90	191744	373.75	362.75	351.50	340.25
15' Kit w/ Cross Base and Water Ballast	191743	288.00	279.25	270.75	262.00	191745	431.00	418.25	405.25	392.25

**Setup fee: \$20(G)**

Kit Includes: Hardware with Specified Base and Graphic (Does not include carry case)

Description	Product Size w/Spike	Product Size w/Cross Base	Finished Graphic Size	Product Wt. (Spike / Cross)	Media (Single / Double)
7.5'	28.5"W x 88.25"H x 1.5"D	43.5"W x 91.625"H x 23.75"D	view online template	3 lbs. / 4.3 lbs.	super poly knit fabric / block-out polyester
10.5'	30.25"W x 124"H x 1.5"D	45.25"W x 127.375"H x 23.75"D	view online template	3.8 lbs. / 5.1 lbs.	super poly knit fabric / block-out polyester
15'	35.5"W x 177"H x 1.5"D	50.5"W x 180.375"H x 23.75"D	view online template	5.6 lbs. / 6.3 lbs.	super poly knit fabric / block-out polyester

**Pricing is subject to change.**

USD MSRP (C)



**Value Razor Sail Sign**

Description	Item #	Single-Sided Flag				Double-Sided Flag				
		1	2-5	6-11	12-24	Item #	1	2-5	6-11	12-24
7.5' Kit w/ Value Spike	191650	147.10	142.70	138.30	133.90	191652	232.10	225.10	218.10	211.20
7.5' Kit w/ Cross Base and Water Ballast	191651	204.30	198.20	192.10	185.90	191653	289.25	280.50	272.00	263.25
10.5' Kit w/ Value Spike	191658	174.50	169.30	164.00	158.80	191660	274.00	265.75	257.50	249.30
10.5' Kit w/ Cross Base and Water Ballast	191659	231.70	224.80	217.80	210.90	191661	331.25	321.25	311.25	301.50
15' Kit w/ Value Spike	191666	230.70	223.80	216.80	209.90	191668	373.75	362.75	351.50	340.25
15' Kit w/ Cross Base and Water Ballast	191667	288.00	279.25	270.75	262.00	191669	431.00	418.25	405.25	392.25

**Setup fee: \$20(G)**

Kit Includes: Hardware with Specified Base and Graphic (Does not include carry case)

Description	Product Size w/Spike	Product Size w/Cross Base	Finished Graphic Size	Product Wt. (Spike / Cross)	Media (Single / Double)
7.5'	28.5"W x 88.25"H x 1.5"D	43.5"W x 91.625"H x 23.75"D	view online template	3 lbs. / 4.3 lbs.	super poly knit fabric / block-out polyester
10.5'	30.25"W x 124"H x 1.5"D	45.25"W x 127.375"H x 23.75"D	view online template	3.8 lbs. / 5.1 lbs.	super poly knit fabric / block-out polyester
15'	35.5"W x 177"H x 1.5"D	50.5"W x 180.375"H x 23.75"D	view online template	5.6 lbs. / 6.3 lbs.	super poly knit fabric / block-out polyester

**Pricing is subject to change.**

USD MSRP (C)

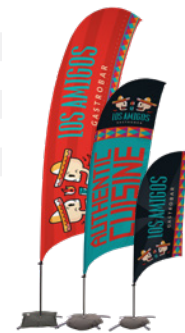

**Value Teardrop Sail Sign**

Description	Item #	Single-Sided Flag				Double-Sided Flag				
		1	2-5	6-11	12-24	Item #	1	2-5	6-11	12-24
6.5' Kit w/ Value Spike	191610	147.10	142.70	138.30	133.90	191612	232.10	225.10	218.10	211.20
6.5' Kit w/ Cross Base and Water Ballast	191611	204.30	198.20	192.10	185.90	191613	289.25	280.50	272.00	263.25
9.5' Kit w/ Value Spike	191618	174.50	169.30	164.00	158.80	191620	274.00	265.75	257.50	249.30
9.5' Kit w/ Cross Base and Water Ballast	191619	231.70	224.80	217.80	210.90	191621	331.25	321.25	311.25	301.50
13' Kit w/ Value Spike	191626	230.70	223.80	216.80	209.90	191628	373.75	362.75	351.50	340.25
13' Kit w/ Cross Base and Water Ballast	191627	288.00	279.25	270.75	262.00	191629	431.00	418.25	405.25	392.25

**Setup fee: \$20(G)**

Kit Includes: Hardware with Specified Base and Graphic (Does not include carry case)

Description	Product Size w/Spike	Product Size w/Cross Base	Finished Graphic Size	Product Wt. (Spike / Cross)	Media (Single / Double)
6.5'	34.25"W x 78.5"H x 1.5"D	49.25"W x 81.875"H x 23.75"D	view online template	2.8 lbs. / 4.1 lbs.	super poly knit fabric / block-out polyester
9.5'	44.25"W x 112.5"H x 1.5"D	59.25"W x 115.875"H x 23.75"D	view online template	3.4 lbs. / 4.7 lbs.	super poly knit fabric / block-out polyester
13'	51.5"W x 154"H x 1.5"D	66.5"W x 157.375"H x 23.75"D	view online template	5 lbs. / 5.7 lbs.	super poly knit fabric / block-out polyester

**Pricing is subject to change.**

USD MSRP (C)



**Add-Ons**

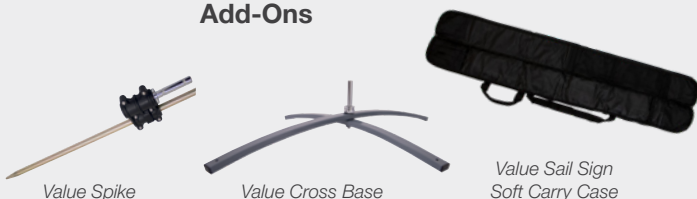

**Value Sail Sign Bases and Optional Carry Case**

Item #	Description	Product Wt.	1	2-5	6-11	12-24
191590	Value Spike	2 lbs.	37.40	36.28	35.16	34.03
191591	Value Cross Base	2.8 lbs.	37.40	36.28	35.16	34.03
220351	Value Soft Carry Case	0.8 lb.	23.55	22.84	22.14	21.43

**Pricing is subject to change.**

USD MSRP (C)

## STREAMLINE SAIL SIGN



Streamline sail signs provide the largest artwork surface area with its integrated printed pole pocket.

- Sizes range from 6' to 17' tall
- Carbon composite poles are strong and flexible
- Artwork is dye sublimated on super poly knit fabric for single-sided sail signs and on block-out polyester for double-sided sail signs
- Flags used outdoors have a 90-day warranty; flags used indoors have a 1-year warranty
- Lifetime warranty on pole hardware

### Single- or Double-Sided



#### Single-Sided

Image printed on one side; reverse image shows through back.



#### Double-Sided

Image printed correctly on both sides using a block-out polyester.



7' Blade    10' Rectangle    13' Razor    15' Teardrop    14.5' Rectangle    13' Blade    9' Razor    6' Teardrop



14.5', 15' and 17' double-sided spike kits include the Ground Anchor spike; attach to Ground spike for additional stability.

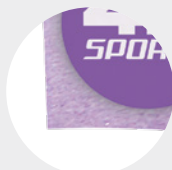

Double-sided flags feature a lightweight block-out polyester for increased flyability.



Uniform carbon composite overlay construction with high-gloss black paint finish.

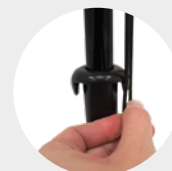

Flag attaches to a fixed hook using a bungee cord.



Pole pocket is made of the same fabric as the flag.

### Durable Construction

### Streamline Blade Sail Sign

Description	Item #	Single-Sided Flag				Double-Sided Flag				
		1	2-5	6-11	12-24	Item #	1	2-5	6-11	12-24
7' Kit w/ Ground Spike	191490	248.80	241.30	233.80	226.40	191492	360.75	349.75	339.00	328.25
7' Kit w/ Three-Legged Base and Water Ballast	191491	290.75	282.00	273.25	264.50	191493	402.50	390.50	378.50	366.50
9' Kit w/ Ground Spike	191496	280.00	271.50	263.25	254.75	191498	409.25	397.00	384.75	372.50
9' Kit w/ Scissor Base and Water Ballast	191497	368.50	357.50	346.50	335.25	191499	498.00	483.00	468.00	453.00
13' Kit w/ Ground Spike	191502	346.25	335.75	325.50	315.00	191504	530.50	514.50	498.50	482.75
13' Kit w/ Scissor Base and Water Ballast	191503	434.75	421.75	408.50	395.50	191505	619.00	600.50	582.00	563.00
17' Kit w/ Ground Spike	191508	425.75	413.00	400.25	387.50	191510	658.50	639.00	619.00	599.50
17' Kit w/ Scissor Base and Water Ballast	191509	514.50	498.75	483.50	468.00	191511	747.00	724.50	702.50	680.00

**Setup fee: \$20(G)**

Kit Includes: Hardware with Specified Base, Graphic and Soft Carry Case

**Pricing is subject to change.**

USD MSRP (C)

Description	Product Size w/ Ground Spike	Product Size w/ Scissor Base	Finished Graphic Size	Product Wt. (Spike / Scissor)	Media (Single / Double)
7'	19.75"W x 81.5"H x 2"D	28.375"W x 83.5"H x 15.25"D	view online template	3 lbs. / 2.75 lbs.	super poly knit fabric / block-out polyester
9'	29"W x 106"H x 2"D	40.5"W x 108"H x 23"D	view online template	4.75 lbs. / 10.25 lbs.	super poly knit fabric / block-out polyester
13'	32"W x 151"H x 2"D	43.5"W x 153"H x 23"D	view online template	6.75 lbs. / 10.75 lbs.	super poly knit fabric / block-out polyester
17'	36"W x 205"H x 2"D	47.5"W x 207"H x 23"D	view online template	9.4 lbs. / 14.25 lbs.	super poly knit fabric / block-out polyester



### Streamline Razor Sail Sign

Description	Item #	Single-Sided Flag				Double-Sided Flag				
		1	2-5	6-11	12-24	Item #	1	2-5	6-11	12-24
7' Kit w/ Ground Spike	191428	248.80	241.30	233.80	226.40	191436	360.75	349.75	339.00	328.25
7' Kit w/ Three-Legged Base and Water Ballast	191429	290.75	282.00	273.25	264.50	191437	402.50	390.50	378.50	366.50
9' Kit w/ Ground Spike	191430	280.00	271.50	263.25	254.75	191438	409.25	397.00	384.75	372.50
9' Kit w/ Scissor Base and Water Ballast	191431	368.50	357.50	346.50	335.25	191439	498.00	483.00	468.00	453.00
13' Kit w/ Ground Spike	191432	346.25	335.75	325.50	315.00	191440	530.50	514.50	498.50	482.75
13' Kit w/ Scissor Base and Water Ballast	191433	434.75	421.75	408.50	395.50	191441	619.00	600.50	582.00	563.00
17' Kit w/ Ground Spike	191434	425.75	413.00	400.25	387.50	191442	658.50	639.00	619.00	599.50
17' Kit w/ Scissor Base and Water Ballast	191435	514.50	498.75	483.50	468.00	191443	747.00	724.50	702.50	680.00

**Setup fee: \$20(G)**

Kit Includes: Hardware with Specified Base, Graphic and Soft Carry Case

**Pricing is subject to change.**

USD MSRP (C)

Description	Product Size w/ Ground Spike	Product Size w/ Scissor Base	Finished Graphic Size	Product Wt. (Spike / Scissor)	Media (Single / Double)
7'	19.75"W x 81.5"H x 2"D	28.375"W x 83.5"H x 15.25"D	view online template	3 lbs. / 2.75 lbs.	super poly knit fabric / block-out polyester
9'	29"W x 106"H x 2"D	40.5"W x 108"H x 22.75"D	view online template	4.75 lbs. / 10.25 lbs.	super poly knit fabric / block-out polyester
13'	32"W x 151"H x 2"D	43.5"W x 153"H x 22.75"D	view online template	6.75 lbs. / 12.25 lbs.	super poly knit fabric / block-out polyester
17'	36"W x 205"H x 2"D	47.5"W x 207"H x 22.75"D	view online template	9.4 lbs. / 14.25 lbs.	super poly knit fabric / block-out polyester



### Streamline Teardrop Sail Sign

Description	Item #	Single-Sided Flag				Double-Sided Flag				
		1	2-5	6-11	12-24	Item #	1	2-5	6-11	12-24
6' Kit w/ Ground Spike	191400	248.80	241.30	233.80	226.40	191408	360.75	349.75	339.00	328.25
6' Kit w/ Three-Legged Base and Water Ballast	191401	290.75	282.00	273.25	264.50	191409	402.50	390.50	378.50	366.50
8' Kit w/ Ground Spike	191402	280.00	271.50	263.25	254.75	191410	409.25	397.00	384.75	372.50
8' Kit w/ Scissor Base and Water Ballast	191403	368.50	357.50	346.50	335.25	191411	498.00	483.00	468.00	453.00
11.5' Kit w/ Ground Spike	191404	346.25	335.75	325.50	315.00	191412	530.50	514.50	498.50	482.75
11.5' Kit w/ Scissor Base and Water Ballast	191405	434.75	421.75	408.50	395.50	191413	619.00	600.50	582.00	563.00
15' Kit w/ Ground Spike	191406	425.75	413.00	400.25	387.50	191414	658.50	639.00	619.00	599.50
15' Kit w/ Scissor Base and Water Ballast	191407	514.50	498.75	483.50	468.00	191415	747.00	724.50	702.50	680.00

**Setup fee: \$20(G)**

Kit Includes: Hardware with Specified Base, Graphic and Soft Carry Case

**Pricing is subject to change.**

USD MSRP (C)

Description	Product Size w/ Ground Spike	Product Size w/ Scissor Base	Finished Graphic Size	Product Wt. (Spike / Scissor)	Media (Single / Double)
6'	23.25"W x 72.5"H x 2"D	31.875"W x 74.5"H x 15.25"D	view online template	2.75 lbs. / 2.5 lbs.	super poly knit fabric / block-out polyester
8'	30.5"W x 91.5"H x 2"D	42"W x 93.5"H x 22.75"D	view online template	4.75 lbs. / 10.25 lbs.	super poly knit fabric / block-out polyester
11.5'	36"W x 144.5"H x 2"D	47.5"W x 146.5"H x 22.75"D	view online template	7.25 lbs. / 12.75 lbs.	super poly knit fabric / block-out polyester
15'	40"W x 194.5"H x 2"D	51.5"W x 196.5"H x 22.75"D	view online template	10.4 lbs. / 15.25 lbs.	super poly knit fabric / block-out polyester



### Streamline Rectangle Sail Sign

Description	Item #	Single-Sided Flag				Double-Sided Flag				
		1	2-5	6-11	12-24	Item #	1	2-5	6-11	12-24
7' Kit w/ Ground Spike	191416	280.00	271.50	263.25	254.75	191422	409.25	397.00	384.75	372.50
7' Kit w/ Scissor Base and Water Ballast	191417	368.50	357.50	346.50	335.25	191423	498.00	483.00	468.00	453.00
10' Kit w/ Ground Spike	191418	346.25	335.75	325.50	315.00	191424	530.50	514.50	498.50	482.75
10' Kit w/ Scissor Base and Water Ballast	191419	434.75	421.75	408.50	395.50	191425	619.00	600.50	582.00	563.00
14.5' Kit w/ Ground Spike	191420	425.75	413.00	400.25	387.50	191426	658.50	639.00	619.00	599.50
14.5' Kit w/ Scissor Base and Water Ballast	191421	514.50	498.75	483.50	468.00	191427	747.00	724.50	702.50	680.00

**Setup fee: \$20(G)**

Kit Includes: Hardware with Specified Base, Graphic and Soft Carry Case

**Pricing is subject to change.**

USD MSRP (C)

Description	Product Size w/ Ground Spike	Product Size w/ Scissor Base	Finished Graphic Size	Product Wt. (Spike / Scissor)	Media (Single / Double)
7'	31.5"W x 85.5"H x 2"D	43"W x 87.5"H x 22.75"D	view online template	5 lbs. / 10.25 lbs.	super poly knit fabric / block-out polyester
10'	31.5"W x 117"H x 2"D	43"W x 119"H x 22.75"D	view online template	6.25 lbs. / 11.75 lbs.	super poly knit fabric / block-out polyester
14.5'	31.5"W x 171.5"H x 2"D	43"W x 173.5"H x 22.75"D	view online template	8.4 lbs. / 13.25 lbs.	super poly knit fabric / block-out polyester



**PRICES ARE SUBJECT TO CHANGE.** No setup fee on orders placed via our website. Visit [showdowndisplays.com](http://showdowndisplays.com) for current pricing, graphic templates, product videos and assembly instructions. See pages 288-291 for order details.

SHOWDOWNDISPLAYS.COM · ASI 87188 · PPAI 254687 · SAGE 67383 · PPPC 20101202

production lead time  
after final proof approval  
**2DAYS**

## PREMIUM SAIL SIGN



Premium sail signs are reinforced with black pole pockets constructed of high tensile strength elastic polyester binding.

- Sizes range from 6' to 17' tall
- Carbon composite poles are strong and flexible
- Artwork is dye sublimated on super poly knit fabric for single-sided sail signs and on block-out polyester for double-sided sail signs
- Flags used outdoors have a 90-day warranty; flags used indoors have a 1-year warranty
- Lifetime warranty on pole hardware



7' Blade    10' Rectangle    13' Razor    17' Blade    15' Teardrop    14.5' Rectangle    9' Razor    6' Teardrop

### Single- or Double-Sided



#### Single-Sided

Image printed on one side; reverse image shows through back.



#### Double-Sided

Image printed correctly on both sides using a block-out polyester.



14.5', 15' and 17' double-sided spike kits include the Ground Anchor spike; attach to Ground spike for additional stability.

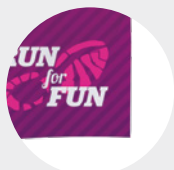

Double-sided flags feature a lightweight block-out polyester for increased flyability.



Uniform carbon composite overlay construction with high-gloss black paint finish.

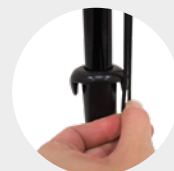

Flag attaches to a fixed hook using a bungee cord.

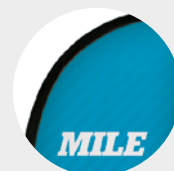

Pole pocket is made of high tensile strength elastic polyester binding.

### Durable Construction

**Premium Blade Sail Sign**

Description	Item #	Single-Sided Flag				Double-Sided Flag				
		1	2-5	6-11	12-24	Item #	1	2-5	6-11	12-24
7' Kit w/ Ground Spike	191515	284.25	275.75	267.25	258.50	191517	432.75	419.75	406.75	393.75
7' Kit w/ Three-Legged Base and Water Ballast	191516	326.25	316.50	306.50	296.75	191518	474.50	460.25	446.25	432.00
9' Kit w/ Ground Spike	191521	315.25	305.75	296.50	287.00	191523	480.00	465.75	451.25	437.00
9' Kit w/ Scissor Base and Water Ballast	191522	403.75	391.75	379.50	367.50	191524	568.50	551.50	534.50	517.50
13' Kit w/ Ground Spike	191527	383.50	372.00	360.50	349.00	191529	605.00	587.00	569.00	550.50
13' Kit w/ Scissor Base and Water Ballast	191528	472.00	458.00	443.75	429.50	191530	693.50	673.00	652.00	631.50
17' Kit w/ Ground Spike	191533	459.25	445.50	431.75	417.75	191535	729.00	707.00	685.50	663.50
17' Kit w/ Scissor Base and Water Ballast	191534	547.50	531.50	515.00	498.50	191536	817.50	793.00	768.50	744.00

**Setup fee: \$20(G)**

Kit Includes: Hardware with Specified Base, Graphic and Soft Carry Case

**Pricing is subject to change.**

USD MSRP (C)

Description	Product Size w/ Ground Spike	Product Size w/ Scissor Base	Finished Graphic Size	Product Wt. (Spike / Scissor)	Media (Single / Double)
7'	19.75"W x 81.5"H x 2"D	28.375"W x 83.5"H x 15.25"D	view online template	3.25 lbs. / 3 lbs.	super poly knit fabric / block-out polyester
9'	29"W x 106"H x 2"D	40.5"W x 108"H x 23"D	view online template	5 lbs. / 10.5 lbs.	super poly knit fabric / block-out polyester
13'	32"W x 151"H x 2"D	43.5"W x 153"H x 23"D	view online template	7 lbs. / 12.5 lbs.	super poly knit fabric / block-out polyester
17'	36"W x 205"H x 2"D	47.5"W x 207"H x 23"D	view online template	9.6 lbs. / 14.5 lbs.	super poly knit fabric / block-out polyester



**Premium Razor Sail Sign**

Description	Item #	Single-Sided Flag				Double-Sided Flag				
		1	2-5	6-11	12-24	Item #	1	2-5	6-11	12-24
7' Kit w/ Ground Spike	190982	284.25	275.75	267.25	258.50	190980	432.75	419.75	406.75	393.75
7' Kit w/ Three-Legged Base and Water Ballast	190985	326.25	316.50	306.50	296.75	190984	474.50	460.25	446.25	432.00
9' Kit w/ Ground Spike	190667	315.25	305.75	296.50	287.00	190665	480.00	465.75	451.25	437.00
9' Kit w/ Scissor Base and Water Ballast	190757	403.75	391.75	379.50	367.50	190756	568.50	551.50	534.50	517.50
13' Kit w/ Ground Spike	190672	383.50	372.00	360.50	349.00	190670	605.00	587.00	569.00	550.50
13' Kit w/ Scissor Base and Water Ballast	190759	472.00	458.00	443.75	429.50	190758	693.50	673.00	652.00	631.50
17' Kit w/ Ground Spike	190677	459.25	445.50	431.75	417.75	190675	729.00	707.00	685.50	663.50
17' Kit w/ Scissor Base and Water Ballast	190761	547.50	531.50	515.00	498.50	190760	817.50	793.00	768.50	744.00

**Setup fee: \$20(G)**

Kit Includes: Hardware with Specified Base, Graphic and Soft Carry Case

**Pricing is subject to change.**

USD MSRP (C)

Description	Product Size w/ Ground Spike	Product Size w/ Scissor Base	Finished Graphic Size	Product Wt. (Spike / Scissor)	Media (Single / Double)
7'	19.75"W x 81.5"H x 2"D	28.375"W x 83.5"H x 15.25"D	view online template	3.25 lbs. / 3 lbs.	super poly knit fabric / block-out polyester
9'	29"W x 106"H x 2"D	40.5"W x 108"H x 22.75"D	view online template	5 lbs. / 10.5 lbs.	super poly knit fabric / block-out polyester
13'	32"W x 151"H x 2"D	43.5"W x 153"H x 22.75"D	view online template	7 lbs. / 12.5 lbs.	super poly knit fabric / block-out polyester
17'	36"W x 205"H x 2"D	47.5"W x 207"H x 22.75"D	view online template	9.6 lbs. / 14.5 lbs.	super poly knit fabric / block-out polyester



**Premium Teardrop Sail Sign**

Description	Item #	Single-Sided Flag				Double-Sided Flag				
		1	2-5	6-11	12-24	Item #	1	2-5	6-11	12-24
6' Kit w/ Ground Spike	190976	284.25	275.75	267.25	258.50	190974	432.75	419.75	406.75	393.75
6' Kit w/ Three-Legged Base and Water Ballast	190979	326.25	316.50	306.50	296.75	190978	474.50	460.25	446.25	432.00
8' Kit w/ Ground Spike	190682	315.25	305.75	296.50	287.00	190680	480.00	465.75	451.25	437.00
8' Kit w/ Scissor Base and Water Ballast	190763	403.75	391.75	379.50	367.50	190762	568.50	551.50	534.50	517.50
11.5' Kit w/ Ground Spike	190687	383.50	372.00	360.50	349.00	190685	605.00	587.00	569.00	550.50
11.5' Kit w/ Scissor Base and Water Ballast	190765	472.00	458.00	443.75	429.50	190764	693.50	673.00	652.00	631.50
15' Kit w/ Ground Spike	190692	459.25	445.50	431.75	417.75	190690	729.00	707.00	685.50	663.50
15' Kit w/ Scissor Base and Water Ballast	190767	547.50	531.50	515.00	498.50	190766	817.50	793.00	768.50	744.00

**Setup fee: \$20(G)**

Kit Includes: Hardware with Specified Base, Graphic and Soft Carry Case

**Pricing is subject to change.**

USD MSRP (C)

Description	Product Size w/ Ground Spike	Product Size w/ Scissor Base	Finished Graphic Size	Product Wt. (Spike / Scissor)	Media (Single / Double)
6'	23.25"W x 72.5"H x 2"D	31.875"W x 74.5"H x 15.25"D	view online template	3 lbs. / 2.75 lbs.	super poly knit fabric / block-out polyester
8'	30.5"W x 91.5"H x 2"D	42"W x 93.5"H x 22.75"D	view online template	5 lbs. / 10.5 lbs.	super poly knit fabric / block-out polyester
11.5'	36"W x 144.5"H x 2"D	47.5"W x 146.5"H x 22.75"D	view online template	7.5 lbs. / 13 lbs.	super poly knit fabric / block-out polyester
15'	40"W x 194.5"H x 2"D	51.5"W x 196.5"H x 22.75"D	view online template	10.6 lbs. / 15.5 lbs.	super poly knit fabric / block-out polyester



**Premium Rectangle Sail Sign**

Description	Item #	Single-Sided Flag				Double-Sided Flag				
		1	2-5	6-11	12-24	Item #	1	2-5	6-11	12-24
7' Kit w/ Ground Spike	190652	315.25	305.75	296.50	287.00	190650	480.00	465.75	451.25	437.00
7' Kit w/ Scissor Base and Water Ballast	190751	403.75	391.75	379.50	367.50	190750	568.50	551.50	534.50	517.50
10' Kit w/ Ground Spike	190657	383.50	372.00	360.50	349.00	190655	605.00	587.00	569.00	550.50
10' Kit w/ Scissor Base and Water Ballast	190753	472.00	458.00	443.75	429.50	190752	693.50	673.00	652.00	631.50
14.5' Kit w/ Ground Spike	190662	459.25	445.50	431.75	417.75	190660	729.00	707.00	685.50	663.50
14.5' Kit w/ Scissor Base and Water Ballast	190755	547.50	531.50	515.00	498.50	190754	817.50	793.00	768.50	744.00

**Setup fee: \$20(G)**

Kit Includes: Hardware with Specified Base, Graphic and Soft Carry Case

**Pricing is subject to change.**

USD MSRP (C)

Description	Product Size w/ Ground Spike	Product Size w/ Scissor Base	Finished Graphic Size	Product Wt. (Spike / Scissor)	Media (Single / Double)
7'	31.5"W x 85.5"H x 2"D	43"W x 87.5"H x 22.75"D	view online template	5.25 lbs. / 10.5 lbs.	super poly knit fabric / block-out polyester
10'	31.5"W x 117"H x 2"D	43"W x 119"H x 22.75"D	view online template	6.5 lbs. / 12 lbs.	super poly knit fabric / block-out polyester
14.5'	31.5"W x 171.5"H x 2"D	43"W x 173.5"H x 22.75"D	view online template	8.6 lbs. / 13.5 lbs.	super poly knit fabric / block-out polyester



## ELITE SAIL SIGN



Elite sail signs showcase brilliant colors and a long-lasting UV life making them exceptional for extended use.

- Sizes range from 6' to 17' tall
- Constructed of 200 denier nylon
- Available in single-sided only
- Carbon composite poles are strong and flexible
- Flags used outdoor have a 6-month warranty; flags used indoors have a 2-year warranty
- Lifetime warranty on pole hardware
- Not eligible for Rush Service

### Single-Sided

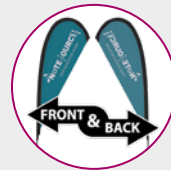

### Single-Sided

Image printed on one side; reverse image shows through back.



8' Teardrop

13' Razor

17' Blade

15' Teardrop

9' Razor

7' Blade



### Durable Construction



Uniform carbon composite overlay construction with high-gloss black paint finish.

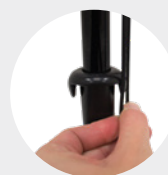

Flag attaches to a fixed hook using a bungee cord.

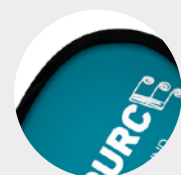

Pole pocket is made of high-tensile strength elastic polyester binding.



### Elite Blade Sail Sign

Item #	Description	1	2-5	6-11	12-24
191800	7' Kit w/ Ground Spike	291.50	282.75	274.00	265.25
191801	7' Kit w/ Three-Legged Base and Water Ballast	333.50	323.50	313.50	303.50
191802	9' Kit w/ Ground Spike	323.50	313.75	304.25	294.50
191803	9' Kit w/ Scissor Base and Water Ballast	412.00	399.75	387.25	375.00
191804	13' Kit w/ Ground Spike	394.50	382.75	370.75	359.00
191805	13' Kit w/ Scissor Base and Water Ballast	483.00	468.50	454.00	439.50
191806	17' Kit w/ Ground Spike	472.50	458.25	444.00	430.00
191807	17' Kit w/ Scissor Base and Water Ballast	561.00	544.00	527.50	510.50

**Setup fee: \$20(G)**

Kit Includes: Hardware with Specified Base, Graphic and Soft Carry Case

**Pricing is subject to change.**

USD MSRP (C)

Description	Product Size w/ Ground Spike	Product Size w/ Scissor Base	Finished Graphic Size	Product Wt. (Spike / Scissor)	Media
7'	19.75"W x 81.5"H x 2"D	28.375"W x 83.5"H x 15.25"D	view online template	3 lbs. / 2.75 lbs.	200 denier nylon
9'	29"W x 106"H x 2"D	40.5"W x 108"H x 23"D	view online template	4.5 lbs. / 10 lbs.	200 denier nylon
13'	32"W x 151"H x 2"D	43.5"W x 153"H x 23"D	view online template	6 lbs. / 11 lbs.	200 denier nylon
17'	36"W x 205"H x 2"D	47.5"W x 207"H x 23"D	view online template	7 lbs. / 12 lbs.	200 denier nylon



### Elite Razor Sail Sign

Item #	Description	1	2-5	6-11	12-24
191812	7' Kit w/ Ground Spike	291.75	283.00	274.25	265.50
191813	7' Kit w/ Three-Legged Base and Water Ballast	333.75	323.75	313.50	303.50
191814	9' Kit w/ Ground Spike	323.75	314.00	304.25	294.50
191815	9' Kit w/ Scissor Base and Water Ballast	412.25	399.75	387.50	375.00
191816	13' Kit w/ Ground Spike	394.50	382.75	370.75	359.00
191817	13' Kit w/ Scissor Base and Water Ballast	483.00	468.50	454.00	439.50
191818	17' Kit w/ Ground Spike	472.50	458.25	444.00	430.00
191819	17' Kit w/ Scissor Base and Water Ballast	561.00	544.00	527.50	510.50

**Setup fee: \$20(G)**

Kit Includes: Hardware with Specified Base, Graphic and Soft Carry Case

**Pricing is subject to change.**

USD MSRP (C)

Description	Product Size w/ Ground Spike	Product Size w/ Scissor Base	Finished Graphic Size	Product Wt. (Spike / Scissor)	Media
7'	19.75"W x 81.5"H x 2"D	28.375"W x 83.5"H x 15.25"D	view online template	3 lbs. / 2.75 lbs.	200 denier nylon
9'	29"W x 106"H x 2"D	40.5"W x 108"H x 23"D	view online template	4.5 lbs. / 10 lbs.	200 denier nylon
13'	32"W x 151"H x 2"D	43.5"W x 153"H x 23"D	view online template	6 lbs. / 11 lbs.	200 denier nylon
17'	36"W x 205"H x 2"D	47.5"W x 207"H x 23"D	view online template	7 lbs. / 12 lbs.	200 denier nylon



### Elite Teardrop Sail Sign

Item #	Description	1	2-5	6-11	12-24
191824	6' Kit w/ Ground Spike	291.75	283.00	274.25	265.50
191825	6' Kit w/ Three-Legged Base and Water Ballast	333.75	323.75	313.50	303.50
191826	8' Kit w/ Ground Spike	323.75	314.00	304.25	294.50
191827	8' Kit w/ Scissor Base and Water Ballast	412.25	399.75	387.50	375.00
191828	11.5' Kit w/ Ground Spike	394.50	382.75	370.75	359.00
191829	11.5' Kit w/ Scissor Base and Water Ballast	483.00	468.50	454.00	439.50
191830	15' Kit w/ Ground Spike	472.50	458.25	444.00	430.00
191831	15' Kit w/ Scissor Base and Water Ballast	561.00	544.00	527.50	510.50

**Setup fee: \$20(G)**

Kit Includes: Hardware with Specified Base, Graphic and Soft Carry Case

**Pricing is subject to change.**

USD MSRP (C)

Description	Product Size w/ Ground Spike	Product Size w/ Scissor Base	Finished Graphic Size	Product Wt. (Spike / Scissor)	Media
6'	23.25"W x 72.5"H x 2"D	31.875"W x 74.5"H x 15.25"D	view online template	3 lbs. / 2.75 lbs.	200 denier nylon
8'	30.5"W x 91.5"H x 2"D	42"W x 93.5"H x 22.75"D	view online template	5 lbs. / 10.5 lbs.	200 denier nylon
11.5'	36"W x 144.5"H x 2"D	47.5"W x 146.5"H x 22.75"D	view online template	7.5 lbs. / 13 lbs.	200 denier nylon
15'	40"W x 194.5"H x 2"D	51.5"W x 196.5"H x 22.75"D	view online template	10 lbs. / 15.5 lbs.	200 denier nylon



## ASCENT SAIL SIGN



Rise above the rest, at 22.5'H our tallest sail sign ensures your message is seen from a distance.

- Carbon composite poles are strong and flexible
- Two water ballasts and four stakes included for enhanced stability
- Water ballasts attach together and hold approximately 3 gallons of water each
- Optional base graphic available (sold separately)
- Artwork is dye sublimated on super poly knit fabric; optional base graphic is dye sublimated on two-way stretch fabric
- Flags used outdoors have a 90-day warranty; flags used indoors have a 1-year warranty
- Lifetime warranty on pole hardware



teardrop shown with optional base graphic

razor

blade

Base hardware folds down for easy transportability.

### Ascent Sail Sign

Item #	Description	1	2-5	6-11	12-24
191840	Blade Kit	654.50	635.00	615.00	595.50
191844	Razor Kit	654.50	635.00	615.00	595.50
191848	Teardrop Kit	654.50	635.00	615.00	595.50

**Setup fee: \$20(G)** **Pricing is subject to change.**  
Kit Includes: Hardware with Foldable Base, Graphic, 2 Water Ballasts, 4 Stakes and Soft Carry Case for Poles USD MSRP (C)

Description	Product Size	Finished Graphic Size	Product Wt.	Media
blade	54"W x 270"H x 29"D	view online template	14.8 lbs.	super poly knit fabric
razor	54"W x 270"H x 29"D	view online template	14.8 lbs.	super poly knit fabric
teardrop	63.75"W x 264"H x 29"D	view online template	14.4 lbs.	super poly knit fabric
base graphic	NA	view online template	0.5 lb.	two-way stretch fabric

### Ascent Sail Sign Optional Base Graphic

Item #	Description	1	2-5	6-11	12-24
191852	Optional Base Graphic	110.00	106.70	103.40	100.10

**Setup fee: \$20(G)** **Pricing is subject to change.**  
USD MSRP (C)

## MINI TEARDROP SAIL SIGN



This small, versatile flag is a creative option for advertising or showing off team spirit.

- Four hardware attachment styles available; hardware-only options available online
- Artwork is dye sublimated on super poly knit fabric for single-sided sail signs and on block-out polyester for double-sided sail signs
- Minimum order quantity of three
- Flags used outdoors have a 90-day warranty; flags used indoors have a 1-year warranty

### Mini Teardrop Sail Sign

Item #	Description	3-5	6-11	12-24	25-49
191380	Vehicle Single-Sided Kit	48.85	47.44	46.46	44.85
191381	Vehicle Double-Sided Kit	83.30	81.20	79.55	76.90
191382	Clip-On Single-Sided Kit	47.40	46.06	45.12	43.56
191383	Clip-On Double-Sided Kit	81.85	79.85	78.20	75.60
191384	Suction Cup Single-Sided Kit	53.15	51.50	50.45	48.67
191385	Suction Cup Double-Sided Kit	87.60	85.30	83.55	80.70
191391	Magnet Single-Sided Kit	56.05	54.30	53.15	51.25
191392	Magnet Double-Sided Kit	90.50	88.05	86.25	83.30

**Setup fee: \$20(G)** **Pricing is subject to change.**  
Kit Includes: Specified Hardware and Graphic Minimum order quantity of 3. USD MSRP (C)

Description	Product Size	Finished Graphic Size	Product Wt.	Media (Single / Double)
vehicle	15.5"W x 25.875"H x 2.875"D	view online template	4.1 oz.	super poly knit fabric / block-out polyester
clip-on	15.5"W x 26"H x 1.875"D	view online template	3.3 oz.	super poly knit fabric / block-out polyester
suction cup	17"W x 23.5"H x 3.5"D	view online template	5.1 oz.	super poly knit fabric / block-out polyester
magnet	14.25"W x 24.75"H x 2.75"D	view online template	8 oz.	super poly knit fabric / block-out polyester



Clip-On



Suction Cup



Vehicle



Magnetic

production lead time after final proof approval

**4 DAYS**

**PRICES ARE SUBJECT TO CHANGE.** No setup fee on orders placed via our website.

Visit [showdowndisplays.com](http://showdowndisplays.com) for current pricing, graphic templates, product videos and assembly instructions. See pages 288-291 for order details.

SHOWDOWNDISPLAYS.COM · ASI 87188 · PPAI 254687 · SAGE 67383 · PPPC 20101202

## SOLID-COLOR FLUTTER FLAG



The combination of movement and vibrant stock colors are an economical way to draw attention.

- Flag and pole pocket are constructed of 200 denier nylon
- 26 color options to choose from; 100% color on the front and back
- The stadium shape has rounded corners for a contoured look
- Flags have a 90-day warranty
- Not eligible for Rush Service

### Solid-Color Flutter Flag

Item #	Description	1	2-5	6-11	12-24
304780	10' Kit	204.90	188.50	176.20	163.90
304781	15' Kit	240.80	221.50	207.10	192.60
304782	18' Kit	271.25	249.70	233.40	217.10

Pricing is subject to change.

Kit Includes: Hardware with Spike Base, Graphic and Soft Carry Case

USD MSRP (C)

Description	Product Size	Product Wt.	Media
10'	30"W x 120"H x 2"D	3.7 lbs.	200 denier nylon
15'	30"W x 178.75"H x 2"D	5.5 lbs.	200 denier nylon
18'	30"W x 218.5"H x 2"D	6.6 lbs.	200 denier nylon



Pole pocket is made of the same fabric as the flag.

### Stock Flutter Flag Colors

- Bell Blue PMS 641
- French Blue PMS 285
- Pansy PMS 2617
- Black
- Gray PMS 7538
- Purple PMS 2695
- Buff PMS 141
- Irish Green PMS 349
- Royal Blue PMS 286
- Canada Red PMS 186
- Legion Blue PMS 2756
- Silver PMS 7534
- Charcoal PMS 424
- Maroon PMS 5115
- Spice Brown PMS 1545
- Daffodil PMS 108
- Mint Green PMS 360
- Spanish Yellow PMS 1235
- Dartmouth PMS 350
- UN Blue PMS 279
- OG Red PMS 187
- Orange PMS 172
- White
- FM Yellow PMS 106
- OG Red PMS 187

PMS colors are for reference only and may vary slightly from actual color.

## STADIUM FLUTTER FLAG



These flags are designed to flutter in the breeze.

- The stadium shape has rounded corners for a contoured look
- Available in 10', 15' and 18' sizes
- Flag and pole pocket are constructed of super poly knit fabric for single-sided flags and on block-out polyester for double-sided flags
- Flags have a 90-day warranty

### Stadium Flutter Flag

Item #	Description	1	2-5	6-11	12-24
304866	10' Single-Sided Kit	288.00	265.00	247.60	230.30
304867	10' Double-Sided Kit	426.50	392.50	366.75	341.25
304868	15' Single-Sided Kit	357.25	328.75	307.25	285.75
304869	15' Double-Sided Kit	551.00	507.00	474.00	441.00
304870	18' Single-Sided Kit	426.50	392.50	366.75	341.25
304871	18' Double-Sided Kit	675.50	621.50	581.00	540.50

Setup fee: \$20(G)

Pricing is subject to change.

Kit Includes: Hardware with Spike Base, Graphic and Soft Carry Case

USD MSRP (C)

Description	Product Size	Finished Graphic Size	Product Wt.	Media (Single / Double)
10'	30"W x 120"H x 2"D	view online template	6.2 lbs.	super poly knit fabric / block-out polyester
15'	30"W x 178.75"H x 2"D	view online template	8.5 lbs.	super poly knit fabric / block-out polyester
18'	30"W x 218.5"H x 2"D	view online template	10 lbs.	super poly knit fabric / block-out polyester



Double-sided flags feature a lightweight block-out polyester for increased flyability.



Carbon composite overlay construction with high-gloss black paint finish.

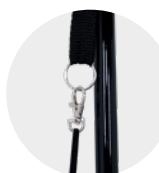

Flag attaches to a fixed hook using a bungee cord.



Pole pocket is made of the same fabric as the flag.

PRICES ARE SUBJECT TO CHANGE. No setup fee on orders placed via our website.

Visit [showdowndisplays.com](http://showdowndisplays.com) for current pricing, graphic templates, product videos and assembly instructions. See pages 288-291 for order details.

SHOWDOWNDISPLAYS.COM · ASI 87188 · PPAI 254687 · SAGE 67383 · PPPC 20101202

production lead time  
after final proof approval  
**4 DAYS**



**Item #190743**  
Wall mount  
(indoor/outdoor)



**Item #190744**  
Floor mount  
(indoor/outdoor)

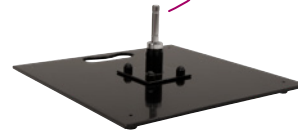

**Item #190746**  
Flat base  
(indoor/outdoor)



**Item #190699**  
Mount for fence posts  
for 6'-15' sail signs



**Item #190708**  
Round water ballast for  
6'-13' sail signs  
(indoor/outdoor)



**Item #190710**  
Square water ballast for  
14.5'-17' sail signs  
(indoor/outdoor)

## SAIL SIGN & FLUTTER FLAG ACCESSORIES



### Sail Sign & Flutter Flag Accessories

Item #	Description	Product Wt.	1	2-5	6-11	12-24
190746	Flat Base	21.8 lbs.	166.10	161.10	156.10	151.20
190744	Floor Mount	1.4 lbs.	47.07	45.66	44.25	42.83
190706	Ground Spike	2 lbs.	59.70	57.90	56.10	54.30
190748	Ground Spike Anchor	0.6 lb.	17.60	17.07	16.54	16.02
190711	Heavy-Duty Cross Base	9 lbs.	105.20	102.10	98.90	95.75
240522	Mount for Deluxe Tents	2 lbs.	47.23	46.29	45.34	43.92
240529	Mount for Elite Tents	2.6 lbs.	98.50	97.75	93.90	92.80
190699	Mount for Fence Posts	1.4 lbs.	48.44	46.99	45.53	44.08
240523	Mount for Premium / Gable Tents	2 lbs.	77.00	76.30	73.50	72.40
240521	Mount for Standard Tents	2 lbs.	45.71	44.80	43.88	42.51
190708	Round Water Ballast	0.5 lb.	57.20	55.50	53.80	52.05
190707	Scissor Base	7 lbs.	90.95	88.25	85.50	82.80
190747	Simple Spike*	1.4 lbs.	27.69	26.86	26.03	25.20
190710	Square Water Ballast	0.5 lb.	57.20	55.50	53.80	52.05
190714	Three-Legged Base	1.25 lbs.	44.43	43.10	41.76	40.43
220082	Universal Product Case	7 lbs.	171.90	166.70	161.50	156.40
191591	Value Cross Base*	2.8 lbs.	37.40	36.28	35.16	34.03
220351	Value Sail Sign Soft Carry Case	0.8 lb.	23.55	22.84	22.14	21.43
191590	Value Spike*	2 lbs.	37.40	36.28	35.16	34.03
190709	Vehicle Base	4.5 lbs.	90.95	88.25	85.50	82.80
190743	Wall Mount	1.6 lbs.	47.07	45.66	44.25	42.83

Pricing is subject to change.

USD MSRP (C)

\*Covered by a 90-day product warranty

when ordered before 2 pm central

**HARDWARE SHIPS  
SAME DAY**

**PRICES ARE SUBJECT TO CHANGE.** No setup fee on orders placed via our website. Visit [showdowndisplays.com](http://showdowndisplays.com) for current pricing, graphic templates, product videos and assembly instructions. See pages 288-291 for order details.

SHOWDOWNDISPLAYS.COM · ASI 87188 · PPAI 254687 · SAGE 67383 · PPPC 20101202

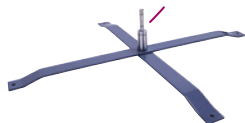

**Item #190711**  
Heavy-duty cross base  
(indoor/outdoor)



**Item #190709**  
Vehicle base  
(outdoor)



**Item #190707**  
Scissor base  
(indoor/outdoor)



**Item #190706**  
Ground spike  
(outdoor)



**Item #190714**  
Three-legged base for 6" Teardrop & 7" Razor/Blade (indoor)



**Item #191591**  
Value cross base  
(indoor/outdoor)\*



**Item #191590**  
Value spike  
(outdoor)\*

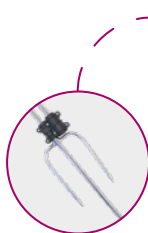

**Item #190748**  
Ground spike anchor (outdoor)

Requires a Ground, Value or Simple spike for use.



**Item #190747**  
Simple spike  
(outdoor)\*



**Item #220351**  
Value sail sign soft carry case



**Item #220082**  
Universal product case  
(holds up to three sail signs kits; excludes Ascent)



**Item #240522**  
Mount for Deluxe tents shown on a 10' Deluxe tent (sold separately); additional mount options available



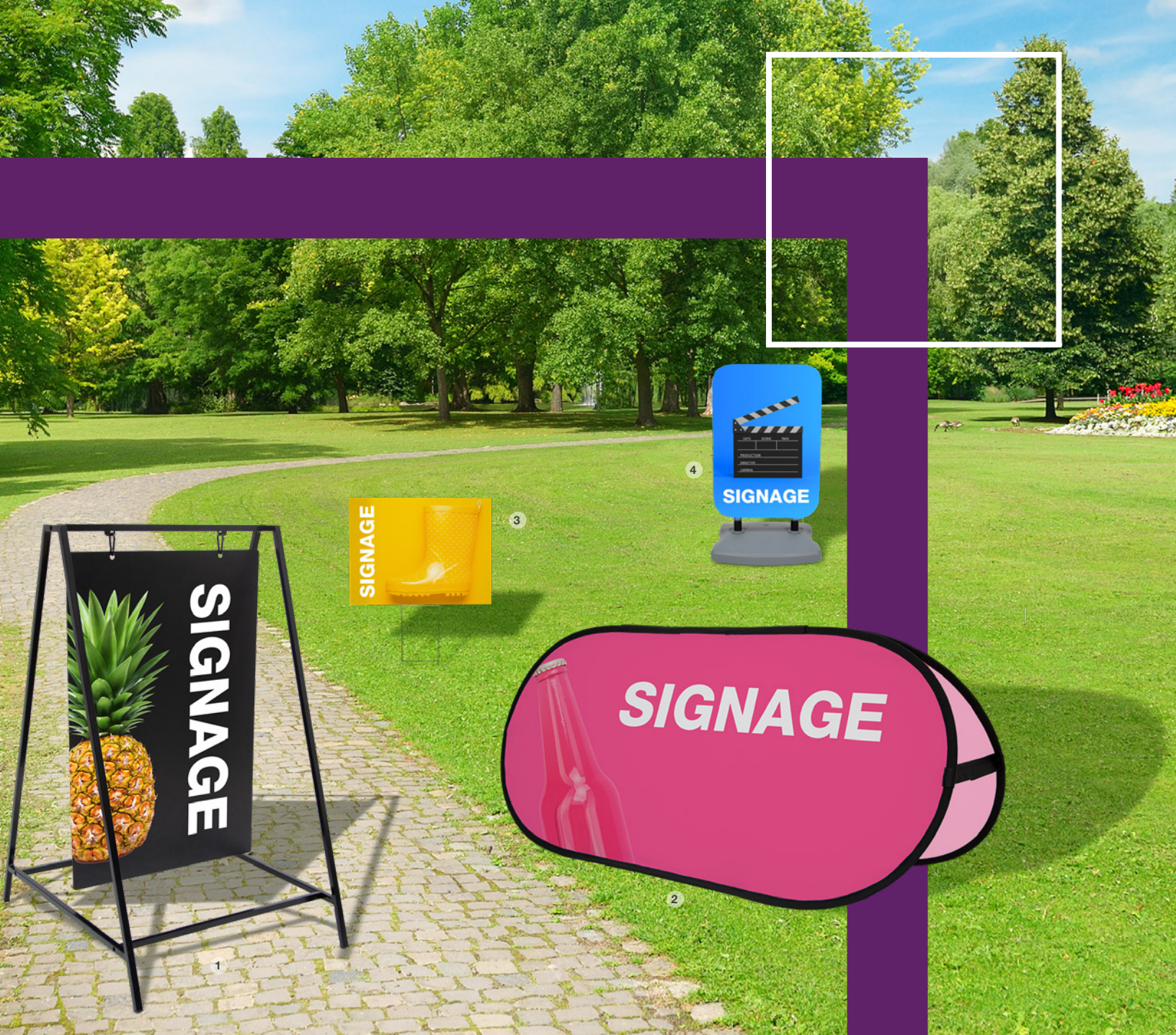

# SIGNAGE

1. Swing A-frame page 96 2. Twist-Up Oval A-frame page 99 3. Corrugated Plastic Sign page 100 4. EuroFit Flex Sign page 103

## have you considered...

- **location** will your sign be used indoors or outdoors?
- **longevity** how long will your sign be displayed?
- **flexibility** will your message be permanent or will it change frequently?
- **transport** will your sign be stationary or will you be transporting it from place to place?

## how to **DISPLAY**

Use signage to establish a strong presence. Incorporating signage throughout your business or event, including directional and informational signs, helps your customers navigate spaces easily and enhance their overall experience.

# SIGNAGE COMPARISON CHART

BEST SELLERS ★ SUSTAINABLE ◆		PG #	EASY CHANGE GRAPHIC	SINGLE- OR DOUBLE-SIDED		SUBSTRATE	OUTDOOR		WIND RATING	WEIGHT
OUTDOOR	SINGLE			DOUBLE	LONG TERM		SHORT TERM			
Coro A-Frame	◆	100		X		4 mm Corrugated Plastic		X	1-2	4 lbs.
Corrugated Plastic Sign	★◆	100		X	X	4 mm Corrugated Plastic	X		3-4	0.5-1.5 lbs.
Deluxe Wood A-Frame		95	✓		X	Chalkboard		X	2-3	17.8-29.8 lbs.
Economy Wood A-Frame		95	✓		X	Chalkboard		X	2-3	8.4 lbs.
EuroFit Flex Sign	◆	103	✓		X	Recycled Polyester Knit	X		3-4	14.8-15.7 lbs.
FrameWorx Flex		103	✓	X	X	Mesh Fabric		X	3-4	27.5 lbs.
Horizontal A-Frame		99	✓		X	Titan™ 13 oz. Scrim Vinyl	X		2-3	11-18 lbs.
Magnet Promo Sign		111		X		Magnet Media	X			0.4-1.6 lbs.
Menu Board A-Frame		95			X	Chalkboard		X	2-3	14 lbs.
Opaque Window Cling		111		X		Window Film	X			0.02-0.45 lb.
Outdoor Flex Sign		102	✓		X	Titan™ 10 oz. Scrim Vinyl	X		3-4	27 lbs.
Outdoor Flex Sign with Ballast Base		102	✓		X	Titan™ 10 oz. Scrim Vinyl	X		3-4	26 lbs.
Parking Pal		101			X	Reflective Media	X		4-5	13 lbs.
Rover Portable Sign Post		102	✓	X	X	Aluminum Composite	X		5-6	11.4-18 lbs.
Signicade A-Frame	★	94	✓		X	4 mm Corrugated Plastic	X		4-5	20 lbs.
Signicade Deluxe A-Frame	★	94	✓	X	X	4 mm Corrugated Plastic • Chalkboard	X		4-5	21-25 lbs.
Simpo Sign II A-Frame		94	✓	X	X	4 mm Corrugated Plastic	X		4-5	10.5 lbs.
Storm Mat		113		X		Polyester Carpeting with Rubber Backing	X			4-14 lbs.
Sunrise Lawn Sign		104	✓	X	X	Super Poly Knit Fabric • Block-Out Polyester	X		3-4	2.3 lbs.
Sunrise Multisurface Sign		104	✓	X	X	Super Poly Knit Fabric • Block-Out Polyester	X		3-4	13.5-14 lbs.
Superstrong Angle Iron A-Frame		98	✓		X	4 mm Corrugated Plastic	X		3-4	6.5-13.5 lbs.
Swing A-Frame		96	✓		X	Aluminum Composite • Chalkboard		X	2-3	14-16.2 lbs.
Twist-Up Oval A-Frame	◆	99			X	Recycled Polyester Knit	X		2-3	8.25 lbs.
Wayfinding Sign		101	✓		X	Aluminum Composite	X		6-7	1.2 lbs.
INDOOR		PG #		SINGLE	DOUBLE					
Adjustable Sign Display	◆	106	✓	X		3 mm Paperboard				7.4 lbs.
Aerial SEG	◆	110	✓		X	Recycled Polyester Knit				4.4-7.6 lbs.
Aerial SEG Glo		110	✓		X	Backlit Woven Polyester				5-10.2 lbs.
Flat Base Sign Display		107	✓		X	4 mm Corrugated Plastic				13.5 lbs.
Floor Decor		112		X		PVC Coated Polyester Woven Fabric w/ PVC Foam				1.6-22 lbs.
Floor Hugger Mat	★◆	113		X		Nylon Yarn with Rubber Backing				8-16 lbs.
Galleria A-Frame	◆	97	✓		X	Recycled Polyester Knit				6.8 lbs.
Impress Lite A-Frame	◆	98	✓		X	Recycled Polyester Knit				11 lbs.
Indoor Surface Grip		112		X		Adhesive Matte Vinyl with Fabric Backing				0.05-2.4 lbs.
Luxe Glo Sign		107		X		0.060 White Polycarbonate				3-6.6 lbs.
Standard Wall-Mount SEG Glo		109	✓	X		Backlit Woven Polyester				2.8-12.4 lbs.
Tower Tiles	◆	105			X	3 mm Paperboard				3.2-7.8 lbs.
Tower Trio	◆	105		X		4 mm Corrugated Plastic				6-8 lbs.
Uptown A-Frame		96	✓		X	Rigid PVC Board				15.5-24.25 lbs.
Uptown Accent A-Frame		97	✓		X	Rigid PVC Board				30.5 lbs.
Value Wall-Mount SEG	◆	108	✓	X		Recycled Polyester Knit				2.2-6 lbs.
Wayfinding Sign Post		106	✓		X	Aluminum Composite				13.6-15.2 lbs.



**Beaufort Wind Rating:** See rating icon underneath the product name. Wind ratings were determined utilizing all available securing/stabilizing options sold with or offered for the product. See page 291 for details.

## Signage Substrates



**Rigid**

- 4 mm Corrugated Plastic
- Rigid PVC Board
- Chalkboard
- Aluminum Composite
- 0.060 White Polycarbonate
- 3 mm Paperboard

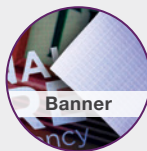

**Banner**

- Titan™ 10 oz. Scrim Vinyl
- Titan™ 13 oz. Scrim Vinyl

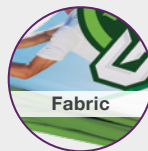

**Fabric**

- Super Poly Knit Fabric
- Recycled Polyester Knit
- Mesh Fabric
- Backlit Woven Polyester
- Block-Out Polyester

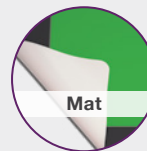

**Mat**

- PVC Coated Polyester Woven Fabric with PVC Foam
- Nylon Yarn with Rubber Backing
- Polyester Carpeting with Rubber Backing

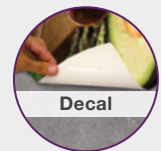

**Decal**

- Adhesive Matte Vinyl with Fabric Backing
- Window Film
- Magnet Media
- Reflective Media



## One Signboard, Two Sides.

Double-sided signboards have your artwork printed on both sides, making each signboard reversible.



Double-sided signboards available for Simpo Sign II and Signicade Deluxe

## SIGNICADE® AND SIMPO A-FRAMES



With multiple sizes to choose from, these A-frames fit a variety of spaces.

- Maintenance-free and weather-resistant
- Folds flat for easy transport or storage
- Signicade Deluxe available with signboards or chalkboard inserts
- Chalkboard inserts can be printed on for custom messaging



Chalk or chalk markers work in unimprinted areas only (chalk markers recommended; not included).

### Simpo Sign II A-Frame

Item #	Description	1	2-5	6-11	12-24
210091	Single-Sided Kit	232.10	224.90	214.50	207.30
271049	Single-Sided Signboard Only (1)	27.58	26.75	25.93	25.10
210092	Double-Sided Kit	248.90	241.70	230.20	223.10
271050	Double-Sided Signboard Only (1)	36.23	35.14	34.06	32.97

Setup fee: \$20(G)

Pricing is subject to change.

Kit Includes: Hardware and 2 Single- or Double-Sided Graphics

USD MSRP (C)

Product Size	Finished Graphic Size	Product Wt.	Media
24"W x 36.75"H x 21.5"D	view online template	10.5 lbs.	4 mm corrugated plastic

Frame Color  White

### Signicade Deluxe A-Frame

Item #	Description	1	2-5	6-11	12-24
210121	Single-Sided Kit	240.40	232.90	222.10	214.60
271072	Single-Sided Signboard Only (1)	27.58	26.75	25.93	25.10
210122	Double-Sided Kit	257.25	249.70	237.80	230.40
271073	Double-Sided Signboard Only (1)	36.23	35.14	34.06	32.97

Setup fee: \$20(G)

Pricing is subject to change.

Kit Includes: Black or White Hardware and 2 Single- or Double-Sided Graphics

USD MSRP (C)

Product Size	Finished Graphic Size	Product Wt.	Media
27"W x 38.5"H x 19"D	view online template	21 lbs.	4 mm corrugated plastic

Frame Colors  Black  White

### Signicade A-Frame

Item #	Description	1	2-5	6-11	12-24
210133	Kit	218.70	212.10	202.20	195.60
271084	Single-Sided Signboard Only (1)	27.58	26.75	25.93	25.10

Setup fee: \$20(G)

Pricing is subject to change.

Kit Includes: Orange, Yellow or White Hardware, 2 Single-Sided Graphics, 2 Strips of Hook and 2 Strips of Loop

USD MSRP (C)

Product Size	Finished Graphic Size	Product Wt.	Media
24.5"W x 42"H x 31"D	view online template	20 lbs.	4 mm corrugated plastic

Frame Colors  Orange PMS 2028  Yellow PMS 123  White

### Signicade Deluxe Chalkboard A-Frame

Item #	Description	1	2-5	6-11	12-24
264310	Imprinted Kit	533.50	526.00	497.00	489.50
264312	Imprinted Chalkboard Only (1)	89.30	86.60	83.90	81.25
210280	Unimprinted Kit	304.00	296.50	279.25	271.75
271098	Unimprinted Chalkboard Only (1)	61.00	58.55	56.10	53.70

Setup fee: \$20(G)

Pricing is subject to change.

Kit Includes: Black or White Hardware and 2 Unimprinted or Single-Sided Graphics

USD MSRP (C)

Product Size	Finished Graphic Size	Product Wt.	Media
27"W x 38.5"H x 19"D	view online template	25 lbs.	chalkboard laminated rigid PVC board

Frame Colors  Black  White

## Features & Benefits



Plastic base won't rust, making it great for outdoor use.



Convenient molded handle makes it easy to move.



Frames can be filled with water or sand for stability. (Sand only for Simpo II).



Signboards are easy to swap out to accommodate frequent message changes.

production lead time  
after final proof approval

# 2DAYS

UNIMPRINTED CHALKBOARD ONLY LEAD TIME: SHIPS SAME DAY WHEN ORDERED BEFORE 2 PM CENTRAL

PRICES ARE SUBJECT TO CHANGE. No setup fee on orders placed via our website.

Visit [showdowndisplays.com](http://showdowndisplays.com) for current pricing, graphic templates, product videos and assembly instructions. See pages 288-291 for order details.

SHOWDOWNDISPLAYS.COM · ASI 87188 · PPAI 254687 · SAGE 67383 · PPPC 20101202

## DELUXE AND ECONOMY WOOD A-FRAMES



These A-frames give you an upscale way to display daily specials, menu items, messages and creative artwork.

- Available in two colors; Deluxe is also available in two sizes
- Print artwork directly onto chalkboard to enhance your custom message
- Recommended for indoor or limited outdoor use
- Economy frame is made from pine wood; Deluxe frame is made from beech wood
- Wood A-frames used outdoors have a 30-day warranty; wood A-frames used indoors have a 1-year warranty

### Deluxe Wood Chalkboard A-Frame

Item #	Description	1	2-5	6-11	12-24
263520	32.5" Kit	263.00	256.00	243.60	236.50
263523	46" Kit	362.50	352.75	335.75	326.00

Setup fee: \$20(G)

Pricing is subject to change.

Kit Includes: Espresso or Light Brown Hardware and 2 Installed Single-Sided Graphics USD MSRP (C)

Description	Product Size	Finished Graphic Size	Product Wt.	Media
32.5"	21.625"W x 32.5"H x 19.125"D	view online template	17.8 lbs.	chalkboard
46"	26.75"W x 46"H x 24.375"D	view online template	29.8 lbs.	chalkboard

### Economy Wood Chalkboard A-Frame

Item #	Description	1	2-5	6-11	12-24
263530	Kit	220.40	215.10	204.40	199.00

Setup fee: \$20(G)

Pricing is subject to change.

Kit Includes: Espresso or Light Brown Hardware and 2 Installed Single-Sided Graphics USD MSRP (C)

Product Size	Finished Graphic Size	Product Wt.	Media
21.625"W x 32.5"H x 18.5"D	view online template	8.4 lbs.	chalkboard

Chalkboard inserts are constructed of polypropylene.



Deluxe 46" shown in light brown

Economy shown in espresso



A steel chain prevents the A-frame from opening all the way so it remains stable.



Metal hinges let you fold the frame flat for easy storage.



Imprinted chalkboard inserts slide into grooves in the top of the frame.



Chalk or chalk markers work in unimprinted areas only (chalk markers recommended; not included).

## MENU BOARD A-FRAME



This A-frame is a great option if you're looking for a chalkboard sign on a budget.

- Removable chalkboards are constructed of MDF
- Vibrant full-color imprint
- Chalk or chalk markers work in unimprinted areas only (chalk markers recommended; not included)
- Recommended for indoor or limited outdoor use

### Menu Board A-Frame

Item #	Description	1	2-5	6-11	12-24
AMB002	Kit	207.60	200.30	192.70	184.70

Setup fee: \$20(G)

Pricing is subject to change.

Kit Includes: Hardware and 2 Installed Single-Sided Graphics USD MSRP (C)

Product Size	Finished Graphic Size	Product Wt.	Media
24"W x 38"H x 26.5"D	view online template	14 lbs.	chalkboard



**PRICES ARE SUBJECT TO CHANGE.** No setup fee on orders placed via our website. Visit [showdowndisplays.com](http://showdowndisplays.com) for current pricing, graphic templates, product videos and assembly instructions. See pages 288-291 for order details. SHOWDOWNDISPLAYS.COM · ASI 87188 · PPAI 254687 · SAGE 67383 · PPPC 20101202

DELUXE / ECONOMY

MENU

production lead time after final proof approval

2-OR-7 DAYS



Aluminum composite

Imprinted chalkboard

## SWING A-FRAME



Attract business with this eye-catching swinging A-frame.

- Modern frame constructed of black steel
- Included clips make it easy to attach the sign to the top of the frame
- Artwork is printed on double-sided chalkboard or aluminum composite; unimprinted chalkboard is also available
- Recommended for indoor or limited outdoor use
- Hex wrench included

### Swing A-Frame

Item #	Description	1	2-5	6-11	12-24
263543	Aluminum Composite Kit	417.50	402.50	387.50	372.50
263540	Imprinted Chalkboard Kit	361.75	348.50	335.25	321.75
263541	Unimprinted Chalkboard* Kit	300.75	288.50	276.50	264.50

Setup fee: \$20(G)

Pricing is subject to change.

Kit Includes: Hardware and Double-Sided Graphic  
\*Unimprinted chalkboard is blank

USD MSRP (C)

Description	Product Size	Finished Graphic Size	Product Wt.	Media
aluminum	22.5"W x 37.625"H x 27.5"D	view online template	14 lbs.	aluminum composite
chalkboard	22.5"W x 37.625"H x 27.5"D	view online template	16.2 lbs.	chalkboard



Chalk or chalk markers work in unimprinted areas only (chalk markers recommended; not included).

## UPTOWN A-FRAME



This A-frame presents your message with a touch of class.

- Recommended for indoor use
- Artwork is printed on durable rigid PVC board
- Frame constructed of high-grade aluminum with a silver matte finish
- Foot pegs prevent the A-frame from scratching floors or slipping

### Uptown A-Frame

Item #	Description	1	2-5	6-11	12-24
263190	40" Kit	377.75	366.00	349.25	337.75
263192	45" Kit	416.00	403.50	385.00	372.50

Setup fee: \$20(G)

Pricing is subject to change.

Kit Includes: Hardware, 2 Single-Sided Graphics and 1 Double-Sided Rider Graphic Panel

USD MSRP (C)

Description	Product Size	Finished Graphic Size	Product Wt.	Media
40"	18.75"W x 40.875"H x 29"D	view online template	15.5 lbs.	rigid PVC board
45"	26.625"W x 45.375"H x 32.625"D	view online template	24.25 lbs.	rigid PVC board



Edges flip open so swapping out signboards is easy.



Rider panel simply slides into a slot in the top of the frame.



SWING UPTOWN production lead time after final proof approval

**3-OR-2 DAYS**

UNIMPRINTED CHALKBOARD ONLY LEAD TIME: SHIPS SAME DAY WHEN ORDERED BEFORE 2 PM CENTRAL

**PRICES ARE SUBJECT TO CHANGE.** No setup fee on orders placed via our website.

Visit [showdowndisplays.com](http://showdowndisplays.com) for current pricing, graphic templates, product videos and assembly instructions. See pages 288-291 for order details.

SHOWDOWNDISPLAYS.COM · ASI 87188 · PPAI 254687 · SAGE 67383 · PPPC 20101202

## UPTOWN ACCENT A-FRAME



With so many ways to display, the Uptown Accent is an impressively versatile A-frame.

- Recommended for indoor use
- Artwork is printed on durable rigid PVC board
- Frame constructed of high-grade aluminum with a silver matte finish
- Foot pegs prevent the A-frame from scratching floors or slipping



Rider panel simply slides into a slot in the top of the frame.

### Uptown Accent A-Frame

Item #	Description	1	2-5	6-11	12-24
263196	Kit	451.50	438.75	418.25	405.50

Setup fee: \$20(G)

Pricing is subject to change.

Kit Includes: Hardware, 2 Single-Sided Graphics, 2 Single-Sided Accent Graphic Panels and 1 Double-Sided Rider Graphic Panel USD MSRP (C)

Product Size	Finished Graphic Size	Product Wt.	Media
25.625"W x 50.875"H x 35.75"D	view online template	30.5 lbs.	rigid PVC board



Edges flip open so swapping out signboards is easy.



Accent panel slides into a slot on the side of the frame.

## GALLERIA A-FRAME



This A-frame impresses passersby with the upscale look of fabric. The lightweight frame makes this easy to move around, and the graphic can be swapped out easily to keep your messaging fresh.

- Graphic panel wraps around the top to create a two-sided display
- Artwork is dye sublimated on recycled polyester knit
- 100% recycled media is made with fibers recycled from plastic bottles
- Push-button connectors for easy assembly
- Indoor use only
- Includes a drawstring pouch for easy transport



Graphic has sewn in loop fasteners.



Lightweight aluminum frame that is similar to our EuroFit line.

### Galleria A-Frame

Item #	Description	1	2-5	6-11	12-24
263570	Kit	353.25	340.00	326.75	313.25

Patent Pending

Setup fee: \$20(G)

Pricing is subject to change.

Kit Includes: Hardware, Graphic Panel and Drawstring Pouch USD MSRP (C)

Product Size	Finished Graphic Size	Product Wt.	Media
27.25"W x 41.5"H x 27.5"D	view online template	6.8 lbs.	recycled polyester knit



Graphic attaches to the frame with hook-and-loop for easy installation.





With a quick press of your thumb, the fabric's gasket edges are pushed into narrow channels built into the frame.



## IMPRESS LITE A-FRAME



This lightweight and compact A-frame is destined to impress.

- A-frame includes two easy-to-install single-sided graphic panels to create a two-sided display
- Artwork is vibrantly dye sublimated on recycled polyester knit
- 100% recycled media is made with fibers recycled from plastic bottles
- SEG provides a modern, frameless look
- Lightweight aluminum frame
- Indoor use only

### Impress Lite A-Frame

Item #	Description	1	2-5	6-11	12-24
264315	Kit	299.75	289.25	278.50	268.00

Setup fee: \$20(G)

Pricing is subject to change.

Kit Includes: Hardware and 2 Graphic Panels

USD MSRP (C)

Product Size	Finished Graphic Size	Product Wt.	Media
23.375"W x 43.75"H x 32"D	view online template	11 lbs.	recycled polyester knit



Side hinges secure the display when in use.



Pull tab lets you quickly remove SEG panel from the frame.

## SUPERSTRONG ANGLE IRON A-FRAME



Constructed of iron, this is the strongest A-frame we offer.

- Durable iron frame with black powder-coated finish
- Artwork is printed single-sided on 4 mm corrugated plastic
- Accepts rigid substrates such as aluminum composite and corrugated plastic up to 0.25" thick
- Great for outdoor use

### Superstrong Angle Iron A-Frame

Item #	Description	1	2-5	6-11	12-24
381014	24" x 18" Kit	131.60	128.00	121.90	118.20
271078	24" x 18" Signboard Only (1)	21.23	20.59	19.96	19.32
381012	24" x 36" Kit	166.60	162.40	154.40	150.20
271079	24" x 36" Signboard Only (1)	31.99	31.03	30.07	29.11

Setup fee: \$20(G)

Pricing is subject to change.

Kit Includes: Hardware and 2 Single-Sided Graphics

USD MSRP (C)

Description	Product Size	Finished Graphic Size	Product Wt.	Media
24" x 18"	24.5"W x 25"H x 24"D	view online template	6.5 lbs.	4 mm corrugated plastic
24" x 36"	24.25"W x 40.5"H x 25"D	view online template	13.5 lbs.	4 mm corrugated plastic



24" x 36"

24" x 18"



24" x 18" hardware has tabs on the sides to hold the signboard in place.



Fasteners are included with 24" x 36" hardware.



Built-in handle for easy transport.

IMPRESS LITE SUPERSTRONG production lead time after final proof approval

4-OR-2 DAYS

PRICES ARE SUBJECT TO CHANGE. No setup fee on orders placed via our website.

Visit [showdowndisplays.com](http://showdowndisplays.com) for current pricing, graphic templates, product videos and assembly instructions. See pages 288-291 for order details.

SHOWDOWNDISPLAYS.COM · ASI 87188 · PPAI 254687 · SAGE 67383 · PPPC 20101202



## HORIZONTAL A-FRAME



This aluminum A-frame is built to handle outdoor conditions.

- Lightweight and portable
- Artwork is printed on Titan™ 13 oz. scrim vinyl
- Banners used outdoors have a 90-day warranty; banners used indoors have a 1-year warranty



### Horizontal A-Frame

Item #	Description	1	2-5	6-11	12-24
210109	4' Kit	404.25	392.00	380.00	367.75
210107	8' Kit	633.50	614.50	595.50	576.50

Setup fee: \$20(G)

Pricing is subject to change.

Kit Includes: Hardware, Stakes, Bungee Cords, 2 Single-Sided Graphics and Soft Carry Case

USD MSRP (C)

Description	Product Size	Finished Graphic Size	Product Wt.	Media
4'	51"W x 38"H x 24.75"D	view online template	11 lbs.	Titan™ 13 oz. scrim vinyl
8'	100.75"W x 38"H x 24.75"D	view online template	18 lbs.	Titan™ 13 oz. scrim vinyl



Bungee cords attach to grommets on the banner, so swapping out banners is easy.



Included stakes help keep the A-frame anchored.

## TWIST-UP OVAL A-FRAME



This display twists in on itself, collapsing into a highly compacted, extremely portable unit.

- Artwork is dye sublimated on recycled polyester knit
- 100% recycled media is made with fibers recycled from plastic bottles
- Four ground stakes included to secure the display
- Graphic covers used outdoors have a 90-day warranty; graphic covers used indoors have a 1-year warranty



### Twist-Up Oval A-Frame

Item #	Description	1	2-5	6-11	12-24
210318	Kit	431.25	418.25	405.25	392.50

Setup fee: \$20(G)

Pricing is subject to change.

Kit Includes: Hardware, 4 Stakes, 2 Single-Sided Installed Graphic Covers and Soft Carry Case

USD MSRP (C)

Product Size	Finished Graphic Size	Product Wt.	Media
80.25"W x 33.5"H x 23"D	view online template	8.25 lbs.	recycled polyester knit



The display features grommets so it can be tethered to the ground using included stakes.



Twists down to a 34" diameter circle that fits neatly into the included carry case.



**PRICES ARE SUBJECT TO CHANGE.** No setup fee on orders placed via our website. Visit [showdowndisplays.com](http://showdowndisplays.com) for current pricing, graphic templates, product videos and assembly instructions. See pages 288-291 for order details. SHOWDOWNDISPLAYS.COM · ASI 87188 · PPAI 254687 · SAGE 67383 · PPPC 20101202

HORIZONTAL TWIST-UP production lead time after final proof approval  
**2-OR-5 DAYS**



Sold in sets of two.



Pair with a tent weight for outdoor use (sold separately; see page 127).

## CORO A-FRAME



Our lightest A-frame gives you a simple, inexpensive way to promote your message.

- Artwork is printed single-sided on 4 mm corrugated plastic
- A-frame is folded into an A shape; different artwork can be used on each side
- Bottom sections overlap for a stable base; folds flat for easy transport and storage
- Tool-free assembly
- Corrugated plastic can be recycled after use

### Coro A-Frame

Item #	Description	1	2-5	6-11	12-24
271125	Kit (Set of 2)	95.35	92.50	89.60	86.75

Setup fee: \$20(G)

Pricing is subject to change.

Kit Includes: 2 A-frame Imprinted Signs

USD MSRP (C)

Product Size	Finished Graphic Size	Product Wt.	Media
22"W x 35.5"H x 12"D	view online template	4 lbs.	4 mm corrugated plastic

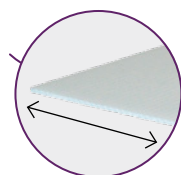

Stakes slide into fluted openings along the width of the signboard.

## CORRUGATED PLASTIC SIGN



Great for use on lawns, this sign gives you an economical and professional way to get your message noticed.

- Constructed of 4 mm corrugated plastic
- Full-color artwork can be printed on one or both sides
- Custom sizes and shapes available (call for quote; restrictions may apply)
- Corrugated plastic can be recycled after use

### Corrugated Plastic Sign

Item #	Description	1	2-5	6-11	12-24
271109	36"W x 24"H Unimprinted	8.38	8.13	7.88	7.63
271110	36"W x 24"H Single-Sided	27.57	26.74	25.92	25.09
271111	36"W x 24"H Double-Sided	36.21	35.12	34.04	32.95
271112	24"W x 18"H Unimprinted	4.95	4.80	4.65	4.50
271113	24"W x 18"H Single-Sided	18.28	17.73	17.18	16.63
271114	24"W x 18"H Double-Sided	23.89	23.17	22.46	21.74

Imprinted sign setup fee: \$20(G)

Pricing is subject to change.

USD MSRP (C)

### Corrugated Plastic Sign Kit

Item #	Description	1	2-5	6-11	12-24
271133	36"W x 24"H Unimprinted Kit	11.21	10.96	10.71	10.40
271134	36"W x 24"H Single-Sided Kit	30.40	29.57	28.75	27.86
271135	36"W x 24"H Double-Sided Kit	39.04	37.95	36.87	35.72
271136	24"W x 18"H Unimprinted Kit	7.78	7.63	7.48	7.28
271137	24"W x 18"H Single-Sided Kit	21.11	20.56	20.01	19.41
271138	24"W x 18"H Double-Sided Kit	26.72	26.00	25.29	24.51

Imprinted sign setup fee: \$20(G)

Pricing is subject to change.

Kit Includes: Standard Step Stake and Unimprinted, Single- or Double-Sided Graphic

USD MSRP (C)



Custom shapes available online. Approved custom sizes and shapes are produced with a 1/2" white border. Step stake sold separately.

## STANDARD STEP STAKE

- Installation is quick and easy

### Standard Step Stake

Item #	Description	1-10	11-20	21-30	31+
381501	Standard Step Stake	2.83	2.77	2.69	2.63

Pricing is subject to change.

USD MSRP (C)

production lead time  
after final proof approval

# 2 DAYS

HARDWARE-ONLY LEAD TIME: SHIPS SAME DAY WHEN ORDERED BEFORE 2 PM CENTRAL

PRICES ARE SUBJECT TO CHANGE. No setup fee on orders placed via our website.

Visit [showdowndisplays.com](http://showdowndisplays.com) for current pricing, graphic templates, product videos and assembly instructions. See pages 288-291 for order details.

SHOWDOWNDISPLAYS.COM · ASI 87188 · PPAI 254687 · SAGE 67383 · PPPC 20101202

## WAYFINDING SIGN



Don't let your guests get lost! Provide direction with this rigid sign that can be attached to most signposts.

- Artwork is UV-printed on aluminum composite
- Available in a rectangular shape, or tipped with a pointed arrow
- Artwork is printed on both sides of the sign; different artwork can be used on each side



### Wayfinding Sign

Item #	Description	1	2-5	6-11	12-24
263580	Arrow Kit	116.70	112.60	108.50	104.40
263581	Rectangle Kit	93.20	89.85	86.45	83.05

Setup fee: \$20(G)

Pricing is subject to change.

Kit Includes: Mounting Hardware and Double-Sided Graphic

USD MSRP (C)

Description	Product Size	Finished Graphic Size	Product Wt.	Media
arrow	25.25"W x 6"H x 2.25"D	view online template	1.2 lbs.	aluminum composite
rectangle	25.25"W x 6"H x 2.25"D	view online template	1.2 lbs.	aluminum composite



Display as either a rectangle or an arrow to point the way.



Easy installation with the included mounting bracket. Fits poles with a 3.5"-8.5" diameter.

## PARKING PAL



This reflective sign has a narrow footprint and can be stacked for storage, making it perfect for event parking, rideshare locations or public garages.

- Artwork is printed on reflective media
- Two single-sided decals make a double-sided display
- Durable plastic construction prevents rust and splinters
- Maintenance-free and weather-resistant
- NCHRP compliant; Federal Highway Administration approved
- Decals used outdoors have a 90-day warranty; decals used indoors have a 1-year warranty



### Parking Pal

Item #	Description	1	2-5	6-11	12-24
264260	Kit	175.10	168.90	162.70	156.50

Setup fee: \$20(G)

Pricing is subject to change.

Kit Includes: Hardware and 2 Installed Single-Sided Graphic Decals

USD MSRP (C)

Product Size	Finished Graphic Size	Product Wt.	Media
17.625"W x 44.75"H x 14.5"D	view online template	13 lbs.	reflective media



Removable rubber base for added stability.

**PRICES ARE SUBJECT TO CHANGE.** No setup fee on orders placed via our website. Visit [showdowndisplays.com](http://showdowndisplays.com) for current pricing, graphic templates, product videos and assembly instructions. See pages 288-291 for order details. SHOWDOWNDISPLAYS.COM · ASI 87188 · PPAI 254687 · SAGE 67383 · PPPC 20101202

production lead time after final proof approval  
**3 DAYS**

## ROVER PORTABLE SIGN POST



The best addition to your curbside or parking lot directs your customers where they need to be.

- Artwork is UV-printed on aluminum composite
- Square post attaches flush to sign
- Sign is printed single-sided; double-sided kits include two signs
- 60" base can be filled with 60-80 lbs. of silica sand for additional stability;
- 72" base can be filled with 150-180 lbs.
- Wrench needed for assembly (not included)



Transport sign easily with durable wheeled plastic base.



72" double-sided kit

60" single-sided kit



Secure base and sign(s) with included hardware.



Strong plastic post is reinforced with center cross bars.

## Rover Portable Sign Post

Item #	Description	1	2-5	6-11	12-24
264500	60" Single-Sided Kit	248.20	238.70	229.10	219.60
264501	60" Double-Sided Kit	283.25	275.00	266.50	258.25
264505	72" Single-Sided Kit	320.75	308.25	296.00	283.50
264506	72" Double-Sided Kit	361.75	350.50	339.50	328.50

## Setup fee: \$20(G)

Single-Sided Kit Includes: Hardware and Single-Sided Graphic  
Double-Sided Kit Includes: Hardware and 2 Single-Sided Graphics

## Pricing is subject to change.

USD MSRP (C)

Description	Product Size	Finished Graphic Size	Product Wt. (Single / Double)	Media
60"	18.2"W x 63.7"H x 19.5"D	view online template	11.4 lbs. / 12.4 lbs.	aluminum composite
72"	23.35"W x 77"H x 25.5"D	view online template	16 lbs. / 18 lbs.	aluminum composite

## OUTDOOR FLEX SIGN



This spring-mounted sign is built to withstand the elements.

- Each poster is protected behind a sheet of clear, non-glare acrylic
- Graphics are printed single-sided; two graphics included in kit
- Ballast base holds 4.5 gallons of water; weighs 63 lbs. when filled
- Tool-free assembly

## Outdoor Flex Sign

Item #	Description	1	2-5	6-11	12-24
210127	Flex Sign Kit	485.25	470.75	456.25	441.50
263006	Flex Sign with Ballast Base Kit	532.50	516.50	500.50	484.50

## Setup fee: \$20(G)

Kit Includes: Hardware, 2 Protective Acrylic Sheets and 2 Single-Sided Graphics

## Pricing is subject to change.

USD MSRP (C)

Description	Product Size	Finished Graphic Size	Product Wt.	Media
sign	25.5"W x 44"H x 29"D	view online template	27 lbs.	Titan™ 10 oz. scrim vinyl
sign w/ ballast base	31"W x 46"H x 20"D	view online template	26 lbs.	Titan™ 10 oz. scrim vinyl



Flex Sign

Flex Sign with Ballast Base



Edges flip open for easy poster changes.



Spring-mounted base allows sign to gently flex in the wind.



Wheels on the ballast base make it easy to move.



Ballast base can be filled with water or sand for stability.

ROVER OUTDOOR production lead time after final proof approval  
**3-OR-2 DAYS**

102

**PRICES ARE SUBJECT TO CHANGE.** No setup fee on orders placed via our website. Visit [showdowndisplays.com](http://showdowndisplays.com) for current pricing, graphic templates, product videos and assembly instructions. See pages 288-291 for order details.

SHOWDOWNDISPLAYS.COM · ASI 87188 · PPAI 254687 · SAGE 67383 · PPPC 20101202

## FRAMEWORX FLEX



Our popular FrameWorx display is fitted with a mesh fabric banner and ballast to be used outdoors.

- Designed for short-term outdoor use
- Banner features clear plastic grommets
- Artwork is dye sublimated on mesh fabric
- Wheels on the base make it easy to move
- Base holds 8 gallons of water; weighs 76.6 lbs. when filled
- Tool-free assembly
- Banners used outdoors have a 90-day warranty; banners used indoors have a 1-year warranty

### FrameWorx Flex

Item #	Description	1	2-5	6-11	12-24
210342	Single-Banner Kit	700.50	672.50	644.50	616.50
210343	Double-Banner Kit	876.50	856.00	805.00	785.00

Setup fee: \$20(G)

Pricing is subject to change.

Kit Includes: Hardware, Single-Sided Graphic(s) and Soft Carry Case USD MSRP (C)

Product Size	Finished Graphic Size	Product Wt. (Single / Double)	Media
41.25"W x 98.875"H x 21.5"D	view online template	27 lbs. / 27.5 lbs.	mesh fabric

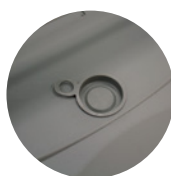

Ballast base can be filled with water or sand for stability.

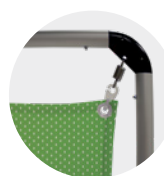

Tension corner springs keep the banner centered and taut.

## EUROFIT FLEX SIGN



Our wildly popular EuroFit display combined with a flexible ballast base adds motion to your message.

- Available in two sizes
- Artwork is printed on recycled polyester knit
- 100% recycled media is made with fibers recycled from plastic bottles
- Easy assembly with lightweight aluminum push-button poles
- Ballast base holds 6.6 gallons of water; weighs 55 lbs. when filled
- Graphics used outdoors have a 90-day warranty; graphics used indoors have a 1-year warranty

### EuroFit Flex Sign

Item #	Description	1	2-5	6-11	12-24
263560	50" H Kit	474.75	457.00	439.25	421.25
263561	90" H Kit	586.00	564.00	542.50	521.00

Setup fee: \$20(G)

Pricing is subject to change.

Kit Includes: Hardware and Graphic Cover USD MSRP (C)

Description	Product Size	Finished Graphic Size	Product Wt.	Media
50"H	31"W x 49.5"H x 19.5"D	view online template	16.2 lbs.	recycled polyester knit
90"H	31"W x 87.25"H x 19.5"D	view online template	16.8 lbs.	recycled polyester knit



Spring-mounted base allows sign to gently flex in the wind.



Ballast base can be filled with water or sand for stability; wheels make it easy to move.



**PRICES ARE SUBJECT TO CHANGE.** No setup fee on orders placed via our website. Visit [showdowndisplays.com](http://showdowndisplays.com) for current pricing, graphic templates, product videos and assembly instructions. See pages 288-291 for order details. SHOWDOWNDISPLAYS.COM · ASI 87188 · PPAI 254687 · SAGE 67383 · PPPC 20101202

production lead time after final proof approval  
**4 DAYS**



## SUNRISE LAWN SIGN



Silhouetted like the rising sun, this lightweight variation on our popular sail signs is perfect for frequent outdoor use.

- Artwork is dye sublimated on super poly knit fabric for single-sided banners and on block-out polyester for double-sided banners
- Flexible fiberglass poles can be used with both banner size options
- Included ground stakes keep the display stationary in the breeze
- Lightweight and portable
- Banners have a 90-day warranty

### Sunrise Lawn Sign

Item #	Description	1	2-5	6-11	12-24
263340	5'W x 4'H Single-Sided Kit	141.50	136.80	132.00	127.30
263341	5'W x 4'H Double-Sided Kit	222.30	215.20	208.00	200.90
263345	3'W x 5'H Single-Sided Kit	128.00	123.70	119.40	115.10
263346	3'W x 5'H Double-Sided Kit	195.30	189.00	182.70	176.30

Setup fee: \$20(G)

Pricing is subject to change.

Kit Includes: Hardware, Single- or Double-Sided Graphic and 2 Stakes

USD MSRP (C)

Description	Product Size	Finished Graphic Size	Product Wt.	Media (Single / Double)
5'W x 4'H	59.5"W x 48"H x 1.625"D	view online template	2.3 lbs.	super poly knit fabric / block-out polyester
3'W x 5'H	31.25"W x 56.625"H x 1.625"D	view online template	2.1 lbs.	super poly knit fabric / block-out polyester



5'W x 4'H Sunrise Multisurface Sign

3'W x 5'H Sunrise Lawn Sign

Black tabs on bottom of banner attach to metal pin on ground stakes.

Double-sided banners feature a lightweight block-out polyester.



## SUNRISE BOARDWALK STAND

- Converts Sunrise Lawn Sign into the Sunrise Multisurface Sign
- Stand can be adjusted to fit both sizes of the Sunrise Lawn Sign
- Includes two square water ballasts

### Sunrise Boardwalk Stand

Item #	Description	Product Wt.	1	2-5	6-11	12-24
263351	Stand	11.7 lbs.	195.40	187.60	179.80	171.90

Pricing is subject to change.

USD MSRP (C)

## SUNRISE MULTISURFACE SIGN



The popular Sunrise Lawn Sign has been transformed to bring its unique shape to any event.

- Display on virtually any surface; kit includes stakes for soft surfaces and boardwalk stand with water ballasts for hard surfaces
- Artwork is dye sublimated on super poly knit fabric for single-sided banners and on block-out polyester for double-sided banners
- Boardwalk stand has an easy push-button assembly
- Banners have a 90-day warranty

### Sunrise Multisurface Sign

Item #	Description	1	2-5	6-11	12-24
907070	5'W x 4'H Single-Sided Kit	336.75	324.25	311.75	299.25
907071	5'W x 4'H Double-Sided Kit	417.75	402.75	387.75	372.75
907072	3'W x 5'H Single-Sided Kit	323.50	311.25	299.25	287.00
907073	3'W x 5'H Double-Sided Kit	390.75	376.50	362.50	348.25

Setup fee: \$20(G)

Pricing is subject to change.

Kit Includes: Pole Hardware, Single- or Double-Sided Graphic, Boardwalk Base, 2 Stakes and 2 Square Water Ballasts

USD MSRP (C)

Description	Product Size	Finished Graphic Size	Product Wt. (Single / Double)	Media (Single / Double)
5'W x 4'H	62.25"W x 48"H x 28.5"D	view online template	13.7 lbs. / 14 lbs.	super poly knit fabric / block-out polyester
3'W x 5'H	40.125"W x 56.625"H x 28.5"D	view online template	13.5 lbs. / 13.8 lbs.	super poly knit fabric / block-out polyester

production lead time after final proof approval

# 4 DAYS

**HARDWARE-ONLY LEAD TIME: SHIPS SAME DAY WHEN ORDERED BEFORE 2 PM CENTRAL**

**PRICES ARE SUBJECT TO CHANGE.** No setup fee on orders placed via our website.

Visit [showdowndisplays.com](http://showdowndisplays.com) for current pricing, graphic templates, product videos and assembly instructions. See pages 288-291 for order details.

SHOWDOWNDISPLAYS.COM · ASI 87188 · PPAI 254687 · SAGE 67383 · PPPC 20101202

## TOWER TILES



Create dynamic, eye-catching displays with these double-sided stackable tiles.

- Stackable design allows for customizable configurations
- Double-sided printing ensures your message is visible from every angle
- Artwork is vibrantly printed on 3 mm paperboard that is recyclable and is certified FSC
- Durable tiles are built to last through repeated use without compromising stability
- Quick and easy assembly



6 cube

2 and 3 cube on an 8' Standard throw shown in white (sold separately; see page 12)

### Tower Tiles

Item #	Description	1	2-5	6-11	12-24
271190	2 Cube Tabletop Kit	85.00	81.60	78.20	74.80
271191	3 Cube Tabletop Kit	125.00	120.00	115.00	110.00
271192	6 Cube Floor Kit	185.00	177.60	170.20	162.80

Setup fee: \$20(G)

Pricing is subject to change.

Kit Includes: Middle Panels, 2 Top Panels and 2 Bottom Panels

USD MSRP (C)

Description	Product Size	Finished Graphic Size	Product Wt.	Media
2 cube	15.5"W x 30.125"H x 15.5"D	view online template	3.2 lbs.	3 mm paperboard
3 cube	15.5"W x 40.75"H x 15.5"D	view online template	4.2 lbs.	3 mm paperboard
6 cube	15.5"W x 75.625"H x 15.5"D	view online template	7.8 lbs.	3 mm paperboard



Each tile is slotted for easy assembly of your cubes.

## TOWER TRIO



This display features three stackable pieces that are easy to put together and look great in any space.

- Constructed of 4 mm corrugated plastic
- Stands more than 5' tall when assembled
- Triangle comes in nine individual pieces; includes 18 clear tabs for easy assembly
- Cube comes in 12 individual pieces; includes 24 clear tabs for easy assembly
- Corrugated plastic can be recycled after use

### Tower Trio

Item #	Description	1	2-5	6-11	12-24
271180	Triangle Kit	203.70	197.20	190.80	185.80
271181	Cube Kit	271.50	263.00	254.50	247.70

Setup fee: \$20(G)

Pricing is subject to change.

Triangle Kit Includes: 9 Graphic Panels and 18 Clear Tabs

USD MSRP (C)

Cube Kit Includes: 12 Graphic Panels and 24 Clear Tabs

Description	Product Size	Finished Graphic Size	Product Wt.	Media
triangle	24"W x 64.25"H x 24"D	view online template	6 lbs.	4 mm corrugated plastic
cube	32.75"W x 63.5"H x 32.75"D	view online template	8 lbs.	4 mm corrugated plastic



Cube

Triangle



Clear tabs attach to the corners of the display to hold the pieces together.

Graphic panels are printed single-sided.

PRICES ARE SUBJECT TO CHANGE. No setup fee on orders placed via our website. Visit [showdowndisplays.com](http://showdowndisplays.com) for current pricing, graphic templates, product videos and assembly instructions. See pages 288-291 for order details.

SHOWDOWNDISPLAYS.COM · ASI 87188 · PPAI 254687 · SAGE 67383 · PPPC 20101202

production lead time after final proof approval  
**2DAYS**

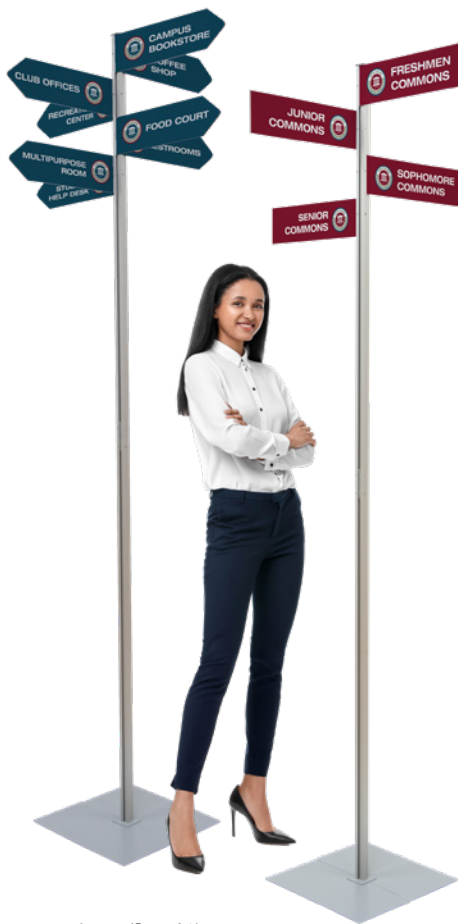

Arrow (Set of 8)

Rectangle (Set of 4)

## WAYFINDING SIGN POST



This signpost is a true classic. Offer guidance with directional signage that can be attached to all four sides.

- Post is constructed of aluminum, with a steel base for stability
- Signage easily slides into slots in the post
- Artwork is UV-printed on aluminum composite
- Artwork is printed on both sides of the sign; different artwork can be used on each side
- Maximum of 16 signs can be attached to the post

### Wayfinding Sign Post

Item #	Description	1	2-5	6-11	12-24
263650	Rectangle Kit (Set of 4)	353.50	340.00	326.75	313.25
263651	Rectangle Kit (Set of 8)	424.25	408.75	393.00	377.50
263652	Arrow Kit (Set of 4)	383.75	369.50	355.00	340.75
263653	Arrow Kit (Set of 8)	484.75	467.50	450.00	432.75

**Setup fee: \$20(G)**

**Pricing is subject to change.**

Kit Includes: Hardware, 4 or 8 Double-Sided Graphics and Drawstring Pouch

USD MSRP (C)

Description	Product Size	Finished Graphic Size	Product Wt. (Four / Eight)	Media
rectangle	29.375"W x 87.375"H x 29.375"D	view online template	13.6 lbs. / 15.2 lbs.	aluminum composite
arrow	29.375"W x 87.375"H x 29.375"D	view online template	13.6 lbs. / 15.2 lbs.	aluminum composite



Included hex wrenches are used to tighten pole, base and graphics.

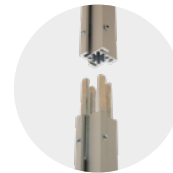

Slide poles together for assembly.



## ADJUSTABLE SIGN DISPLAY



Boost your visibility with this Adjustable Sign Display.

- Artwork is vibrantly printed on 3 mm paperboard that is recyclable and is certified FSC
- Durable black steel frame
- Weighted base for enhanced stability
- Hardware can be adjusted to display a 22.25"-40"H signboard and can hold various media up to 0.375" thick; custom sizes available (call for quote; restrictions may apply)

### Adjustable Sign Display

Item #	Description	1	2-5	6-11	12-24
263590	Kit	153.70	147.60	141.40	135.30

**Setup fee: \$20(G)**

**Pricing is subject to change.**

Kit Includes: Hardware, Graphic and Zippered Carry Pouch

USD MSRP (C)

Product Size	Finished Graphic Size	Product Wt.	Media
24"W x 49.5"-58.5"H x 10.375"D	view online template	7.4 lbs.	3 mm paperboard



Angle your display to create the visibility you need.

production lead time  
after final proof approval

# 2DAYS

## FLAT BASE SIGN DISPLAY



This sign display shows off your message with style.

- Contemporary look with rectangular tube frame and a sturdy base
- Frame constructed of steel
- Hardware is available in black or chrome
- Artwork is printed on 4 mm corrugated plastic
- Double-sided display



Easily showcase specials or other promotions.



Chrome

Black

### Flat Base Sign Display

Item #	Description	1	2-5	6-11	12-24
400055	Kit	211.60	205.20	198.90	192.50

**Setup fee: \$20(G)**      **Pricing is subject to change.**

Kit Includes: Black or Chrome Hardware and Double-Sided Graphic      USD MSRP (C)

Product Size	Finished Graphic Size	Product Wt.	Media
22.25"W x 59.75"H x 10"D	view online template	13.5 lbs.	4 mm corrugated plastic

## LUXE GLO SIGN DISPLAYS



Light up your brand with these LED displays that will last for years.

- Artwork is vibrantly printed on white polycarbonate
- Luxe Glo Message Board artwork spans the entire sign; red fluorescent marker included
- UL listed
- Not eligible for Rush Service



Use included red fluorescent marker for messages.



15"W x 18"H  
Luxe Glo Message Board

15" Round  
Luxe Glo Sign

18"W x 15"H  
Luxe Glo Edge

### Luxe Glo Sign

Item #	Description	Product Wt.	1	2-5	6-11	12-24
271150	15" Round	3 lbs.	349.50	335.50	321.50	307.50
271151	23" Round	6.6 lbs.	476.75	457.75	438.50	419.50
271152	18"W x 15"H Rectangle	3 lbs.	381.25	366.00	350.75	335.50
271153	23"W x 18"H Rectangle	6.4 lbs.	476.75	457.75	438.50	419.50

**Setup fee: \$20(G)**      **Pricing is subject to change.**  
USD MSRP (C)

### Luxe Glo Edge

Item #	Description	Product Wt.	1	2-5	6-11	12-24
271160	18"W x 15"H	4.6 lbs.	381.25	366.00	350.75	335.50
271161	23"W x 18"H	6.6 lbs.	476.75	457.75	438.50	419.50

**Setup fee: \$20(G)**      **Pricing is subject to change.**  
USD MSRP (C)

### Luxe Glo Message Board

Item #	Description	Product Wt.	1	2-5	6-11	12-24
271170	15"W x 18"H Kit	3.2 lbs.	381.25	366.00	350.75	335.50
271171	18"W x 23"H Kit	6.4 lbs.	476.75	457.75	438.50	419.50

**Setup fee: \$20(G)**      **Pricing is subject to change.**  
Kit Includes: Imprinted Sign and Red Fluorescent Marker      USD MSRP (C)



Hanging and wall-mounting hardware included.



CALL YOUR REP FOR LEAD TIMES ON LUXE GLO SIGN QUANTITIES OVER 12  
**PRICES ARE SUBJECT TO CHANGE.** No setup fee on orders placed via our website.  
 Visit [showdowndisplays.com](http://showdowndisplays.com) for current pricing, graphic templates, product videos and assembly instructions. See pages 288-291 for order details.  
 SHOWDOWNDISPLAYS.COM · ASI 87188 · PPAI 254687 · SAGE 67383 · PPPC 20101202

FLAT BASE LUXE GLO production lead time after final proof approval  
**2-OR-7 DAYS**

## COMING SOON



30" x 60"

30" x 40"

16" x 20"

## VALUE WALL-MOUNT SEG



This SEG display is ideal for long-term use in office or retail settings.

- Easily change out graphic to update messaging
- SEG provides a clean, frameless look
- Artwork is dye sublimated on recycled polyester knit
- 100% recycled media is made with fibers recycled from plastic bottles
- 1.25" frame depth
- Display can be hung vertically or horizontally
- Mounting hardware and assembly tools included

## Value Wall-Mount SEG

Item #	Description	1	2-5	6-11	12-24
254920	11" x 17" Kit	87.75	84.25	80.75	77.25
254750	16" x 20" Kit	103.30	99.20	95.05	90.95
254923	22" x 28" Kit	122.20	117.30	112.40	107.50
254753	24" x 36" Kit	146.70	140.80	134.90	129.10
254756	30" x 40" Kit	182.20	174.90	167.60	160.30
254926	36" x 48" Kit	208.90	200.50	192.20	183.80
254759	30" x 60" Kit	237.80	228.20	218.70	209.20
254929	48" x 60" Kit	316.75	304.00	291.25	278.75

Setup fee: \$20(G)

Pricing is subject to change.

Kit Includes: Hardware and Graphic Panel

USD MSRP (C)

Description	Product Size	Finished Graphic Size	Product Wt.	Media
11" x 17"	11"W x 17"H x 1.25"D	view online template	2.2 lbs.	recycled polyester knit
16" x 20"	16"W x 20"H x 1.25"D	view online template	2.5 lbs.	recycled polyester knit
22" x 28"	22"W x 28"H x 1.25"D	view online template	3.2 lbs.	recycled polyester knit
24" x 36"	24"W x 36"H x 1.25"D	view online template	3.5 lbs.	recycled polyester knit
30" x 40"	29.875"W x 39.875"H x 1.25"D	view online template	4 lbs.	recycled polyester knit
36" x 48"	36"W x 48"H x 1.25"D	view online template	4.8 lbs.	recycled polyester knit
30" x 60"	30"W x 59.875"H x 1.25"D	view online template	5.25 lbs.	recycled polyester knit
48" x 60"	48"W x 60"H x 1.25"D	view online template	6 lbs.	recycled polyester knit



Pull tab lets you quickly remove SEG panel from the frame.



Included assembly tool lets you easily install corner brackets.

production lead time  
after final proof approval

# 4 DAYS



## STANDARD WALL-MOUNT SEG GLO



Add a lasting glow to your space with this lit SEG display.

- Backlit SEG provides a glow effect
- Artwork is dye sublimated on backlit woven polyester
- 2.5" frame depth
- Frame has a hole on the edge of the frame for the cord.
- Tool-free assembly; mounting hardware included
- Display can be hung vertically or horizontally
- Floor display option also available (see page 237)



Ladder lights mounted on a block-out panel create a glow effect.



36" x 48"

### Standard Wall-Mount SEG Glo

Item #	Description	1	2-5	6-11	12-24
254932	11" x 17" Kit	165.70	159.00	152.40	145.80
254770	16" x 20" Kit	187.30	179.80	172.30	164.80
254935	22" x 28" Kit	233.30	224.00	214.70	205.30
254773	24" x 36" Kit	258.50	248.20	237.90	227.50
254776	30" x 40" Kit	321.75	308.75	296.00	283.25
254938	36" x 48" Kit	434.00	416.75	399.25	382.00
254779	30" x 60" Kit	502.50	482.50	462.50	442.25
254941	48" x 60" Kit	739.00	709.50	680.00	650.50

Setup fee: \$20(G)

Pricing is subject to change.

Kit Includes: Hardware, Back Panel with Ladder Lights and Graphic Panel USD MSRP (C)

Description	Product Size	Finished Graphic Size	Product Wt.	Media
11" x 17"	11"W x 17"H x 2.5"D	view online template	2.8 lbs.	backlit woven polyester
16" x 20"	16"W x 20"H x 2.5"D	view online template	3.7 lbs.	backlit woven polyester
22" x 28"	22"W x 28"H x 2.5"D	view online template	5.3 lbs.	backlit woven polyester
24" x 36"	24"W x 36"H x 2.5"D	view online template	5.8 lbs.	backlit woven polyester
30" x 40"	30"W x 40"H x 2.5"D	view online template	7 lbs.	backlit woven polyester
36" x 48"	36"W x 48"H x 2.5"D	view online template	8 lbs.	backlit woven polyester
30" x 60"	30"W x 60"H x 2.5"D	view online template	9.3 lbs.	backlit woven polyester
48" x 60"	48"W x 60"H x 2.5"D	view online template	12.4 lbs.	backlit woven polyester



Pull tab lets you quickly remove SEG panel from the frame.



Block-out panel prevents the wall from lighting up with the display.



36" x 36"

24" x 24"

36" x 18"

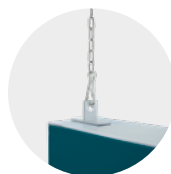

Easily clip on chains to install the SEG display.



Pull tab lets you quickly remove SEG panel from the frame.

## AERIAL SEG



Put your brand where it can't be missed: overhead! This ceiling-mounted kit features beautifully vibrant graphics that hang from two chains to capture every eye in the room.

- Hangs from the ceiling with the included mounting kit, which features two 102" chains, two mounting brackets and a set of ceiling anchors
- SEG for easy graphic panel installation
- 2.375" frame depth
- Artwork is dye sublimated on recycled polyester knit
- 100% recycled media is made with fibers recycled from plastic bottles
- Includes two graphic panels for a double-sided display

### Aerial SEG

Item #	Description	1	2-5	6-11	12-24
263620	24"W x 24"H Kit	388.75	373.25	357.75	342.25
263629	36"W x 18"H Kit	416.75	400.00	383.25	366.75
263623	36"W x 36"H Kit	544.50	522.50	501.00	479.00
263626	48"W x 48"H Kit	694.50	666.50	639.00	611.00

#### Setup fee: \$20(G)

Pricing is subject to change.

Kit Includes: Hardware, 2 Graphic Panels, Hanging Hardware and Soft Carry Case USD MSRP (C)

Description	Product Size	Finished Graphic Size	Product Wt.	Media
24"W x 24"H	24"W x 24.75"H x 2.375"D	view online template	4.4 lbs.	recycled polyester knit
36"W x 18"H	36"W x 18.75"H x 2.375"D	view online template	5 lbs.	recycled polyester knit
36"W x 36"H	36"W x 36.75"H x 2.375"D	view online template	5.8 lbs.	recycled polyester knit
48"W x 48"H	48"W x 48.75"H x 2.375"D	view online template	7.6 lbs.	recycled polyester knit



## AERIAL SEG GLO



This light-up display is a marketing powerhouse that hangs from the ceiling. Elevate your message overhead and emphasize it with a pleasant glow.

- Hangs from the ceiling with the included mounting kit, which features two 102" chains, two mounting brackets and a set of ceiling anchors
- SEG for easy graphic panel installation
- 2.375" frame depth
- Artwork is dye sublimated on backlit woven polyester
- Includes two graphic panels for a double-sided display
- A power button on the frame allows the sign to be turned on and off with a touch of your finger
- Power cord comes out of the top of the display to prevent tangles

### Aerial SEG Glo

Item #	Description	1	2-5	6-11	12-24
263600	24"W x 24"H Kit	694.50	666.50	639.00	611.00
263609	36"W x 18"H Kit	772.00	741.50	710.50	679.50
263603	36"W x 36"H Kit	861.00	826.50	792.00	757.50
263606	48"W x 48"H Kit	1044.00	1003.00	961.00	919.00

#### Setup fee: \$20(G)

Pricing is subject to change.

Kit Includes: Hardware, 2 Graphic Panels, Hanging Hardware and Soft Carry Case USD MSRP (C)

Description	Product Size	Finished Graphic Size	Product Wt.	Media
24"W x 24"H	24"W x 24.75"H x 2.375"D	view online template	5 lbs.	backlit woven polyester
36"W x 18"H	36"W x 18.75"H x 2.375"D	view online template	6 lbs.	backlit woven polyester
36"W x 36"H	36"W x 36.75"H x 2.375"D	view online template	7.6 lbs.	backlit woven polyester
48"W x 48"H	48"W x 48.75"H x 2.375"D	view online template	10.2 lbs.	backlit woven polyester



Button on the side of the frame lets you turn on and off the LED lights.



Built-in LED lights create a glow effect.

production lead time  
after final proof approval

# 4 DAYS

**PRICES ARE SUBJECT TO CHANGE.** No setup fee on orders placed via our website.

Visit [showdowndisplays.com](http://showdowndisplays.com) for current pricing, graphic templates, product videos and assembly instructions. See pages 288-291 for order details.

SHOWDOWNDISPLAYS.COM · ASI 87188 · PPAI 254687 · SAGE 67383 · PPPC 20101202

## OPAQUE WINDOW CLING



Dress up your window with these convenient, reusable, opaque clings.

- Durable and long-lasting
- Clings to window without adhesive; leaves no residue
- Artwork is printed on the non-cling side of the material
- Single-sided; backside will show white
- Removable and reusable
- Indoor or outdoor use
- Clean with standard window cleaner
- Water resistant; fade resistant up to 6-months

### Opaque Window Cling

Item #	Description	Product Wt.	1	2-5	6-11	12-24
325240	8" x 8"	0.02 lb.	17.78	17.25	16.71	16.18
325241	12" x 12"	0.04 lb.	20.35	19.74	19.13	18.52
325242	12" x 18"	0.06 lb.	25.40	24.64	23.88	23.11
325243	18" x 24"	0.11 lb.	33.03	32.04	31.05	30.06
325244	20" x 30"	0.16 lb.	35.60	34.53	33.46	32.40
325245	24" x 24"	0.15 lb.	40.65	39.43	38.21	36.99
325246	24" x 36"	0.23 lb.	45.75	44.38	43.01	41.63
325247	36" x 48"	0.45 lb.	61.05	59.20	57.40	55.55

Setup fee: \$20(G)

Pricing is subject to change.

USD MSRP (C)



Artwork is printed on the non-cling side of the material; cling is adhered to outside of window.



Vibrant colors pop on white opaque window film.

## MAGNET PROMO SIGN



Magnetize your business on the go or in the office with these flexible, magnetic signs.

- Adhere to indoor and outdoor magnetic surfaces
- Flexible single-sided magnet lays flat for a clean look
- Smooth white basecoat makes colors pop
- Recommended to remove magnets daily to clean roadway debris; dirt trapped between the magnet and the vehicle may cause damage
- Custom sizes available (call for quote; restrictions may apply)

### Magnet Promo Sign

Item #	Description	Product Wt.	1	2-5	6-11	12-24
264340	12" x 12"	0.4 lb.	19.07	18.50	17.93	17.35
264341	12" x 18"	0.6 lb.	22.90	22.21	21.53	20.84
264342	12" x 24"	0.8 lb.	25.42	24.66	23.89	23.13
264343	18" x 18"	1 lb.	29.25	28.37	27.50	26.62
264344	18" x 24"	1.2 lbs.	31.77	30.82	29.86	28.91
264345	24" x 24"	1.6 lbs.	35.61	34.54	33.47	32.41

Setup fee: \$20(G)

Pricing is subject to change.

USD MSRP (C)



Black magnet with smooth white basecoat on print side.

**PRICES ARE SUBJECT TO CHANGE.** No setup fee on orders placed via our website. Visit [showdowndisplays.com](http://showdowndisplays.com) for current pricing, graphic templates, product videos and assembly instructions. See pages 288-291 for order details. SHOWDOWNDISPLAYS.COM · ASI 87188 · PPAI 254687 · SAGE 67383 · PPPC 20101202

CLING MAGNET production lead time after final proof approval  
**2-3 DAYS**

## INDOOR SURFACE GRIP



This temporary floor or wall decal works on a variety of surface types, even carpet.

- Textured matte vinyl with fabric backing and solvent acrylic adhesive
- Rounded corners for a finished look
- Easy to apply and remove
- Different artwork can be applied to each footprint/circle
- One-year warranty when used on walls; 30-day warranty when used on floors
- Certified slip resistant (UL410)
- Custom sizes and shapes available (call for quote; restrictions may apply)

### Indoor Surface Grip

Item #	Description	Product Wt.	1	2-5	6-11	12-24
259060	2' x 4'	0.6 lb.	82.75	80.30	77.80	75.30
259065	3' x 5'	1.2 lbs.	163.90	159.00	154.10	149.20
259066	3' x 8'	2 lbs.	245.30	238.00	230.60	223.30
259061	4' x 4'	1.2 lbs.	166.50	161.50	156.50	151.50
259067	4' x 6'	1.4 lbs.	223.70	217.00	210.30	203.60
259062	4' x 8'	2.4 lbs.	324.25	314.50	304.75	295.00
259069	12" Circle (Set of 3)	0.05 lb.	50.85	49.32	47.80	46.27
259089	12" Circle (Set of 6)	0.1 lb.	98.65	95.65	92.70	89.75
259068	18" Circle (Set of 6)	0.2 lb.	125.90	122.10	118.30	114.50
259063	42" Circle	0.6 lb.	166.50	161.50	156.50	151.50
259064	72" x 42" Arrow	0.8 lb.	394.25	382.25	370.50	358.75
259088	Footprints (Set of 10)	0.2 lb.	44.24	42.91	41.59	40.26

Setup fee: \$20(G)

Pricing is subject to change.

USD MSRP (C)



42" Circle



Footprints (Set of 10)



12" Circle (Set of 6)



Finished with rounded corners.

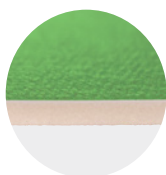

2.4 mm PVC-coated fabric is backed with PVC foam.

## FLOOR DECOR



High-quality, foam-backed flooring is extremely durable, and it's perfect for grabbing attention in lobbies or at events.

- Artwork is printed on one side of the Floor Decor
- Lays flat for a clean, smooth look
- Wipes clean with a damp cloth
- Custom sizes and shapes available (call for quote; restrictions may apply)
- Best for indoor use
- 10' x 10' and 9' round Floor Decor must ship by truck

### Floor Decor

Item #	Description	Product Wt.	1	2-5	6-11	12-24
259058	3' x 3'	1.6 lbs.	275.75	267.50	259.25	251.00
259059	3' Round	1.2 lbs.	275.75	267.50	259.25	251.00
259050	8' x 8'	14 lbs.	1106.00	1073.00	1040.00	1006.00
259051	8' x 10'	17 lbs.	1106.00	1073.00	1040.00	1006.00
259053	9' Round	14 lbs.	1316.00	1277.00	1237.00	1198.00
259052	10' x 10'	22 lbs.	1316.00	1277.00	1237.00	1198.00

Setup fee: \$20(G)

Pricing is subject to change.

USD MSRP (C)

production lead time  
after final proof approval

# 3 DAYS

**PRICES ARE SUBJECT TO CHANGE.** No setup fee on orders placed via our website.

Visit [showdowndisplays.com](http://showdowndisplays.com) for current pricing, graphic templates, product videos and assembly instructions. See pages 288-291 for order details.

SHOWDOWNDISPLAYS.COM · ASI 87188 · PPAI 254687 · SAGE 67383 · PPPC 20101202

## STORM MAT



This water-absorbent mat makes a great first impression.

- Absorbs up to 1.5 gallons of liquid per square yard
- Easy to clean using a vacuum, steam cleaner or hose
- UV-resistant and treated with Stainstopper™
- Mat sizes are not exact; allow 3-5% size variance
- Art restrictions may apply, see page 288
- Not eligible for Rush Service

### Storm Mat

Item #	Description	Product Wt.	1	2-5	6-10	11-25
259030	2' x 3'	4 lbs.	406.50	333.25	288.75	276.50
259031	3' x 5'	10 lbs.	462.75	379.50	328.50	314.75
259032	4' x 6'	14 lbs.	587.00	481.25	416.75	399.00

Setup fee: \$20(G)

Pricing is subject to change.

USD MSRP (C)

Light colors show dirt easily and are not recommended for background colors. Item has limited number of available colors (56). We cannot guarantee color matching. Test strip/match print/test grid not available.



4' x 6'



Constructed of 65 mil nitrile rubber with needle-punched polyester carpet.

## FLOOR HUGGER MAT



Put quality designs right at your feet. The Floor Hugger mat features a nylon yarn surface with black rubber borders and backing.

- Treated with Stainstopper™ and static dissipative
- Will not crack or curl
- Produced with polyester PET yarn consisting of 100% post-consumer recycled content
- Mat sizes are not exact; allow 3-5% size variance
- Art restrictions may apply, see page 288
- Not eligible for Rush Service

### Floor Hugger Mat

Item #	Description	Product Wt.	1	2-5	6-10	11-25
259000	3' x 5'	8 lbs.	346.00	283.75	245.60	235.20
259001	3' x 10'	16 lbs.	568.00	465.75	403.25	386.25
259002	4' x 6'	12 lbs.	442.25	362.50	314.00	300.75

Setup fee: \$20(G)

Pricing is subject to change.

USD MSRP (C)

Light colors show dirt easily and are not recommended for background colors. Item has limited number of available colors (150). We cannot guarantee color matching. Test strip/match print/test grid not available.



4' x 6'



Mat features chemical-resistant plush carpet.

**PRICES ARE SUBJECT TO CHANGE.** No setup fee on orders placed via our website.

Visit [showdowndisplays.com](http://showdowndisplays.com) for current pricing, graphic templates, product videos and assembly instructions. See pages 288-291 for order details.

SHOWDOWNDISPLAYS.COM · ASI 87188 · PPAI 254687 · SAGE 67383 · PPPC 20101202

production lead time  
after final proof approval  
**7 DAYS**

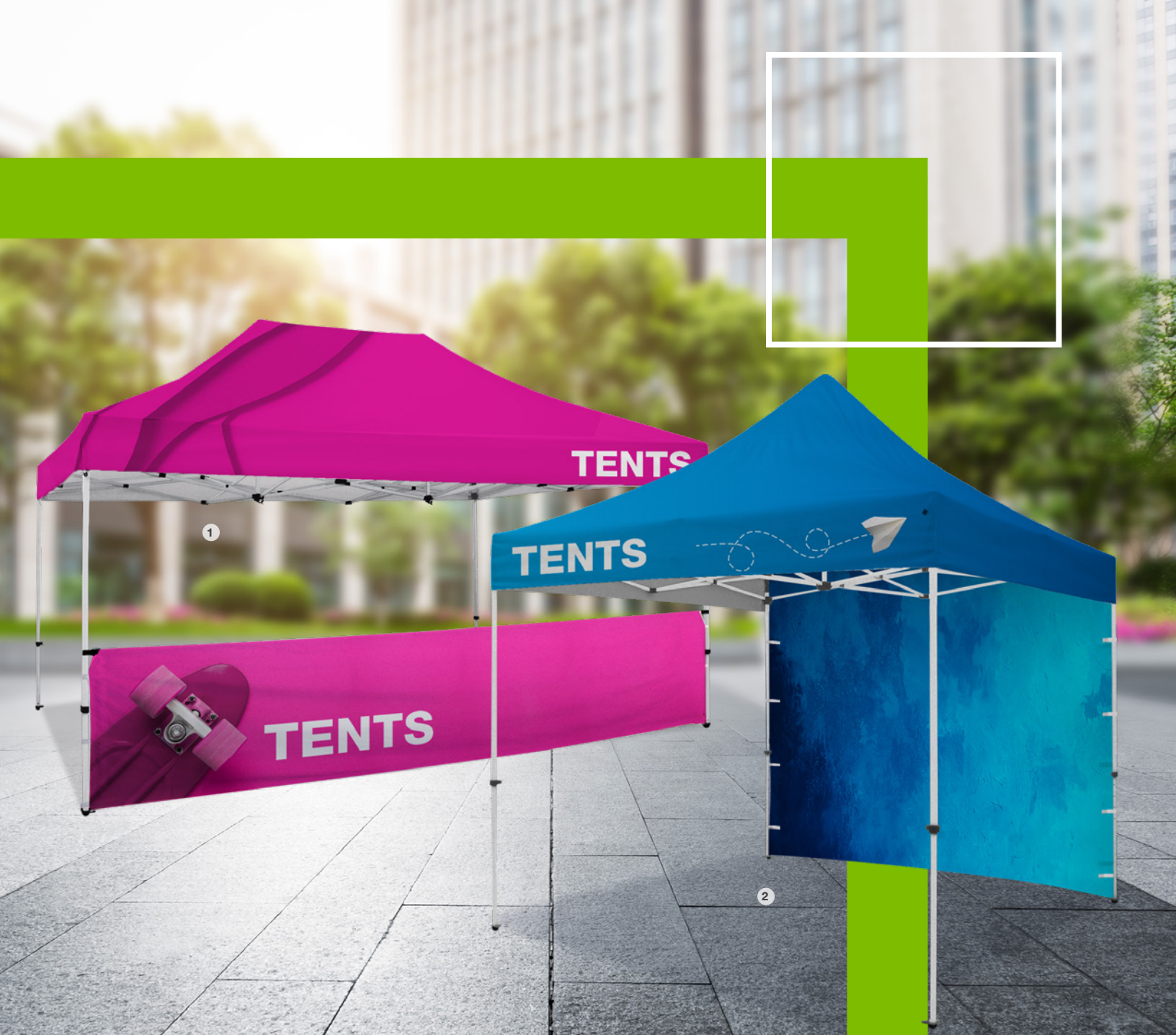

# TENTS

1. Premium 15' Tent with Half Wall pages 124 & 129 2. Standard 10' Tent with Full Wall pages 118 & 129

## have you considered...

- **location** where will this tent be used?
- **longevity** will you be using your tent for one or multiple events?
- **message** what is the desired impact of your promotional message?
- **weather** will you need additional reinforcement against wind?
- **accessories** would you like to add additional ad space?

## how to **DISPLAY**

Branded tents increase your visibility and brand recognition from a distance. Tents can provide shelter from the elements and define a space for specific activities; such as product displays, demonstrations or meetings. Perfect for outdoor events.

# TENT COMPARISON CHART

BEST SELLERS ★ 10' is our most popular size		FRAME/ CANOPY WARRANTY	FRAME CONSTRUCTION	FRAME WEIGHT	TOTAL SIZE	PRINT METHODS				
ECONOMY	PG #	FRAME / 600 DENIER / UV-PRINTING				FULL-COLOR IMPRINT	DYE SUBLIMATION	UV-PRINTING		
5' & 5' Plus	117	6 months / 1 year	 STEEL 1.1875\" W LEGS	0.9 mm white finish powder-coated steel · plastic release button for height adjustments · ABS nylon joints	32 lbs.	57.875\" W x 116.875\" -124.625\" H x 57.875\" D	online only	✓		
10' & 10' Plus	117				41.5 lbs.	117.5\" W x 128.75\" -136.5\" H x 117.5\" D	online only	✓		
STANDARD	PG #	FRAME / 600 DENIER / UV-PRINTING				FULL-COLOR IMPRINT	DYE SUBLIMATION	UV-PRINTING		
10' ★	118	Lifetime / 1 year / 3 years	 STEEL 1.125\" W LEGS	1 mm powder-coated steel · plastic push button for height adjustments · ABS nylon joints	36 lbs.	118.5\" W x 127.5\" -140\" H x 118.5\" D	✓	✓	✓	
10' Wall Kit	127								✓	
DELUXE	PG #	FRAME / 600 DENIER / UV-PRINTING				FULL-COLOR IMPRINT	DYE SUBLIMATION	UV-PRINTING		
6'	119	Lifetime / 1 year / 3 years	 STEEL 1.25\" W LEGS	1 mm powder-coated steel · lever for height adjustments · ABS glass-filled nylon joints	38.5 lbs.	72\" W x 109\" -121.5\" H x 72\" D		✓		
8' ★	119				44.5 lbs.	96\" W x 117.5\" -130\" H x 96\" D		✓		
10' ★	120				48 lbs.	118.5\" W x 127\" -139.5\" H x 118.5\" D	✓	✓	✓	
OMNI	PG #	FRAME / 600 DENIER / UV-PRINTING				FULL-COLOR IMPRINT	DYE SUBLIMATION	UV-PRINTING		
10'	122	Lifetime / 1 year / 3 years	 ALUMINUM 1.25\" DIA. OCTAGON LEGS	0.8 mm anodized aluminum frame · 1 mm powder-coated steel truss · lever for height adjustments · ABS glass-filled nylon joints	41.2 lbs.	119.5\" W x 115.25\" -126.875\" H x 119.5\" D	✓	✓	✓	
PREMIUM	PG #	FRAME / 600 DENIER / UV-PRINTING				FULL-COLOR IMPRINT	DYE SUBLIMATION	UV-PRINTING		
10' ★	123	Lifetime / 1 year / 3 years	 ALUMINUM 1.75\" DIA. HEXAGON LEGS	0.8 mm anodized aluminum · lever for height adjustments · ABS glass-filled nylon joints	36.5 lbs.	118\" W x 126.75\" -139.25\" H x 118\" D	✓	✓	✓	
10' Wall Kit	127								✓	
15'	124				46 lbs.	175.5\" W x 126.75\" -139.25\" H x 118.25\" D	✓	✓	✓	
20' ★	124				62.75 lbs.	234.5\" W x 126.75\" -139.25\" H x 118.25\" D	✓	✓	✓	
PREMIUM GABLE	PG #	FRAME / 600 DENIER / UV-PRINTING				FULL-COLOR IMPRINT	DYE SUBLIMATION	UV-PRINTING		
10'	125	Lifetime / 1 year	 ALUMINUM 1.75\" DIA. HEXAGON LEGS	0.8 mm anodized aluminum · lever for height adjustments · ABS glass-filled nylon joints	37.4 lbs.	118\" W x 119.25\" -131.5\" H x 118\" D	✓	✓		
15'	125				47.2 lbs.	175.5\" W x 119.25\" -131.75\" H x 118.25\" D	✓	✓		
20'	125				64 lbs.	234.5\" W x 119.25\" -131.75\" H x 118.25\" D	✓	✓		
ELITE	PG #	FRAME / 600 DENIER / UV-PRINTING				FULL-COLOR IMPRINT	DYE SUBLIMATION	UV-PRINTING		
10'	126	Lifetime / 1 year / 3 years	 ALUMINUM 2.125\" DIA. HEXAGON LEGS	1.55 mm anodized aluminum · lever for height adjustments · machined aluminum joints	63 lbs.	118\" W x 116.75\" -128.25\" H x 118\" D	✓	✓	✓	



**Beaufort Wind Rating: All tents have a wind rating of 5.**

See rating icon underneath the product name. Wind ratings were determined utilizing all available securing/stabilizing options sold with or offered for the product. See page 291 for details.

*Disclaimer: Wind rating conducted in a controlled environment. Outdoor products should be taken down if bad weather is likely; wind gusts or heavy rain could reduce the wind resistance of these products.*

## QUICK & EASY SETUP FEATURES



Sets up in minutes.



Adjust tent height with the push of a button.



Crank-up canopy creates a taut, clean peak. \*Excludes Economy, Elite & Omni tents.



Secure tent to the ground with stake kit.



Collapses easily to store in a rolling soft case with wheels. \*Excludes Economy & Omni tents.

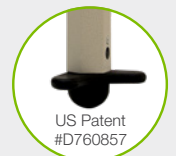

Easy-Glide Tent Feet for mobility.

# CANOPY PRINT METHODS

THREE OPTIONS AVAILABLE

## Choose Your Imprint Locations



One imprint per location (peak or valance).  
Maximum of four locations per tent.  
Only one setup fee per tent.



## FULL-COLOR IMPRINT

Imprinted on peak and/or valance locations of your choice.

- One imprint per location (peak or valance)
- Maximum imprint locations listed on individual pages
- Only one setup fee per tent
- 10' canopies are available in eight stock colors (see below); vented canopy available in white only
- Canopy is constructed of 600 denier polyester



## DYE SUBLIMATION

Covers the entire canopy with vibrant, full-color artwork.

- One piece per side for a continuous image from peak to valance with no seams (excludes Economy)
- Economy features a three-piece construction with separate pieces for the peak, valance and main body
- Artwork is vibrantly dye sublimated on 600 denier polyester
- Cannot guarantee graphic alignment across seams



## UV-PRINTED

Covers the entire canopy with vibrant, full-color artwork.\*

- One piece per side for a continuous image from peak to valance with no seams
- Internal corner seams for a seamless look
- Best fade resistance available with a three-year warranty
- Artwork is vibrantly printed on 600 denier polyester
- Cannot guarantee graphic alignment across seams
- Not eligible for Rush Service

\*Not available on Economy, 6' and 8' Deluxe, Premium Gable tents or vented canopies.



Full-color imprint and dye sublimated canopies have a one-year warranty.



UV-printed canopies have a three-year warranty.

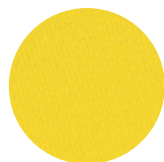

Constructed of durable 600 denier polyester.



Stock table throw colors closely align with stock tent colors; excludes Blaze Orange. See page 9.



Flame retardant certified for exhibit hall use.

## 10' CANOPY STOCK COLORS



WHITE

LEMON  
PMS 109

BLAZE ORANGE  
PMS 804

CHERRY  
PMS 1795

EMERALD  
PMS 347

COBALT  
PMS 7683

NAVY BLUE  
PMS 2767

BLACK

PMS colors are for reference only and may vary slightly from actual color.

**Economy Kit Includes:**



Stake Kit

**Economy Plus Kit Includes:**



Soft Carry Case with Wheels



Stake Kit



Spring-loaded center pole sets up quickly without a center pole crank.

**5' & 10' ECONOMY TENTS**



Ideal for short-term use, these Economy tents are where affordability and functionality meet.

- 1.1875"W square legs constructed of 0.9 mm white finish powder-coated steel
- ABS nylon joints
- Spring-loaded center pole allows for quick and easy peak setup
- 10' tents are compatible with Deluxe half wall kits; 5' Economy half wall kits available (see page 128)
- Canopy is available in full-bleed dye sublimation featuring three-piece construction with separate pieces for the peak, valance and main body
- Quick Ship available online for 1- or 2-location full-color imprint tent kits
- Economy Plus includes soft carry case with wheels

**Economy Tent**

Item #	Description	1	2-5	6-11	12-24
241300	5' Dye Sublimation Kit	423.50	415.00	406.50	393.75
241239	10' Dye Sublimation Kit	790.50	774.50	759.00	735.00

Setup fee: **\$20(G)**

Pricing is subject to change.

Soft Carry Case Not Included

USD MSRP (C)

Description	Product Size	Finished Graphic Size	Product Wt.
5'	57.875"W x 116.875"-124.625"H x 57.875"D	view online template	37 lbs.
10'	117.5"W x 128.75"-136.5"H x 117.5"D	view online template	51 lbs.

**Economy Plus Tent**

Item #	Description	1	2-5	6-11	12-24
241301	5' Dye Sublimation Kit	467.50	458.25	448.75	434.75
241240	10' Dye Sublimation Kit	925.50	907.00	888.50	860.50

Setup fee: **\$20(G)**

Pricing is subject to change.

USD MSRP (C)

Description	Product Size	Finished Graphic Size	Product Wt.
5'	57.875"W x 116.875"-124.625"H x 57.875"D	view online template	42.8 lbs.
10'	117.5"W x 128.75"-136.5"H x 117.5"D	view online template	56.8 lbs.



Easy-Glide Tent Feet allow the tent frame to slide on dirt and grass, preventing the legs from catching. US Patent #D760857



Legs feature plastic release buttons for easy height adjustments.

SHIPPING CASE: DOUBLE-WALL SHIPPING BOX.

**PRICES ARE SUBJECT TO CHANGE.** No setup fee on orders placed via our website. Visit [showdowndisplays.com](http://showdowndisplays.com) for current pricing, graphic templates, product videos and assembly instructions. See pages 288-291 for order details. SHOWDOWNDISPLAYS.COM · ASI 87188 · PPAI 254687 · SAGE 67383 · PPPC 20101202

production lead time after final proof approval  
**7 DAYS**

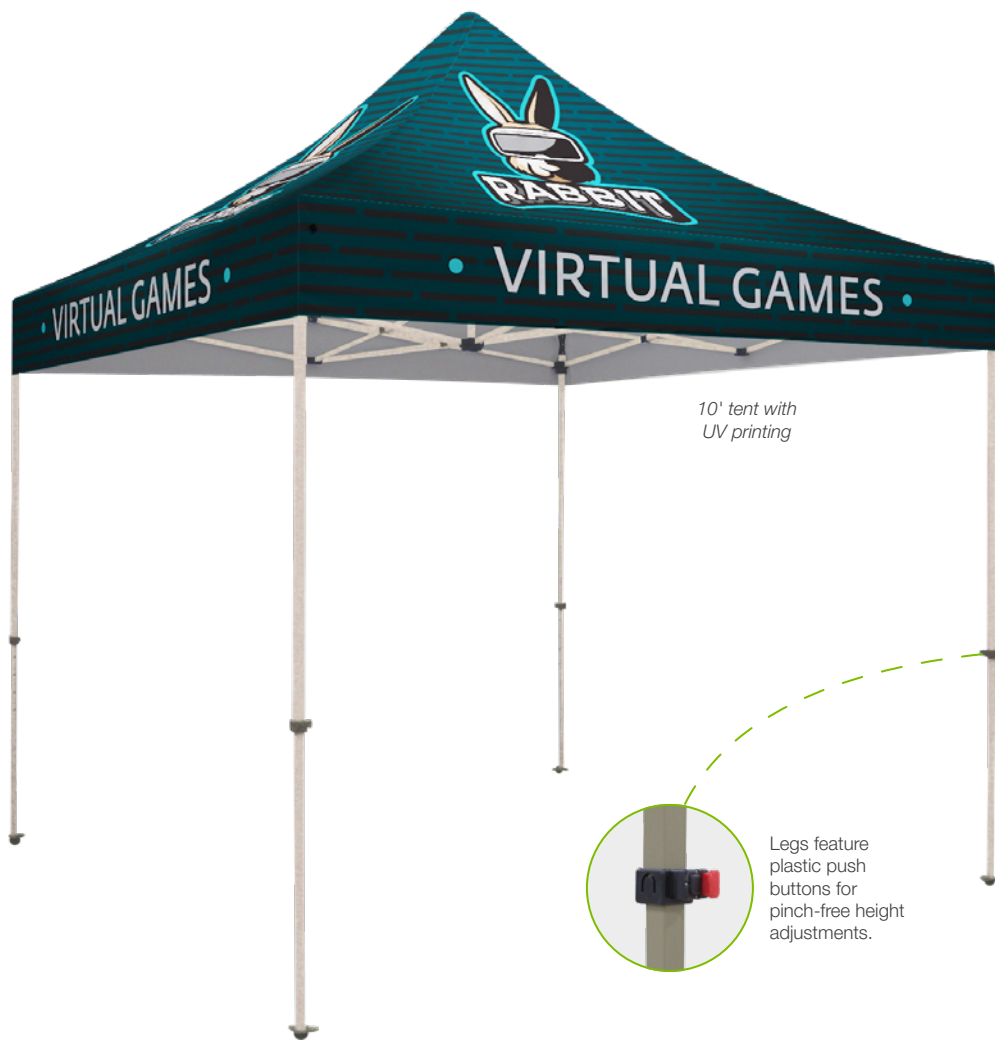

10' tent with UV printing

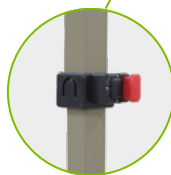

Legs feature plastic push buttons for pinch-free height adjustments.

**Kit Includes:**



Soft Carry Case with Wheels



Stake Kit



**10' STANDARD TENT**



This popular tent strikes a perfect balance between cost effectiveness and portability.

- 1.125"W square legs constructed of 1 mm pebble powder-coated steel
- ABS nylon joints
- Crank-up canopy creates a taut, clean peak
- Canopy available in eight stock colors (see page 116), with full-bleed dye sublimation or with full-bleed UV printing
- UV printing is not eligible for Rush Service

**10' Standard Tent**

Item #	Description	1	2-5	6-11	12-24
240611	Full-Color Imprint Kit (1 Location)	613.50	601.00	589.00	570.50
240612	Full-Color Imprint Kit (2 Locations)	681.50	668.00	654.50	634.00
240614	Full-Color Imprint Kit (4 Locations)	801.50	785.50	769.50	745.50
240619	Dye Sublimation Kit	1002.00	982.00	962.00	931.50
241420	UV-Printed Kit	1762.00	1727.00	1692.00	1639.00

Setup fee: \$20(G)

Pricing is subject to change.

USD MSRP (C)

Product Size: 118.5"W x 127.5"-140"H x 118.5"D  
 Finished Graphic Size: view online template  
 Product Wt.: 51.5 lbs.



Easy-Glide Tent Feet allow the tent frame to slide on dirt and grass, preventing the legs from catching. US Patent #D760857

IMPRINT DYE SUB UV-PRINTED production lead time after final proof approval  
**4-7-10 DAYS**

**SHIPPING CASE: DOUBLE-WALL SHIPPING BOX.**

**PRICES ARE SUBJECT TO CHANGE.** No setup fee on orders placed via our website.

Visit [showdowndisplays.com](http://showdowndisplays.com) for current pricing, graphic templates, product videos and assembly instructions. See pages 288-291 for order details.

SHOWDOWNDISPLAYS.COM · ASI 87188 · PPAI 254687 · SAGE 67383 · PPPC 20101202

**Kit Includes:**



Soft Carry Case with Wheels



Stake Kit



6'



8'

**6' & 8' DELUXE TENTS**



6' and 8' tents are compact enough for use indoors or in tight spaces.

- 1.25"W square legs constructed of 1 mm pebble powder-coated steel
- ABS glass-filled nylon joints
- Crank-up canopy creates a taut, clean peak
- Canopy is available with full-bleed dye sublimation

**6' Deluxe Tent**

Item #	Description	1	2-5	6-11	12-24
240809	Dye Sublimation Kit	979.50	960.00	940.50	911.00

**Setup fee: \$20(G)** Pricing is subject to change.  
USD MSRP (C)

Product Size	Finished Graphic Size	Product Wt.
72"W x 109"-121.5"H x 72"D	view online template	48.5 lbs.

**8' Deluxe Tent**

Item #	Description	1	2-5	6-11	12-24
240829	Dye Sublimation Kit	1667.00	1634.00	1600.00	1550.00

**Setup fee: \$20(G)** Pricing is subject to change.  
USD MSRP (C)

Product Size	Finished Graphic Size	Product Wt.
96"W x 117.5"-130"H x 96"D	view online template	58 lbs.



Easy-Glide Tent Feet allow the tent frame to slide on dirt and grass, preventing the legs from catching. US Patent #D760857



Legs feature levers for easy height adjustments.

SHIPPING CASE: DOUBLE-WALL SHIPPING BOX.

**PRICES ARE SUBJECT TO CHANGE.** No setup fee on orders placed via our website. Visit [showdowndisplays.com](http://showdowndisplays.com) for current pricing, graphic templates, product videos and assembly instructions. See pages 288-291 for order details.

SHOWDOWNDISPLAYS.COM · ASI 87188 · PPAI 254687 · SAGE 67383 · PPPC 20101202

production lead time after final proof approval  
**7 DAYS**



10' tent with UV printing



Legs feature levers for easy height adjustments.

**Kit Includes:**



Soft Carry Case with Wheels



Stake Kit



**10' DELUXE TENT**



Designed for frequent use, this tent features a stronger, heavier steel frame than that of the Standard.

- 1.25"W square legs constructed of 1 mm pebble powder-coated steel
- ABS glass-filled nylon joints
- Crank-up canopy creates a taut, clean peak
- Canopy available in eight stock colors (see page 116), with full-bleed dye sublimation or with full-bleed UV printing
- UV printing is not eligible for Rush Service

**10' Deluxe Tent**

Item #	Description	1	2-5	6-11	12-24
240621	Full-Color Imprint Kit (1 Location)	734.00	719.50	704.50	682.50
240622	Full-Color Imprint Kit (2 Locations)	802.50	786.00	770.00	746.00
240624	Full-Color Imprint Kit (4 Locations)	922.00	903.50	885.00	857.50
240629	Dye Sublimation Kit	1122.00	1100.00	1078.00	1044.00
241421	UV-Printed Kit	1883.00	1845.00	1808.00	1751.00

Setup fee: \$20(G)

Pricing is subject to change.

USD MSRP (C)

Product Size: 118.5"W x 127"-139.5"H x 118.5"D  
 Finished Graphic Size: view online template  
 Product Wt.: 63.5 lbs.



Easy-Glide Tent Feet allow the tent frame to slide on dirt and grass, preventing the legs from catching. US Patent #D760857

IMPRINT DYE SUB UV-PRINTED production lead time after final proof approval  
**4-7-10 DAYS**

**SHIPPING CASE: DOUBLE-WALL SHIPPING BOX.**

**PRICES ARE SUBJECT TO CHANGE.** No setup fee on orders placed via our website.

Visit [showdowndisplays.com](http://showdowndisplays.com) for current pricing, graphic templates, product videos and assembly instructions. See pages 288-291 for order details.

SHOWDOWNDISPLAYS.COM · ASI 87188 · PPAI 254687 · SAGE 67383 · PPPC 20101202

**Kit Includes:**



Soft Carry Case with Wheels



Stake Kit

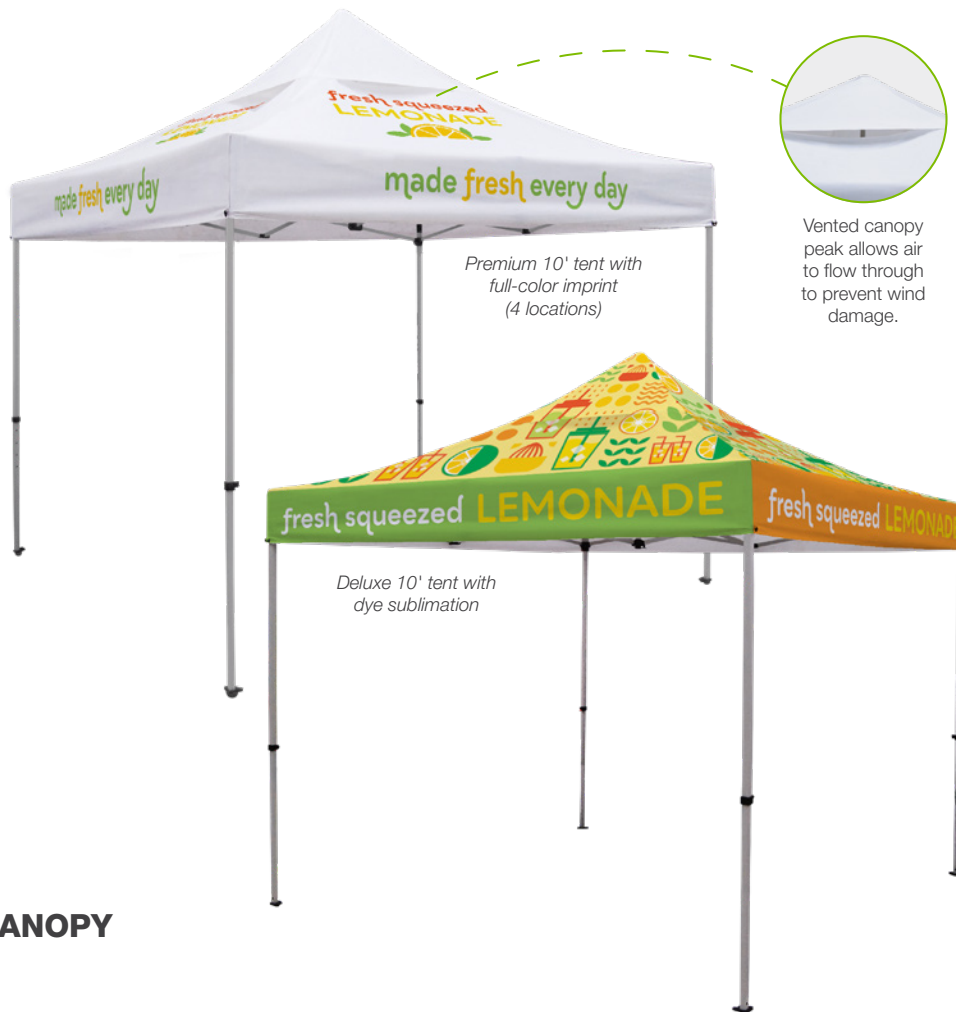

Premium 10' tent with full-color imprint (4 locations)

Vented canopy peak allows air to flow through to prevent wind damage.

Deluxe 10' tent with dye sublimation

**10' TENT WITH VENTED CANOPY**



These tents feature a vented canopy to keep them stable when the wind picks up.

- Canopy available in white only or full-bleed dye sublimation
- Crank-up canopy creates a taut, clean peak
- Choose Deluxe or Premium tent hardware (see pages 120 and 123 for hardware details)

**10' Deluxe Tent with Vented Canopy**

Item #	Description	1	2-5	6-11	12-24
240351	Full-Color Imprint Kit (1 Location)	787.00	771.50	755.50	732.00
240352	Full-Color Imprint Kit (2 Locations)	835.00	818.50	801.50	776.50
240354	Full-Color Imprint Kit (4 Locations)	932.00	913.50	894.50	866.50
241340	Dye Sublimation Kit	1228.00	1203.00	1178.00	1142.00

Setup fee: \$20(G)

Pricing is subject to change.

USD MSRP (C)

Product Size	Finished Graphic Size	Product Wt.
118.5"W x 127"-139.5"H x 118.5"D	view online template	63.5 lbs.

**10' Premium Tent with Vented Canopy**

Item #	Description	1	2-5	6-11	12-24
240411	Full-Color Imprint Kit (1 Location)	872.00	854.50	837.00	811.00
240412	Full-Color Imprint Kit (2 Locations)	920.00	901.50	883.00	855.50
240414	Full-Color Imprint Kit (4 Locations)	1017.00	996.50	976.00	945.50
241341	Dye Sublimation Kit	1312.00	1286.00	1260.00	1221.00

Setup fee: \$20(G)

Pricing is subject to change.

USD MSRP (C)

Product Size	Finished Graphic Size	Product Wt.
118"W x 126.75"-139.25"H x 118"D	view online template	52 lbs.



Easy-Glide Tent Feet allow the tent frame to slide on dirt and grass, preventing the legs from catching. US Patent #D760857

SHIPPING CASE: DOUBLE-WALL SHIPPING BOX.

PRICES ARE SUBJECT TO CHANGE. No setup fee on orders placed via our website.

Visit showdowndisplays.com for current pricing, graphic templates, product videos and assembly instructions. See pages 288-291 for order details.

SHOWDOWNDISPLAYS.COM · ASI 87188 · PPAI 254687 · SAGE 67383 · PPPC 20101202

IMPRINT DYE SUB production lead time after final proof approval

**4-7 DAYS**



**Kit Includes:**



Soft Case



Stake Kit



The frame's central hub design maximizes head space underneath the canopy.

Tent wheels make moving a breeze whether it's in use or being transported to your event.

**10' OMNI TENT**



This tent is designed for portability. It features an innovative central hub design that makes it a snap to set up.

- 1.25" diameter octagon legs constructed of 0.8 mm anodized aluminum
- Canopy is constructed of durable, weather-resistant 600 denier polyester
- Hybrid construction with aluminum legs and steel truss
- The included soft case slides over the frame when it's fully collapsed
- The tent can be secured to the ground with the included stake kit
- Frame must be secured to the ground to prevent wind damage (failure to secure the tent voids the warranty)
- Canopy available in eight stock colors (see page 116), with full-bleed dye sublimation or with full-bleed UV printing
- UV printing is not eligible for Rush Service



Easy-Glide Tent Feet allow the tent frame to slide on dirt and grass, preventing the legs from catching. US Patent #D760857



Legs feature levers for easy height adjustments.

**10' Omni Tent**

Item #	Description	1	2-5	6-11	12-24
241271	Full-Color Imprint Kit (1 Location)	969.50	950.00	930.50	901.50
241272	Full-Color Imprint Kit (2 Locations)	1038.00	1017.00	996.00	965.00
241274	Full-Color Imprint Kit (4 Locations)	1157.00	1134.00	1111.00	1076.00
241279	Dye Sublimation Kit	1540.00	1509.00	1478.00	1432.00
241425	UV-Printed Kit	2118.00	2076.00	2034.00	1970.00

**Setup fee: \$20(G)**

**Pricing is subject to change.**

USD MSRP (C)

**Product Size** 119.5"W x 115.25"H x 126.875"D **Finished Graphic Size** view online template **Product Wt.** 52.5 lbs.

IMPRINT DYE SUB UV-PRINTED production lead time after final proof approval  
**4-7-10 DAYS**

**PRICES ARE SUBJECT TO CHANGE.** No setup fee on orders placed via our website. Visit [showdowndisplays.com](http://showdowndisplays.com) for current pricing, graphic templates, product videos and assembly instructions. See pages 288-291 for order details.

SHOWDOWNDISPLAYS.COM · ASI 87188 · PPAI 254687 · SAGE 67383 · PPPC 20101202

**Kit Includes:**



Soft Carry Case with Wheels



Stake Kit



10' tent shown in lemon with full-color imprint (4 locations)

Legs feature levers for easy height adjustments.

**10' PREMIUM TENT**



This Premium tent features a strong aluminum frame with sturdy hexagon-shaped legs.

- 1.75" diameter hexagon-shaped legs constructed of 0.8 mm anodized aluminum
- ABS glass-filled nylon joints
- Crank-up canopy creates a taut, clean peak
- Canopy available in eight stock colors (see page 116), with full-bleed dye sublimation or with full-bleed UV printing
- UV printing is not eligible for Rush Service

**10' Premium Tent**

Item #	Description	1	2-5	6-11	12-24
240631	Full-Color Imprint Kit (1 Location)	819.00	802.50	786.00	761.50
240632	Full-Color Imprint Kit (2 Locations)	887.00	869.50	851.50	825.00
240634	Full-Color Imprint Kit (4 Locations)	1007.00	986.50	966.50	936.50
240639	Dye Sublimation Kit	1207.00	1183.00	1159.00	1123.00
241422	UV-Printed Kit	1968.00	1928.00	1889.00	1830.00

Setup fee: \$20(G)

Pricing is subject to change.

USD MSRP (C)

Product Size  
118"W x 126.75"-139.25"H x 118"D

Finished Graphic Size  
view online template

Product Wt.  
52 lbs.



Easy-Glide Tent Feet allow the tent frame to slide on dirt and grass, preventing the legs from catching. US Patent #D760857

**PRICES ARE SUBJECT TO CHANGE.** No setup fee on orders placed via our website. Visit [showdowndisplays.com](http://showdowndisplays.com) for current pricing, graphic templates, product videos and assembly instructions. See pages 288-291 for order details. SHOWDOWNDISPLAYS.COM · ASI 87188 · PPAI 254687 · SAGE 67383 · PPPC 20101202

IMPRINT DYE SUB UV-PRINTED production lead time after final proof approval  
**4-7-10 DAYS**



15' tent with UV printing



20' tent shown in white with full-color imprint (12 locations)

**Kit Includes:**



Soft Carry Case with Wheels



Stake Kit

**15' & 20' PREMIUM TENTS**



Our two largest tent sizes give you ample space for displaying your products, serving refreshments or just keeping out of the sun.

- 1.75" diameter hexagon legs constructed of 0.8 mm anodized aluminum
- ABS glass-filled nylon joints
- Crank-up canopy creates a taut, clean peak
- Canopy available in five stock colors, with full-bleed dye sublimation or with full-bleed UV printing
- UV printing is not eligible for Rush Service

**Stock 15' & 20' Canopy Colors**

- White
- Navy Blue PMS 2767
- Cherry PMS 1795
- Black
- Cobalt PMS 7683

*PMS colors are for reference only and may vary slightly from actual color.*



Easy-Glide Tent Feet allow the tent frame to slide on dirt and grass, preventing the legs from catching. US Patent #D760857



Legs feature levers for easy height adjustments.

**10' x 15' Premium Tent**

Item #	Description	1	2-5	6-11	12-24
240550	Unimprinted Kit	1055.00	1034.00	1013.00	981.00
240551	Full-Color Imprint Kit (1 Location)	1145.00	1122.00	1099.00	1065.00
240552	Full-Color Imprint Kit (2 Locations)	1235.00	1211.00	1186.00	1149.00
240554	Full-Color Imprint Kit (4 Locations)	1345.00	1318.00	1291.00	1251.00
240556	Full-Color Imprint Kit (6 Locations)	1438.00	1409.00	1380.00	1337.00
240558	Full-Color Imprint Kit (8 Locations)	1529.00	1498.00	1468.00	1422.00
240560	Full-Color Imprint Kit (10 Locations)	1630.00	1598.00	1565.00	1516.00
240562	Full-Color Imprint Kit (12 Locations)	1634.00	1601.00	1568.00	1519.00
240563	Dye Sublimation Kit	2055.00	2014.00	1973.00	1911.00
241430	UV-Printed Kit	2088.00	2046.00	2004.00	1942.00

Setup fee: \$20(G)

Pricing is subject to change.

USD MSRP (C)

Product Size	Finished Graphic Size	Product Wt.
175.5"W x 126.75"-139.25"H x 118.25"D	view online template	70.5 lbs.

**10' x 20' Premium Tent**

Item #	Description	1	2-5	6-11	12-24
240570	Unimprinted Kit	1227.00	1202.00	1178.00	1141.00
240571	Full-Color Imprint Kit (1 Location)	1278.00	1253.00	1227.00	1189.00
240572	Full-Color Imprint Kit (2 Locations)	1349.00	1322.00	1295.00	1255.00
240574	Full-Color Imprint Kit (4 Locations)	1585.00	1553.00	1521.00	1474.00
240576	Full-Color Imprint Kit (6 Locations)	1780.00	1744.00	1708.00	1655.00
240578	Full-Color Imprint Kit (8 Locations)	1882.00	1844.00	1807.00	1750.00
240580	Full-Color Imprint Kit (10 Locations)	1902.00	1864.00	1826.00	1769.00
240582	Full-Color Imprint Kit (12 Locations)	1905.00	1867.00	1829.00	1772.00
240583	Dye Sublimation Kit	2532.00	2481.00	2431.00	2355.00
241431	UV-Printed Kit	2421.00	2372.00	2324.00	2251.00

Setup fee: \$20(G)

Pricing is subject to change.

USD MSRP (C)

Product Size	Finished Graphic Size	Product Wt.
234.5"W x 126.75"-139.25"H x 118.25"D	view online template	92 lbs.

**UNIMPRINTED CANOPY LEAD TIME: SHIPS SAME DAY WHEN ORDERED BEFORE 2 PM CENTRAL**

**PRICES ARE SUBJECT TO CHANGE.** No setup fee on orders placed via our website.

Visit [showdowndisplays.com](http://showdowndisplays.com) for current pricing, graphic templates, product videos and assembly instructions. See pages 288-291 for order details.

SHOWDOWNDISPLAYS.COM · ASI 87188 · PPAI 254687 · SAGE 67383 · PPPC 20101202

IMPRINT DYE SUB UV-PRINTED production lead time after final proof approval  
**4-7-10 DAYS**

**Kit Includes:**



Soft Carry Case with Wheels



Stake Kit



10' tent with dye sublimation



Center poles crank up to create a taut gable shape.

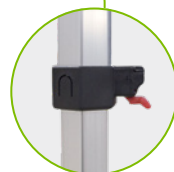

Legs feature levers for easy height adjustments.

**10' x 10' Premium Gable Tent**

Item #	Description	1	2-5	6-11	12-24
241121	Full-Color Imprint Kit (1 Location)	1143.00	1120.00	1097.00	1063.00
241122	Full-Color Imprint Kit (2 Locations)	1233.00	1208.00	1183.00	1146.00
241124	Full-Color Imprint Kit (4 Locations)	1413.00	1385.00	1357.00	1314.00
241129	Dye Sublimation Kit	1975.00	1936.00	1896.00	1837.00

Setup fee: \$20(G)

Pricing is subject to change.  
USD MSRP (C)

**10' x 15' Premium Gable Tent**

Item #	Description	1	2-5	6-11	12-24
241130	Unimprinted Kit	1151.00	1128.00	1105.00	1071.00
241131	Full-Color Imprint Kit (1 Location)	1467.00	1438.00	1408.00	1364.00
241132	Full-Color Imprint Kit (2 Locations)	1562.00	1531.00	1499.00	1453.00
241134	Full-Color Imprint Kit (4 Locations)	1719.00	1684.00	1650.00	1598.00
241136	Full-Color Imprint Kit (6 Locations)	1776.00	1740.00	1705.00	1652.00
241138	Full-Color Imprint Kit (8 Locations)	1817.00	1780.00	1744.00	1689.00
241140	Full-Color Imprint Kit (10 Locations)	1958.00	1919.00	1880.00	1821.00
241142	Full-Color Imprint Kit (12 Locations)	1983.00	1944.00	1904.00	1845.00
241143	Dye Sublimation Kit	1911.00	1873.00	1835.00	1777.00

Setup fee: \$20(G)

Pricing is subject to change.  
USD MSRP (C)

**10' x 20' Premium Gable Tent**

Item #	Description	1	2-5	6-11	12-24
241170	Unimprinted Kit	1619.00	1587.00	1554.00	1506.00
241171	Full-Color Imprint Kit (1 Location)	1709.00	1675.00	1641.00	1590.00
241172	Full-Color Imprint Kit (2 Locations)	1798.00	1763.00	1727.00	1673.00
241174	Full-Color Imprint Kit (4 Locations)	1978.00	1939.00	1899.00	1840.00
241176	Full-Color Imprint Kit (6 Locations)	2191.00	2147.00	2103.00	2037.00
241178	Full-Color Imprint Kit (8 Locations)	2357.00	2310.00	2262.00	2192.00
241180	Full-Color Imprint Kit (10 Locations)	2550.00	2499.00	2448.00	2372.00
241182	Full-Color Imprint Kit (12 Locations)	2731.00	2676.00	2621.00	2540.00
241183	Dye Sublimation Kit	2950.00	2891.00	2832.00	2743.00

Setup fee: \$20(G)

Pricing is subject to change.  
USD MSRP (C)

Description	Product Size	Finished Graphic Size	Product Wt.
10'	118"W x 119.25"-131.75"H x 118"D	view online template	55 lbs.
15'	175.5"W x 119.25"-131.75"H x 118.25"D	view online template	70.5 lbs.
20'	234.5"W x 119.25"-131.75"H x 118.25"D	view online template	91.5 lbs.

**10', 15' & 20' PREMIUM GABLE TENTS**



These tents stand out from the crowd with a unique gable shape, allowing for more visible space to share your message.

- Available in 10', 15' and 20' sizes
- 1.75" diameter hexagon legs constructed of 0.8 mm anodized aluminum
- ABS glass-filled nylon joints
- 10' x 10' tents have three center poles, 10' x 15' have four center poles and 10' x 20' have five center poles
- 10' canopy available in eight stock colors (see page 116) or with full-bleed dye sublimation
- 15' and 20' canopies available in white or with full-bleed dye sublimation



Easy-Glide Tent Feet allow the tent frame to slide on dirt and grass, preventing the legs from catching. US Patent #D760857

UNIMPRINTED CANOPY LEAD TIME: SHIPS SAME DAY WHEN ORDERED BEFORE 2 PM CENTRAL

PRICES ARE SUBJECT TO CHANGE. No setup fee on orders placed via our website.

Visit showdowndisplays.com for current pricing, graphic templates, product videos and assembly instructions. See pages 288-291 for order details.

SHOWDOWNDISPLAYS.COM · ASI 87188 · PPAI 254687 · SAGE 67383 · PPPC 20101202

IMPRINT DYE SUB production lead time after final proof approval

**4-7 DAYS**



10' tent with UV printing



Legs feature levers for easy height adjustments.

**Kit Includes:**



Soft Carry Case with Wheels



Stake Kit

**10' ELITE TENT**



The Elite tent features our strongest, most robust frame and adds a professional touch to any event.

- 2.125" diameter hexagon-shaped legs constructed of 1.55 mm anodized aluminum
- Machined aluminum joints
- Self-adjusting spring tension frame creates a taut, clean canopy peak
- Compatible with Tent Sandbag Ballasts (see page 127); not compatible with Square Plastic Water Weight and Steel Ballast Weight
- Canopy available in eight stock colors (see page 116), with full-bleed dye sublimation or with full-bleed UV printing
- UV printing is not eligible for Rush Service

**10' Elite Tent**

Item #	Description	1	2-5	6-11	12-24
240981	Full-Color Imprint Kit (1 Location)	1592.00	1560.00	1528.00	1480.00
240982	Full-Color Imprint Kit (2 Locations)	1660.00	1627.00	1593.00	1544.00
240984	Full-Color Imprint Kit (4 Locations)	1914.00	1876.00	1838.00	1780.00
240989	Dye Sublimation Kit	2115.00	2073.00	2030.00	1967.00
241423	UV-Printed Kit	2875.00	2818.00	2760.00	2674.00

Setup fee: \$20(G)

Pricing is subject to change.

USD MSRP (C)

Product Size  
118"W x 116.75"H x 128.25"D

Finished Graphic Size  
view online template

Product Wt.  
78.5 lbs.

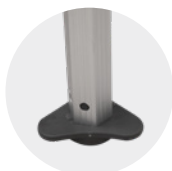

Easy-Glide Tent Feet allow the tent frame to slide on dirt and grass, preventing the legs from catching. US Patent #D760857

IMPRINT DYE SUB UV-PRINTED production lead time after final proof approval  
4 -OR- 7 -OR- 10 DAYS

SHIPPING CASE: DOUBLE-WALL SHIPPING BOX.

PRICES ARE SUBJECT TO CHANGE. No setup fee on orders placed via our website.

Visit showdowndisplays.com for current pricing, graphic templates, product videos and assembly instructions. See pages 288-291 for order details.

SHOWDOWNDISPLAYS.COM · ASI 87188 · PPAI 254687 · SAGE 67383 · PPPC 20101202

**Kit Includes:**



Soft Carry Case with Wheels



Stake Kit

**10' TENT AND WALL KIT**



This tent kit features everything you need for a full tent setup. Includes a frame, canopy, full wall and two half wall stabilizer bar kits for a three-sided marketing space.

- Available in 600 denier polyester
- Canopy and walls are printed with full-bleed dye sublimation
- Walls are single-sided and can be applied facing inward or outward



10' Standard tent and wall kit

**10' Tent and Wall Kit**

Item #	Description	1	2-5	6-11	12-24
241400	10' Standard Dye Sublimation Kit	1965.00	1926.00	1886.00	1827.00
241401	10' Premium Dye Sublimation Kit	2187.00	2143.00	2100.00	2034.00

Setup fee: \$20(G)

Pricing is subject to change.

USD MSRP (C)

Description	Product Size	Finished Graphic Size	Product Wt.
standard	118.5"W x 127.5"-140"H x 118.5"D	view online template	66.2 lbs.
premium	118"W x 126.75"-139.25"H x 118"D	view online template	60 lbs.



Wall art will be printed on outward-facing side unless otherwise requested.

**TENT ACCESSORIES**



**Tent Accessories**

Item #	Description	Product Wt.	1	2-5	6-11	12-24
220079	10' Tent Soft Case with Wheels	5.8 lbs.	134.90	132.20	129.50	125.50
220150	10' or 15' Tent Hard Case with Wheels	22 lbs.	371.00	363.50	356.25	345.00
220080	15' or 20' Tent Soft Case with Wheels	8.2 lbs.	186.30	182.60	178.90	173.30
150122	LED Tent Light Kit	0.8 lb.	90.00	88.20	86.40	83.70
240085	Square Plastic Water Weight*	22 lbs. w/ water	54.30	53.20	52.10	50.50
240094	Steel Ballast Weight*	11 lbs.	74.25	72.75	71.30	69.05
240112	Tent Sandbag Ballast (Set of 4)	20.6 lbs. w/ sand	81.60	80.00	78.35	75.90
240015	Tent Stake Kit	1 lb.	39.11	38.33	37.55	36.37

Pricing is subject to change.

USD MSRP (C)

\*Not Compatible with Elite tent frame



Item #150122  
LED tent light kit



Item #240015  
Tent stake kit



Item #240094  
Steel ballast weight



Item #240085  
Square plastic water weight



Item #240112  
Tent sandbag ballast



Item #220079  
10' soft case with wheels



Item #220150  
Hard case with wheels

**HARDWARE-ONLY LEAD TIME: SHIPS SAME DAY WHEN ORDERED BEFORE 2 PM CENTRAL**  
**PRICES ARE SUBJECT TO CHANGE.** No setup fee on orders placed via our website.  
 Visit [showdowndisplays.com](http://showdowndisplays.com) for current pricing, graphic templates, product videos and assembly instructions. See pages 288-291 for order details.  
 SHOWDOWNDISPLAYS.COM · ASI 87188 · PPAI 254687 · SAGE 67383 · PPPC 20101202

production lead time  
after final proof approval  
**7 DAYS**



## TENT WALLS



With several creative options to choose from, you can customize your tent for a truly unique look.

- Available in 600 denier polyester
- Walls can be applied facing inward or outward
- Single-sided art will be printed on outward-facing side unless otherwise requested
- Tent frame and canopy sold separately
- Economy 10' tents are compatible with Deluxe half wall hardware
- UV printing is not eligible for Rush Service

### 5' Economy Tent Frame Half Wall Kits

Item #	Description	1	2-5	6-11	12-24
241314	5' Half Wall Kit (Unimprinted)	121.00	118.60	116.20	112.50
241315	5' Half Wall Kit (Full-Color Imprint)	165.00	161.70	158.40	153.50
241316	5' Half Wall Kit (Dye Sublimation)	357.50	350.25	343.25	332.50
241317	5' Double-Sided Half Wall Kit (Dye Sublimation)	467.50	458.25	448.75	434.75

**Imprinted wall setup fee: \$20(G)**

Kit Includes: Half Wall, Stabilizing Bar and 2 Clamps

**Pricing is subject to change.**

USD MSRP (C)



10' half wall kit with full-color imprint

### Standard Tent Frame Half Wall Kits

Item #	Description	1	2-5	6-11	12-24
240336	10' Half Wall Kit (Unimprinted)	144.40	141.50	138.70	134.30
240339	10' Half Wall Kit (Full-Color Imprint)	233.50	228.90	224.20	217.20
240342	10' Half Wall Kit (Dye Sublimation)	259.00	253.75	248.70	240.90
240375	10' Double-Sided Half Wall Kit (Dye Sublimation)	469.25	459.75	450.50	436.25
241470	10' Half Wall Kit (UV-Printed)	254.25	249.60	245.00	238.10
241471	10' Double-Sided Half Wall Kit (UV-Printed)	506.50	496.50	487.00	472.50

**Imprinted wall setup fee: \$20(G)**

Kit Includes: Half Wall, Stabilizing Bar and 2 Clamps

**Pricing is subject to change.**

USD MSRP (C)

### Deluxe Tent Frame Half Wall Kits

Item #	Description	1	2-5	6-11	12-24
240856	6' Half Wall Kit (Dye Sublimation)	179.60	176.00	172.40	167.10
240857	6' Double-Sided Half Wall Kit (Dye Sublimation)	321.50	315.00	308.50	299.00
240886	8' Half Wall Kit (Dye Sublimation)	354.00	346.75	339.75	329.25
240887	8' Double-Sided Half Wall Kit (Dye Sublimation)	369.50	362.25	354.75	343.75
240337	10' Half Wall Kit (Unimprinted)	144.40	141.50	138.70	134.30
240340	10' Half Wall Kit (Full-Color Imprint)	233.50	228.90	224.20	217.20
240343	10' Half Wall Kit (Dye Sublimation)	259.00	253.75	248.70	240.90
240376	10' Double-Sided Half Wall Kit (Dye Sublimation)	469.25	459.75	450.50	436.25
241472	10' Half Wall Kit (UV-Printed)	255.75	251.00	246.50	239.50
241473	10' Double-Sided Half Wall Kit (UV-Printed)	508.00	498.00	488.50	474.00

**Imprinted wall setup fee: \$20(G)**

Kit Includes: Half Wall, Stabilizing Bar and 2 Clamps

**Pricing is subject to change.**

USD MSRP (C)

### Omni Tent Frame Half Wall Kits

Item #	Description	1	2-5	6-11	12-24
240306	10' Half Wall Kit (Unimprinted)	130.50	127.90	125.20	121.30
240307	10' Half Wall Kit (Full-Color Imprint)	219.60	215.20	210.80	204.20
240308	10' Half Wall Kit (Dye Sublimation)	245.10	240.20	235.30	227.90
240309	10' Double-Sided Half Wall Kit (Dye Sublimation)	455.25	446.00	437.00	423.25
241476	10' Half Wall Kit (UV-Printed)	282.00	276.25	270.75	262.25
241477	10' Double-Sided Half Wall Kit (UV-Printed)	534.00	523.50	512.50	496.75

**Imprinted wall setup fee: \$20(G)**

Kit Includes: Half Wall and Stabilizing Bar

**Pricing is subject to change.**

USD MSRP (C)

#### Half Wall Stock Colors

○ White ● Black

15' walls available in white only



10' half wall kit with dye sublimation

10' half wall kit with UV printing

### 90° Connector Clamp

Item #	Description	1	2-5	6-11	12-24
240192	Standard Frame Connector Clamp	14.98	14.68	14.38	13.93
240193	Deluxe Frame Connector Clamp	14.98	14.68	14.38	13.93
240194	Premium Frame Connector Clamp	14.98	14.68	14.38	13.93

**Pricing is subject to change.**

USD MSRP (C)

#### Add-On

90° connector clamp connects two stabilizing bars to keep half walls at the same level.



### Premium Tent Frame Half Wall Kits

Item #	Description	1	2-5	6-11	12-24
240338	10' Half Wall Kit (Unimprinted)	141.50	138.60	135.80	131.60
240341	10' Half Wall Kit (Full-Color Imprint)	230.80	226.20	221.50	214.60
240344	10' Half Wall Kit (Dye Sublimation)	256.00	251.00	245.80	238.20
240377	10' Double-Sided Half Wall Kit (Dye Sublimation)	466.50	457.00	447.75	433.75
241474	10' Half Wall Kit (UV-Printed)	265.75	261.00	256.25	248.90
241475	10' Double-Sided Half Wall Kit (UV-Printed)	518.00	508.00	498.00	483.25
240515	15' Half Wall Kit (Unimprinted)	171.90	168.50	165.10	159.90
240516	15' Half Wall Kit (Full-Color Imprint)	349.75	342.75	335.75	325.25
240517	15' Half Wall Kit (Dye Sublimation)	315.75	309.50	303.00	293.50
241480	15' Half Wall Kit (UV-Printed)	378.50	371.00	363.50	352.00

**Imprinted wall setup fee: \$20(G)**

Kit Includes: Half Wall, Stabilizing Bar and 2 Clamps

**Pricing is subject to change.**

USD MSRP (C)

### Elite Tent Frame Half Wall Kits

Item #	Description	1	2-5	6-11	12-24
240564	10' Half Wall Kit (Unimprinted)	152.50	149.40	146.40	141.80
240565	10' Half Wall Kit (Full-Color Imprint)	241.80	236.90	232.10	224.90
240566	10' Half Wall Kit (Dye Sublimation)	267.00	261.75	256.50	248.40
240567	10' Double-Sided Half Wall Kit (Dye Sublimation)	477.50	467.75	458.25	444.00
241478	10' Half Wall Kit (UV-Printed)	290.75	285.00	279.25	270.50
241479	10' Double-Sided Half Wall Kit (UV-Printed)	543.00	532.00	521.00	505.00

**Imprinted wall setup fee: \$20(G)**

Kit Includes: Half Wall, Stabilizing Bar and 2 Clamps

**Pricing is subject to change.**

USD MSRP (C)

Description	Product Size	Finished Graphic Size	Product Wt. (Imprint / Full-Bleed / Double-Sided)
5'	58.125"W x 38"H x 2.625"D	view online template	2.4 lbs. / 2.6 lbs. / 3.6 lbs.
6'	72"W x 38"H x 2.25"D	view online template	NA / 4.75 lbs. / 6.25 lbs.
8'	96"W x 38"H x 2.25"D	view online template	NA / 5.25 lbs. / 7.25 lbs.
10'	118"W x 38"H x 2.5"D	view online template	4.75 lbs. / 5.25 lbs. / 7.25 lbs.
10' Elite	118.5"W x 38"H x 3"D	view online template	4.5 lbs. / 5 lbs. / 7 lbs.
10' Omni	115.375"W x 38"H x 3"D	view online template	4.5 lbs. / 8.25 lbs. / 10.25 lbs.
15'	175.5"W x 38"H x 2.5"D	view online template	7.2 lbs. / 7.8 lbs. / NA

### Full Tent Walls

Item #	Description	1	2-5	6-11	12-24
241318	5' Full Wall (Unimprinted)	170.50	167.10	163.70	158.60
241319	5' Full Wall (Full-Color Imprint)	286.00	280.25	274.50	266.00
241320	5' Full Wall (Dye Sublimation)	330.00	323.50	316.75	307.00
241321	5' Double-Sided Full Wall (Dye Sublimation)	517.00	506.50	496.25	480.75
240912	6' Full Wall (Dye Sublimation)	225.50	221.00	216.50	209.70
240913	6' Double-Sided Full Wall (Dye Sublimation)	475.75	466.25	456.75	442.50
240920	8' Full Wall (Dye Sublimation)	273.25	268.00	262.50	254.25
240921	8' Double-Sided Full Wall (Dye Sublimation)	628.00	615.50	603.00	584.00
240082	10' Full Wall (Unimprinted)	196.10	192.20	188.20	182.40
240083	10' Full Wall (Full-Color Imprint)	329.00	322.25	315.75	306.00
240084	10' Full Wall (Dye Sublimation)	381.25	373.50	366.00	354.50
240184	10' Double-Sided Full Wall (Dye Sublimation)	807.00	790.50	774.50	750.50
241462	10' Full Wall (UV-Printed)	457.50	448.25	439.00	425.25
241463	10' Double-Sided Full Wall (UV-Printed)	968.00	949.00	929.50	900.50
240396	15' Full Wall (Unimprinted)	255.00	249.80	244.70	237.10
240397	15' Full Wall (Full-Color Imprint)	427.50	419.00	410.50	397.75
240398	15' Full Wall (Dye Sublimation)	533.50	523.00	512.00	496.25
240348	15' Double-Sided Full Wall (Dye Sublimation)	1046.00	1025.00	1004.00	973.00
241464	15' Full Wall (UV-Printed)	640.00	627.50	614.50	595.50
241465	15' Double-Sided Full Wall (UV-Printed)	1255.00	1230.00	1205.00	1167.00

**Imprinted wall setup fee: \$20(G)**

**Pricing is subject to change.**

USD MSRP (C)

Description	Product Size	Finished Graphic Size	Product Wt. (Imprint / Full-Bleed / Double-Sided)
5'	57.25"W x 84.5"H	view online template	1.7 lbs. / 2.2 lbs. / 5 lbs.
6'	71.75"W x 84.5"H	view online template	NA / 3 lbs. / 6 lbs.
8'	98.75"W x 84.5"H	view online template	NA / 3.5 lbs. / 7 lbs.
10'	118.25"W x 84.5"H	view online template	3.4 lbs. / 4.4 lbs. / 10 lbs.
15'	176.75"W x 84.5"H	view online template	4.5 lbs. / 5.5 lbs. / 12.5 lbs.



10' full wall with full-color imprint

#### Full Wall Stock Colors

○ White ● Black

15' walls available in white only



10' full wall with UV printing

10' full wall with dye sublimation

**UNIMPRINTED WALL & HARDWARE-ONLY LEAD TIME: SHIPS SAME DAY WHEN ORDERED BEFORE 2 PM CENTRAL**

**PRICES ARE SUBJECT TO CHANGE.** No setup fee on orders placed via our website.

Visit [showdowndisplays.com](http://showdowndisplays.com) for current pricing, graphic templates, product videos and assembly instructions. See pages 288-291 for order details.

SHOWDOWNDISPLAYS.COM · ASI 87188 · PPAI 254687 · SAGE 67383 · PPPC 20101202

IMPRINT DYE SUB UV-PRINTED production lead time after final proof approval  
**4 -OR- 7 -OR- 10 DAYS**



# MARKET UMBRELLAS

1. 8' Square Market Umbrella page 139 2. 7' Steel Market Umbrella with Valance page 132 3. 7' Steel Market Umbrella page 132

## have you considered...

- **size** how large does your umbrella need to be?
- **features** do you need a tilt function or fixed-position umbrella?
- **message** will it need valances for additional brand visibility?
- **weather** will it be used in harsh or windy conditions?
- **accessories** will you need umbrella bases?

## how to **DISPLAY**

Branded market umbrellas provide signage and shade to draw attention from your customers. Perfect for any outdoor environment such as festivals, sporting events, and hospitality/outdoor lounging. Ideal for on-the-go marketing.

# MARKET UMBRELLA COMPARISON CHART

BEST SELLERS ★ SUSTAINABLE ◆	ARC	OPEN DIAMETER SIZE	HEIGHT	CONSTRUCTION			WEIGHT	FEATURES			
				POLE	RIBS	# OF PANELS		VALANCE OPTION	FULL-COLOR IMPRINT	DYE SUBLIMATION	
<b>7' ARC</b>	<b>PG #</b>										
Deluxe ◆	134	86"	82"	94"	38 mm dia. pole from 2 mm aluminum	13 mm dia. fiberglass	6	14 lbs.	✓	✓	
E-Z Glide ◆	136	86"	82"	86"	38 mm aluminum	25 mm aluminum	6	13 lbs.	✓	✓	
Market ◆	133	86"	82"	95"	38 mm dia. aluminum	9 mm fiberglass	6	6 lbs.	✓	✓	
St. Tropez ◆	141	87"	70.5"	95"	38 mm hardwood	25 mm hardwood	6	13 lbs.	valance only	✓	✓
Steel ★ ◆	132	88"	83.5"	96"	38 mm steel	25 mm steel	6	12 lbs.	✓	✓	✓
Venetian ◆	140	88"	83.5"	96"	38 mm powder-coated steel	square 12 mm x 18 mm powder-coated steel	6	10.5 lbs.	valance only	✓	
Wood ★ ◆	137	87"	70.5"	87"	38 mm dia. hardwood	25 mm dia. hardwood	6	13 lbs.	✓	✓	✓
Wood Look Tilting ◆	138	86"	70.5"	94"	38 mm steel	25 mm steel	6	12 lbs.	✓	✓	
<b>8' ARC</b>	<b>PG #</b>										
Square ◆	139	96"	66"	95"	38 mm dia. hardwood	25 mm dia. hardwood	4	10 lbs.		✓	✓
<b>9' ARC</b>	<b>PG #</b>										
Deluxe ◆	135	116"	109"	98"	38 mm dia. pole from 2 mm aluminum	13 mm dia. fiberglass	8	18 lbs.	✓	✓	✓
Wood Look Tilting ◆	139	116"	109"	98"	38 mm steel	25 mm steel	8	13 lbs.		✓	

**4-25 Beaufort Wind Rating:** All market umbrellas have a wind rating of 4. See rating icon underneath the product name. Wind ratings were determined utilizing all available securing/stabilizing options sold with or offered for the product. See page 291 for details.

**1-year Product Warranty:** All market umbrellas are covered by a 1-year warranty.

## Anatomy of a Market Umbrella

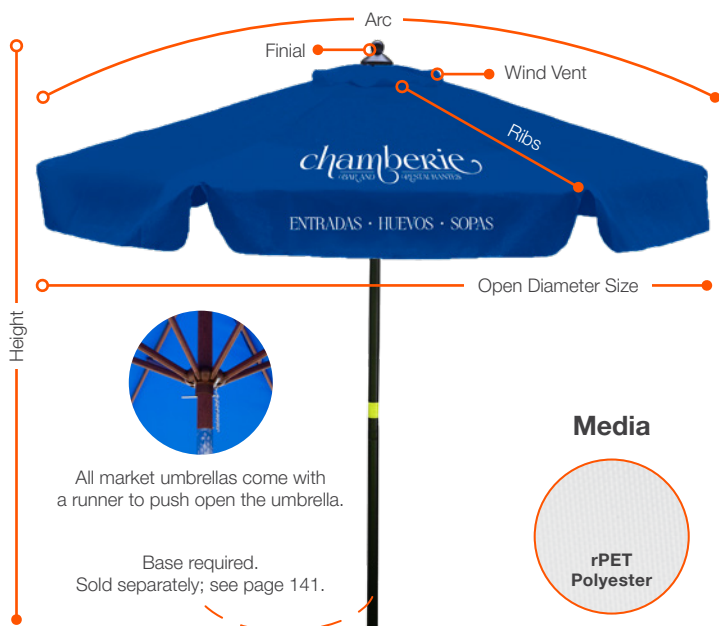

## Media



rPET polyester is made from recycled PET plastic.

## Print Options



## Full-Color Imprint

- Simple to complex graphics
- Vector art required; one imprint per location (panel or valance)
- Available in limited stock fabric colors only
- Min. and max. artwork size requirements apply

## Dye Sublimation

- Simple, complex and photographic graphics
- Vector and raster art accepted
- Artwork is dye sublimated on white fabric only
- Full-color artwork can be printed across the entire umbrella
- No artwork size requirements
- Cannot guarantee graphic alignment across seams

## Choose Your Imprint Locations



One full-color imprint per location. Only one setup fee per market umbrella.

## Solid Stock Market Umbrella Colors

<b>WHITE</b> *	<b>NATURAL</b> PMS 9060	<b>CREAM</b> PMS 7499	<b>CANARY</b> PMS 102	<b>PUMPKIN</b> PMS 166	<b>CRIMSON</b> *
<b>RUBY</b> PMS 201	<b>PINK</b> PMS 204	<b>GRAPE</b> PMS 2607	<b>LIGHT BLUE</b> PMS 543	<b>SKY BLUE</b> PMS 2995	<b>LAPIS</b> *
<b>MIDNIGHT</b> *	<b>LIME GREEN</b> PMS 375	<b>SPRUCE</b> PMS 3435	<b>COOL GRAY</b> PMS COOL GRAY 11	<b>BLACK</b> *	

PMS colors are for reference only and may vary slightly from actual color. See specific products for available stock colors. \* indicates color is available for two-color market umbrellas.



Shown with dye sublimation (single-sided)

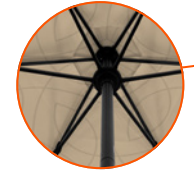

Steel pole and ribs provide a strong frame.



Shown in black/white with full-color imprint (6 locations)



Pole is constructed of steel for an industrial aesthetic.



## 7' STEEL MARKET UMBRELLA



Built to brave the elements, this market umbrella brings lasting comfort to every outdoor moment.

- 88" arc with six-panel construction
- 38 mm steel two-piece pole with 25 mm steel ribs
- Wind vent technology allows greater airflow
- Canopy is constructed of UV-treated rPET polyester
- Available with or without valance; stock color options vary
- Custom options available (call for quote; restrictions may apply)
- Dye sublimation is not eligible for Rush Service

### 7' Steel Market Umbrella

Item #	Description	1	2-5	6-11	12-24
AU0031	Full-Color Imprint Kit (1 Location)	121.00	116.60	112.00	107.60
AU0033	Full-Color Imprint Kit (3 Locations)	130.80	126.00	121.10	116.40
AU0036	Full-Color Imprint Kit (6 Locations)	145.50	140.20	134.70	129.40
AU0385	Dye Sublimation Kit (Single-Sided)	226.60	218.30	209.70	201.60
AU0386	Dye Sublimation Kit (Double-Sided)	296.50	285.75	274.50	263.75

Setup fee: \$20(G)

Pricing is subject to change.

Kit Includes: Hardware and Canopy (Base required. Sold separately; see page 141)

USD MSRP (C)

### 7' Steel Market Umbrella with Valance

Item #	Description	1	2-5	6-11	12-24
AU0V31	Full-Color Imprint Kit (1 Location)	121.00	116.60	112.00	107.60
AU0V32	Full-Color Imprint Kit (2 Locations)	125.90	121.30	116.50	112.00
AU0V33	Full-Color Imprint Kit (3 Locations)	130.80	126.00	121.10	116.40
AU0V36	Full-Color Imprint Kit (6 Locations)	145.50	140.20	134.70	129.40
AUV385	Dye Sublimation Kit (Single-Sided)	226.60	218.30	209.70	201.60
AUV386	Dye Sublimation Kit (Double-Sided)	296.50	285.75	274.50	263.75

Setup fee: \$20(G)

Pricing is subject to change.

Kit Includes: Hardware and Canopy (Base required. Sold separately; see page 141)

USD MSRP (C)

Product Size	Arc	Open Diameter Size	Finished Graphic Size	Product Wt.	Media
83.5"W x 96"H x 83.5"D	88"	83.5"	view online template	12 lbs.	rPET polyester

#### Stock 7' Steel Market Umbrella Colors

- White
- Cream PMS 7499
- Pumpkin PMS 165
- Ruby PMS 201
- Grape PMS 2607
- Sky Blue PMS 2995
- Midnight PMS 2965
- Spruce PMS 3435
- Black
- Natural PMS 9060
- Canary PMS 102
- Crimson PMS 186
- Pink PMS 204
- Light Blue PMS 543
- Lapis PMS 2945
- Lime Green PMS 375
- Cool Gray 11

#### Stock 7' Steel Market Umbrella with Valance Colors

- White
- Lapis PMS 2945
- Spruce PMS 3435
- Black/White
- White/Lapis PMS 2945
- Crimson PMS 186
- Midnight PMS 2965
- Black
- White/Crimson PMS 186
- White/Midnight PMS 2965

PMS colors are for reference only and may vary slightly from actual color.

PRICES ARE SUBJECT TO CHANGE. No setup fee on orders placed via our website.

Visit [showdowndisplays.com](http://showdowndisplays.com) for current pricing, graphic templates, product videos and assembly instructions. See pages 288-291 for order details.

SHOWDOWNDISPLAYS.COM · ASI 87188 · PPAI 254687 · SAGE 67383 · PPPC 20101202

IMPRINT DYE-SUB production lead time after final proof approval  
**7-OR-30 DAYS**



Shown in lime green with 6 locations



Shown in white/crimson with 2 locations



Aluminum pole with fiberglass ribs is ideal for wind resistance.

## 7' MARKET UMBRELLA



Elevate any outdoor space with this tough umbrella!

- 86" arc with six-panel construction
- 38 mm dia. aluminum pole with 9 mm fiberglass ribs
- Two-piece adjustable pole with push-button release for easy setup
- Classic push-button release canopy lock
- Wind vent technology allows greater airflow
- Canopy is constructed of UV-treated rPET polyester featuring triple-reinforced end pockets to prevent tearing and improve durability
- Available with or without valance; stock color options vary
- Custom options available (call for quote; restrictions may apply)

### 7' Market Umbrella

Item #	Description	1	2-5	6-11	12-24
AU0011	Full-Color Imprint Kit (1 Location)	121.10	116.70	112.10	107.70
AU0013	Full-Color Imprint Kit (3 Locations)	130.90	126.10	121.20	116.40
AU0016	Full-Color Imprint Kit (6 Locations)	145.60	140.30	134.80	129.50

**Setup fee: \$20(G)** **Pricing is subject to change.**

Kit Includes: Hardware and Canopy (Base required. Sold separately; see page 141) USD MSRP (C)

### 7' Market Umbrella with Valance

Item #	Description	1	2-5	6-11	12-24
AU0V11	Full-Color Imprint Kit (1 Location)	121.10	116.70	112.10	107.70
AU0V12	Full-Color Imprint Kit (2 Locations)	126.00	121.40	116.60	112.10
AU0V13	Full-Color Imprint Kit (3 Locations)	130.90	126.10	121.20	116.40
AU0V16	Full-Color Imprint Kit (6 Locations)	145.60	140.30	134.80	129.50

**Setup fee: \$20(G)** **Pricing is subject to change.**

Kit Includes: Hardware and Canopy (Base required. Sold separately; see page 141) USD MSRP (C)

**Product Size** 82"W x 95"H x 82"D **Arc** 86" **Open Diameter Size** 82" **Finished Graphic Size** view online template **Product Wt.** 6 lbs. **Media** rPET polyester



Pole is constructed of aluminum for a modern appearance.

#### Stock 7' Market Umbrella Colors

- White
- Cream PMS 7499
- Pumpkin PMS 165
- Ruby PMS 201
- Grape PMS 2607
- Sky Blue PMS 2995
- Midnight PMS 2965
- Spruce PMS 3435
- Black
- Natural PMS 9060
- Canary PMS 102
- Crimson PMS 186
- Pink PMS 204
- Light Blue PMS 543
- Lapis PMS 2945
- Lime Green PMS 375
- Cool Gray 11

#### Stock 7' Market Umbrella with Valance Colors

- White
- Lapis PMS 2945
- Spruce PMS 3435
- Black/White
- White/Lapis PMS 2945
- Crimson PMS 186
- Midnight PMS 2965
- Black
- White/Crimson PMS 186
- White/Midnight PMS 2965

PMS colors are for reference only and may vary slightly from actual color.



Shown in ruby with 3 locations

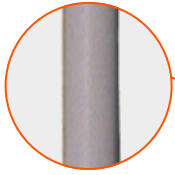

Pole is constructed of anodized aluminum for a high-end appearance.



Shown in lapis with 6 locations

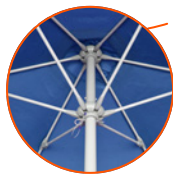

Fiberglass ribs provide strong, wind-resistant support.



## 7' DELUXE MARKET UMBRELLA



Whether for patios, cafes or events enhance your outdoor experience with this durable, modern umbrella!

- 86" arc with six-panel construction
- 38 mm dia. pole is constructed from 2 mm anodized aluminum
- 13 mm dia. fiberglass ribs
- Two-piece adjustable pole for easy setup and storage
- Stainless steel pin locking system secures canopy in place
- Wind vent technology allows greater airflow
- Canopy is constructed of UV-treated rPET polyester featuring triple-reinforced canopy end pockets to prevent tearing and improve durability
- Available with or without valance; stock color options vary
- Custom options available (call for quote; restrictions may apply)

### Stock 7' Deluxe Market Umbrella Colors

- |                     |                      |
|---------------------|----------------------|
| ○ White             | ○ Natural PMS 9060   |
| ○ Cream PMS 7499    | ○ Canary PMS 102     |
| ○ Pumpkin PMS 165   | ○ Crimson PMS 186    |
| ○ Ruby PMS 201      | ○ Pink PMS 204       |
| ○ Grape PMS 2607    | ○ Light Blue PMS 543 |
| ○ Sky Blue PMS 2995 | ○ Lapis PMS 2945     |
| ○ Midnight PMS 2965 | ○ Lime Green PMS 375 |
| ○ Spruce PMS 3435   | ○ Cool Gray 11       |
| ○ Black             |                      |

### Stock 7' Deluxe Market Umbrella with Valance Colors

- |                        |                           |
|------------------------|---------------------------|
| ○ White                | ○ Crimson PMS 186         |
| ○ Lapis PMS 2945       | ○ Midnight PMS 2965       |
| ○ Spruce PMS 3435      | ○ Black                   |
| ○ Black/White          | ○ White/Crimson PMS 186   |
| ○ White/Lapis PMS 2945 | ○ White/Midnight PMS 2965 |

PMS colors are for reference only and may vary slightly from actual color.

### 7' Deluxe Market Umbrella

Item #	Description	1	2-5	6-11	12-24
AU0021	Full-Color Imprint Kit (1 Location)	188.00	181.20	174.00	167.30
AU0023	Full-Color Imprint Kit (3 Locations)	197.80	190.60	183.10	176.00
AU0026	Full-Color Imprint Kit (6 Locations)	212.60	204.80	196.70	189.10

Setup fee: \$20(G)

Pricing is subject to change.

Kit Includes: Hardware and Canopy (Base required. Sold separately; see page 141) USD MSRP (C)

### 7' Deluxe Market Umbrella with Valance

Item #	Description	1	2-5	6-11	12-24
AU0V21	Full-Color Imprint Kit (1 Location)	188.00	181.20	174.00	167.30
AU0V22	Full-Color Imprint Kit (2 Locations)	192.90	185.90	178.60	171.60
AU0V23	Full-Color Imprint Kit (3 Locations)	197.80	190.60	183.10	176.00
AU0V26	Full-Color Imprint Kit (6 Locations)	212.60	204.80	196.70	189.10

Setup fee: \$20(G)

Pricing is subject to change.

Kit Includes: Hardware and Canopy (Base required. Sold separately; see page 141) USD MSRP (C)

Product Size	Arc	Open Diameter Size	Finished Graphic Size	Product Wt.	Media
82"W x 94"H x 82"D	86"	82"	view online template	14 lbs.	rPET polyester

PRICES ARE SUBJECT TO CHANGE. No setup fee on orders placed via our website.

Visit [showdowndisplays.com](http://showdowndisplays.com) for current pricing, graphic templates, product videos and assembly instructions. See pages 288-291 for order details.

SHOWDOWNDISPLAYS.COM · ASI 87188 · PPAI 254687 · SAGE 67383 · PPPC 20101202

production lead time after final proof approval

**7 DAYS**



Shown with dye sublimation (single-sided)



Shown in crimson with full-color imprint (1 location)

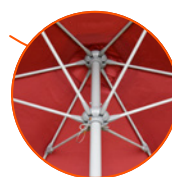

Fiberglass ribs provide strong, wind-resistant support.

## 9' DELUXE MARKET UMBRELLA



From patio to poolside, this market umbrella blends rugged performance with refined design, featuring high-quality construction and a sustainable canopy.

- 116" arc with eight-panel construction
- 38 mm dia. pole is constructed from 2 mm anodized aluminum
- 13 mm dia. fiberglass ribs
- Two-piece adjustable pole with push-button release for easy setup
- Stainless steel pin locking system secures canopy in place
- Wind vent technology allows greater airflow
- Canopy is constructed of rPET polyester featuring triple-reinforced canopy end pockets to prevent tearing and improve durability
- Custom options available (call for quote; restrictions may apply)
- Dye sublimation is not eligible for Rush Service

### 9' Deluxe Market Umbrella

Item #	Description	1	2-5	6-11	12-24
AU0071	Full-Color Imprint Kit (1 Location)	277.50	267.25	256.75	246.80
AU0074	Full-Color Imprint Kit (4 Locations)	292.00	281.50	270.25	259.75
AU0078	Full-Color Imprint Kit (8 Locations)	311.75	300.25	288.50	277.25
AU0389	Dye Sublimation Kit (Single-Sided)	430.25	414.50	398.00	382.50
AU0400	Dye Sublimation Kit (Double-Sided)	500.00	482.00	463.00	445.00

**Setup fee: \$20(G)** **Pricing is subject to change.**  
 Kit Includes: Hardware and Canopy (Base required. Sold separately; see page 141) USD MSRP (C)

### 9' Deluxe Market Umbrella with Valance

Item #	Description	1	2-5	6-11	12-24
AUV389	Dye Sublimation Kit (Single-Sided)	430.25	414.50	398.00	382.50
AUV400	Dye Sublimation Kit (Double-Sided)	500.00	482.00	463.00	445.00

**Setup fee: \$20(G)** **Pricing is subject to change.**  
 Kit Includes: Hardware and Canopy (Base required. Sold separately; see page 141) USD MSRP (C)

Product Size	Arc	Open Diameter Size	Finished Graphic Size	Product Wt.	Media
109"W x 98"H x 109"D	116"	109"	view online template	18 lbs.	rPET polyester

#### Stock 9' Deluxe Market Umbrella Colors

- White
- Cream PMS 7499
- Crimson PMS 186
- Lapis PMS 2945
- Midnight PMS 2965
- Spruce PMS 3435
- Black

*PMS colors are for reference only and may vary slightly from actual color.*



Pole is constructed of anodized aluminum for a high-end appearance.

**PRICES ARE SUBJECT TO CHANGE.** No setup fee on orders placed via our website. Visit [showdowndisplays.com](http://showdowndisplays.com) for current pricing, graphic templates, product videos and assembly instructions. See pages 288-291 for order details. SHOWDOWNDISPLAYS.COM · ASI 87188 · PPAI 254687 · SAGE 67383 · PPPC 20101202

IMPRINT DYE-SUB production lead time after final proof approval  
**7-OR-30 DAYS**



Shown in cool gray 11 with 1 location

Pole is constructed of aluminum for a modern appearance.



Shown in white/crimson with 2 locations

Aluminum pole and ribs provide a sturdy frame.

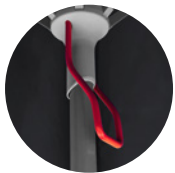

Patented E-Z glide lever for easy opening and closing.

## 7' E-Z GLIDE MARKET UMBRELLA



Shade has never been this simple. Our patented E-Z Glide lever makes setup fast, easy and reliable every time.

- 86" arc with six-panel construction
- 38 mm aluminum pole with 25 mm aluminum ribs
- Two-piece pole design for easy setup and storage
- Wind vent technology allows greater airflow
- Canopy is constructed of UV-treated rPET polyester
- Available with or without valance; stock color options vary
- Custom options available (call for quote; restrictions may apply)

### Stock 7' E-Z Glide Market Umbrella Colors

- |                     |                      |
|---------------------|----------------------|
| ○ White             | ○ Natural PMS 9060   |
| ○ Cream PMS 7499    | ○ Canary PMS 102     |
| ○ Pumpkin PMS 165   | ○ Crimson PMS 186    |
| ○ Ruby PMS 201      | ○ Pink PMS 204       |
| ○ Grape PMS 2607    | ○ Light Blue PMS 543 |
| ○ Sky Blue PMS 2995 | ○ Lapis PMS 2945     |
| ○ Midnight PMS 2965 | ○ Lime Green PMS 375 |
| ○ Spruce PMS 3435   | ○ Cool Gray 11       |
| ○ Black             |                      |

### Stock 7' E-Z Glide Market Umbrella with Valance Colors

- |                        |                           |
|------------------------|---------------------------|
| ○ White                | ○ Crimson PMS 186         |
| ○ Lapis PMS 2945       | ○ Midnight PMS 2965       |
| ○ Spruce PMS 3435      | ○ Black                   |
| ○ Black/White          | ○ White/Crimson PMS 186   |
| ○ White/Lapis PMS 2945 | ○ White/Midnight PMS 2965 |

PMS colors are for reference only and may vary slightly from actual color.

### 7' E-Z Glide Market Umbrella

Item #	Description	1	2-5	6-11	12-24
AU0001	Full-Color Imprint Kit (1 Location)	141.20	136.00	130.60	125.60
AU0003	Full-Color Imprint Kit (3 Locations)	151.00	145.50	139.70	134.30
AU0006	Full-Color Imprint Kit (6 Locations)	165.70	159.60	153.30	147.40

Setup fee: \$20(G)

Pricing is subject to change.

Kit Includes: Hardware and Canopy (Base required. Sold separately; see page 141)

USD MSRP (C)

### 7' E-Z Glide Market Umbrella with Valance

Item #	Description	1	2-5	6-11	12-24
AU00V1	Full-Color Imprint Kit (1 Location)	141.20	136.00	130.60	125.60
AU00V2	Full-Color Imprint Kit (2 Locations)	146.10	140.70	135.20	129.90
AU00V3	Full-Color Imprint Kit (3 Locations)	151.00	145.50	139.70	134.30
AU00V6	Full-Color Imprint Kit (6 Locations)	165.70	159.60	153.30	147.40

Setup fee: \$20(G)

Pricing is subject to change.

Kit Includes: Hardware and Canopy (Base required. Sold separately; see page 141)

USD MSRP (C)

Product Size	Arc	Open Diameter Size	Finished Graphic Size	Product Wt.	Media
82"W x 94"H x 82"D	86"	82"	view online template	13 lbs.	rPET polyester

production lead time after final proof approval  
**7 DAYS**



Shown in white/midnight with full-color imprint (2 locations)

Pole is constructed of hardwood for a natural aesthetic.

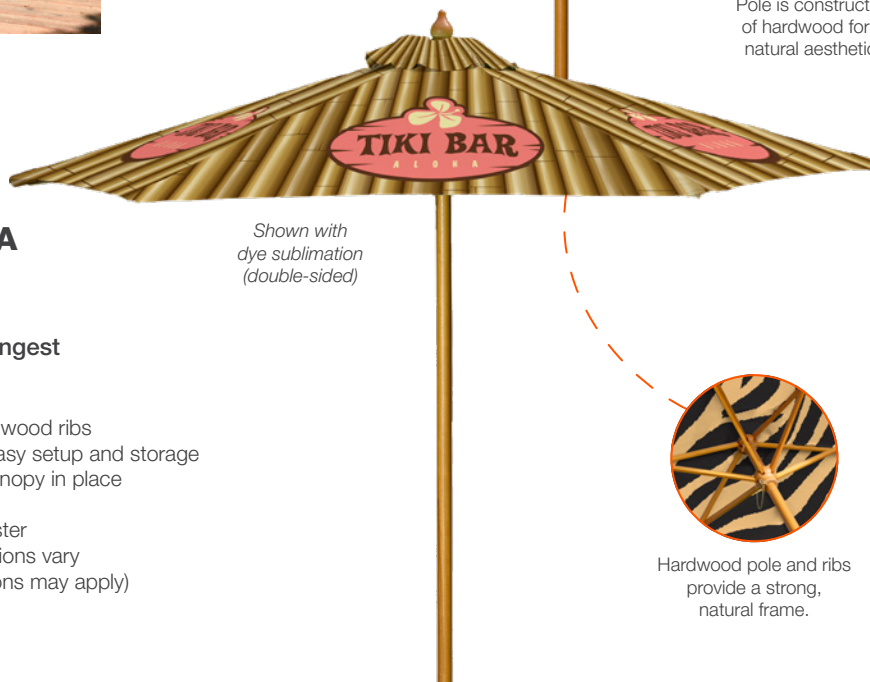

Shown with dye sublimation (double-sided)

Hardwood pole and ribs provide a strong, natural frame.

## 7' WOOD MARKET UMBRELLA



Forged by nature, built to last with the strongest wood frame in the industry!

- 87" arc with six-panel construction
- 38 mm dia. hardwood pole with 25 mm dia. hardwood ribs
- Two-piece brass screw-locking pole design for easy setup and storage
- Manual pin-and-chain locking system secures canopy in place
- Wind vent technology allows greater airflow
- Canopy is constructed of UV-treated rPET polyester
- Available with or without valance; stock color options vary
- Custom options available (call for quote; restrictions may apply)
- Dye sublimation is not eligible for Rush Service

### 7' Wood Market Umbrella

Item #	Description	1	2-5	6-11	12-24
AU0041	Full-Color Imprint Kit (1 Location)	132.90	128.00	123.00	118.20
AU0043	Full-Color Imprint Kit (3 Locations)	142.70	137.50	132.10	126.90
AU0046	Full-Color Imprint Kit (6 Locations)	157.40	151.70	145.70	140.00
AU0401	Dye Sublimation Kit (Single-Sided)	238.50	229.80	220.70	212.10
AU0402	Dye Sublimation Kit (Double-Sided)	308.50	297.25	285.50	274.50

Setup fee: \$20(G)

Pricing is subject to change.

Kit Includes: Hardware and Canopy (Base required. Sold separately; see page 141)

USD MSRP (C)

### 7' Wood Market Umbrella with Valance

Item #	Description	1	2-5	6-11	12-24
AU0V41	Full-Color Imprint Kit (1 Location)	132.90	128.00	123.00	118.20
AU0V42	Full-Color Imprint Kit (2 Locations)	137.80	132.80	127.50	122.60
AU0V43	Full-Color Imprint Kit (3 Locations)	142.70	137.50	132.10	126.90
AU0V46	Full-Color Imprint Kit (6 Locations)	157.40	151.70	145.70	140.00
AUV401	Dye Sublimation Kit (Single-Sided)	238.50	229.80	220.70	212.10
AUV402	Dye Sublimation Kit (Double-Sided)	308.50	297.25	285.50	274.50

Setup fee: \$20(G)

Pricing is subject to change.

Kit Includes: Hardware and Canopy (Base required. Sold separately; see page 141)

USD MSRP (C)

Product Size 70.5"W x 95"H x 70.5"D Arc 87" Open Diameter Size 70.5" Finished Graphic Size view online template Product Wt. 13 lbs. Media rPET polyester

#### Stock 7' Wood Market Umbrella Colors

- White
- Cream PMS 7499
- Pumpkin PMS 165
- Ruby PMS 201
- Grape PMS 2607
- Sky Blue PMS 2995
- Midnight PMS 2965
- Spruce PMS 3435
- Black
- Natural PMS 9060
- Canary PMS 102
- Crimson PMS 186
- Pink PMS 204
- Light Blue PMS 543
- Lapis PMS 2945
- Lime Green PMS 375
- Cool Gray 11

#### Stock 7' Wood Market Umbrella with Valance Colors

- White
- Lapis PMS 2945
- Spruce PMS 3435
- Black/White
- White/Lapis PMS 2945
- Crimson PMS 186
- Midnight PMS 2965
- Black
- White/Crimson PMS 186
- White/Midnight PMS 2965

PMS colors are for reference only and may vary slightly from actual color.

PRICES ARE SUBJECT TO CHANGE. No setup fee on orders placed via our website. Visit [showdowndisplays.com](http://showdowndisplays.com) for current pricing, graphic templates, product videos and assembly instructions. See pages 288-291 for order details. SHOWDOWNDISPLAYS.COM · ASI 87188 · PPAI 254687 · SAGE 67383 · PPPC 20101202

IMPRINT DYE-SUB production lead time after final proof approval  
**7 -OR- 30 DAYS**



Shown in crimson with 3 locations



Easily tilt your pole to stay in the shade.



Shown in lapis with 1 location



Pole is constructed of steel with faux wood finish for a classic appearance.



## 7' WOOD LOOK TILTING MARKET UMBRELLA



Effortlessly adjust this ultra-strong umbrella to block the sun from any angle.

- 86" arc with six-panel construction
- 38 mm steel two-piece pole with 25 mm steel ribs and faux wood finish
- Features three position zinc tilt hardware
- Wind vent technology allows greater airflow
- Canopy is constructed of UV-treated rPET polyester
- Available with or without valance; stock color options vary
- Custom options available (call for quote; restrictions may apply)

### Stock 7' Wood Look Tilting Market Umbrella Colors

- White
- Natural PMS 9060
- Cream PMS 7499
- Canary PMS 102
- Pumpkin PMS 165
- Crimson PMS 186
- Ruby PMS 201
- Pink PMS 204
- Grape PMS 2607
- Light Blue PMS 543
- Sky Blue PMS 2995
- Lapis PMS 2945
- Midnight PMS 2965
- Lime Green PMS 375
- Spruce PMS 3435
- Cool Gray 11
- Black

### Stock 7' Wood Look Tilting Market Umbrella with Valance Colors

- White
- Crimson PMS 186
- Lapis PMS 2945
- Midnight PMS 2965
- Spruce PMS 3435
- Black
- Black/White
- White/Crimson PMS 186
- White/Lapis PMS 2945
- White/Midnight PMS 2965

PMS colors are for reference only and may vary slightly from actual color.

### 7' Wood Look Tilting Market Umbrella

Item #	Description	1	2-5	6-11	12-24
AU0051	Full-Color Imprint Kit (1 Location)	130.80	126.00	121.10	116.40
AU0053	Full-Color Imprint Kit (3 Locations)	140.60	135.50	130.10	125.10
AU0056	Full-Color Imprint Kit (6 Locations)	155.30	149.70	143.80	138.20

Setup fee: \$20(G)

Pricing is subject to change.

Kit Includes: Hardware and Canopy (Base required. Sold separately; see page 141)

USD MSRP (C)

### 7' Wood Look Tilting Market Umbrella with Valance

Item #	Description	1	2-5	6-11	12-24
AU0V51	Full-Color Imprint Kit (1 Location)	130.80	126.00	121.10	116.40
AU0V52	Full-Color Imprint Kit (2 Locations)	135.70	130.80	125.60	120.70
AU0V53	Full-Color Imprint Kit (3 Locations)	140.60	135.50	130.10	125.10
AU0V56	Full-Color Imprint Kit (6 Locations)	155.30	149.70	143.80	138.20

Setup fee: \$20(G)

Pricing is subject to change.

Kit Includes: Hardware and Canopy (Base required. Sold separately; see page 141)

USD MSRP (C)

Product Size	Arc	Open Diameter Size	Finished Graphic Size	Product Wt.	Media
70.5"W x 94"H x 70.5"D	86"	70.5"	view online template	12 lbs.	rPET polyester

production lead time after final proof approval  
**7 DAYS**

## 9' WOOD LOOK TILTING MARKET UMBRELLA



Stay covered by simply tilting and turning this durable umbrella to follow the sun and stay in control.

- 116" arc with eight-panel construction
- 38 mm steel two-piece pole with 25 mm steel ribs and faux wood finish
- Features three position zinc tilt hardware
- Wind vent technology allows greater airflow
- Canopy is constructed of UV-treated rPET polyester
- Custom options available (call for quote; restrictions may apply)



### 9' Wood Look Tilting Market Umbrella

Item #	Description	1	2-5	6-11	12-24
AU0091	Full-Color Imprint Kit (1 Location)	216.70	208.80	200.60	192.80
AU0094	Full-Color Imprint Kit (4 Locations)	231.40	223.00	214.20	205.80
AU0098	Full-Color Imprint Kit (8 Locations)	251.00	241.90	232.30	223.30

**Setup fee: \$20(G)** **Pricing is subject to change.**  
 Kit Includes: Hardware and Canopy (Base required. Sold separately; see page 141) USD MSRP (C)

Product Size	Arc	Open Diameter Size	Finished Graphic Size	Product Wt.	Media
109"W x 98"H x 109"D	116"	109"	view online template	13 lbs.	rPET polyester

#### Stock 9' Wood Look Tilting Market Umbrella Colors

- White
- Cream PMS 7499
- Crimson PMS 186
- Lapis PMS 2945
- Midnight PMS 2965
- Spruce PMS 3435
- Black

*PMS colors are for reference only and may vary slightly from actual color.*



Steel pole and ribs provide a strong frame.



Pole is constructed of steel with faux wood finish for a classic appearance.

## 8' SQUARE MARKET UMBRELLA



With a bold square canopy, this durable wood umbrella blends eco-friendly design with a sleek, modern aesthetic.

- 96" arc with four-panel construction
- 38 mm dia. hardwood pole with 25 mm dia. hardwood ribs
- Two-piece brass screw-locking pole design for easy setup and storage
- Manual pin-and-chain locking system secures canopy in place
- Wind vent technology allows greater airflow
- Canopy is constructed of UV-treated rPET polyester
- Custom options available (call for quote; restrictions may apply)
- Dye sublimation is not eligible for Rush Service



Shown with dye sublimation (single-sided)

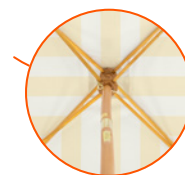

Hardwood pole and ribs provide a strong, natural frame.

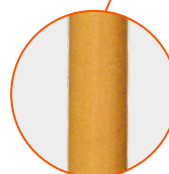

Pole is constructed of hardwood for a natural aesthetic.

### 8' Square Market Umbrella

Item #	Description	1	2-5	6-11	12-24
AU0061	Full-Color Imprint Kit (1 Location)	142.30	137.10	131.70	126.50
AU0062	Full-Color Imprint Kit (2 Locations)	147.20	141.80	136.20	130.90
AU0064	Full-Color Imprint Kit (4 Locations)	157.00	151.20	145.30	139.60
AU0387	Dye Sublimation Kit (Single-Sided)	267.75	258.00	247.90	238.20
AU0388	Dye Sublimation Kit (Double-Sided)	337.75	325.50	312.75	300.50

**Setup fee: \$20(G)** **Pricing is subject to change.**  
 Kit Includes: Hardware and Canopy (Base required. Sold separately; see page 141) USD MSRP (C)

Product Size	Arc	Open Diameter Size	Finished Graphic Size	Product Wt.	Media
66"W x 95"H x 66"D	96"	66"	view online template	10 lbs.	rPET polyester

#### Stock 8' Square Market Umbrella Colors

- Crimson PMS 186
- Midnight PMS 2965
- Spruce PMS 3435
- Black

*PMS colors are for reference only and may vary slightly from actual color.*

**PRICES ARE SUBJECT TO CHANGE.** No setup fee on orders placed via our website. Visit [showdowndisplays.com](http://showdowndisplays.com) for current pricing, graphic templates, product videos and assembly instructions. See pages 288-291 for order details. SHOWDOWNDISPLAYS.COM · ASI 87188 · PPAI 254687 · SAGE 67383 · PPPC 20101202

IMPRINT DYE-SUB production lead time after final proof approval  
**7-OR-30 DAYS**

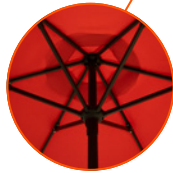

Steel pole and double-rib frame for stability.

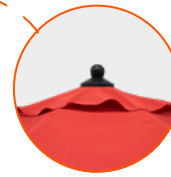

Wind vent technology allows greater airflow.



L-shaped ribs extend into valance to keep the canopy taut.



Pole is constructed of powder-coated steel for a sleek, consistent finish.

Shown in black with 6 locations

## VENETIAN MARKET UMBRELLA



This beautiful market umbrella will transform your outdoor area into a sophisticated branded event.

- 88" arc with six-panel construction
- 38 mm powder-coated steel pole with a square 12 mm x 18 mm double-rib frame
- Two-piece pole with push-button release for easy setup
- Features a steep canopy for better visibility
- Canopy is bolted into double-rib frame
- Canopy is constructed of UV-treated rPET polyester
- Custom options available (call for quote; restrictions may apply)

### Venetian Market Umbrella

Item #	Description	1	2-5	6-11	12-24
AU02V1	Full-Color Imprint Kit (1 Location)	176.80	170.30	163.60	157.30
AU02V2	Full-Color Imprint Kit (2 Locations)	181.70	175.10	168.20	161.60
AU02V3	Full-Color Imprint Kit (3 Locations)	186.60	179.80	172.70	166.00
AU02V6	Full-Color Imprint Kit (6 Locations)	201.30	194.00	186.30	179.10

Setup fee: \$20(G)

Pricing is subject to change.

Kit Includes: Hardware and Canopy (Base required. Sold separately; see page 141)

USD MSRP (C)

Product Size	Arc	Open Diameter	Size	Finished Graphic Size	Product Wt.	Media
83.5"W x 96"H x 83.5"D	88"	83.5"		view online template	10.5 lbs.	rPET polyester



Push-button release allows for easy setup and teardown.



When closed, use attached ties to keep canopy securely together.

#### Stock Venetian Market Umbrella Colors

- Crimson PMS 186
- Black
- Midnight PMS 2965

PMS colors are for reference only and may vary slightly from actual color.



production lead time after final proof approval

**7 DAYS**

**PRICES ARE SUBJECT TO CHANGE.** No setup fee on orders placed via our website. Visit [showdowndisplays.com](http://showdowndisplays.com) for current pricing, graphic templates, product videos and assembly instructions. See pages 288-291 for order details.

SHOWDOWNDISPLAYS.COM · ASI 87188 · PPAI 254687 · SAGE 67383 · PPPC 20101202

## ST. TROPEZ MARKET UMBRELLA



Bring charm to any outdoor event with this fringed market umbrella.

- 87" arc with six-panel construction
- 38 mm hardwood pole with 25 mm hardwood ribs
- Features fringe border on valance
- Canopy is constructed of UV-treated rPET polyester
- Two-piece pole for easy setup and storage
- Manual brass pin-and-chain locking system secures canopy in place
- Custom options available (call for quote; restrictions may apply)
- Dye sublimation is not eligible for Rush Service



Shown with dye sublimation (double-sided)



Shown in midnight with full-color imprint (1 location)

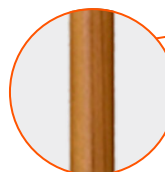

Pole is constructed of hardwood for a natural aesthetic.

### St. Tropez Market Umbrella

Item #	Description	1	2-5	6-11	12-24
AU01V1	Full-Color Imprint Kit (1 Location)	158.30	152.50	146.50	140.80
AU01V2	Full-Color Imprint Kit (2 Locations)	163.20	157.20	151.00	145.10
AU01V3	Full-Color Imprint Kit (3 Locations)	168.10	161.90	155.60	149.50
AU01V6	Full-Color Imprint Kit (6 Locations)	182.80	176.10	169.20	162.60
AUV387	Dye Sublimation Kit (Single-Sided)	277.50	267.25	256.75	246.80
AUV388	Dye Sublimation Kit (Double-Sided)	347.50	334.75	321.50	309.00

Setup fee: \$20(G)

Pricing is subject to change.

Kit Includes: Hardware and Canopy (Base required. Sold separately; see page 141)

USD MSRP (C)

Product Size	Arc	Open Diameter Size	Finished Graphic Size	Product Wt.	Media
70.5"W x 95"H x 70.5"D	87"	70.5"	view online template	13 lbs.	rPET polyester



Increase the reach of your brand with double-sided dye sublimation.



Natural colored fringe brings festive character to your space.

### Stock St. Tropez Market Umbrella Colors

- White
- Midnight PMS 2965
- Black

PMS colors are for reference only and may vary slightly from actual color.

## MARKET UMBRELLA BASES



### Market Umbrella Bases

Item #	Description	Product Wt.	1	2-5	6-11	12-24
AUB000	Rounded Square	3 lbs.	43.82	42.22	40.56	38.98
AUB001	Round	33 lbs.	84.70	81.60	78.40	75.35

Pricing is subject to change.

USD MSRP (C)



### Round Market Umbrella Base

- Compatible with our market umbrellas; table required (not included)
- Matte black finish
- Weather-resistant
- Constructed with solid resin



### Rounded Square Market Umbrella Base

- Compatible with our market umbrellas; table required (not included)
- Weather-resistant
- Constructed with hard plastic
- Can be filled with water or sand for added stability
- Weighs up to 36 lbs. when filled with 4 gallons of water

Base Colors  Black  White

HARDWARE-ONLY LEAD TIME: SHIPS SAME DAY WHEN ORDERED BEFORE 2 PM CENTRAL

PRICES ARE SUBJECT TO CHANGE. No setup fee on orders placed via our website.

Visit [showdowndisplays.com](http://showdowndisplays.com) for current pricing, graphic templates, product videos and assembly instructions. See pages 288-291 for order details.

SHOWDOWNDISPLAYS.COM · ASI 87188 · PPAI 254687 · SAGE 67383 · PPPC 20101202

IMPRINT DYE-SUB production lead time after final proof approval  
**7-OR-30 DAYS**



# HANDHELD UMBRELLAS

1. Redwood page 158 2. Steal page 145 3. Freedom page 158 4. CEO page 160 5. Rebel 2 page 159 6. Park Avenue 1 page 152

## have you considered...

- **transport** do you need a folding or stick umbrella?
- **size** how large does your umbrella need to be?
- **message** do you want a full-color imprint or full-bleed dye sublimation umbrella?
- **weather** will it be used in harsh or windy conditions?
- **use** are you looking for auto-open/close features?

## how to **FEATURE**

Handheld umbrellas offer practical function and mobile branding. Ideal for street teams, event giveaways or any branded outdoor event. Great for year-round events as umbrellas are used in rain or shine. Brand with your logo or full-bleed design.

# STICK HANDHELD UMBRELLA COMPARISON CHART

BEST SELLERS ★ SUSTAINABLE ◆	GOOD	PG #	ARC	CONSTRUCTION			FEATURES				DYE SUBLIMATION
				SHAFT	RIBS	HANDLE	VENTED	MANUAL / AUTOMATIC	SAFETY GLIDE	INVERTED	
Challenger II ◆	◆	147	62"	fiberglass	fiberglass double-rib	anti-slip rubber with medallion	✓	manual	✓		
Challenger w/ Alternating Panels ◆	◆	148	62"	fiberglass	fiberglass double-rib	anti-slip rubber with medallion	✓	manual	✓		
Challenger w/ Checkerboard Panels ◆	◆	148	62"	fiberglass	fiberglass double-rib	anti-slip rubber with medallion	✓	manual	✓		
Classic Fashion ◆	◆	155	48"	steel	fiberglass	curved black hardwood		manual			
Gale Force Golf ◆	◆	162	64"	fiberglass	fiberglass double-rib	anti-slip, color-matched, rubber	✓	manual	✓		
Golf ◆	◆	147	62"	black fiberglass	black fiberglass	anti-slip rubber		manual			✓ (only)
Square Challenger ◆	◆	150	68"	fiberglass	fiberglass double-rib	anti-slip rubber with medallion	✓	manual	✓		
Storm 2 ◆	◆	163	60"	fiberglass	fiberglass	blonde hardwood		manual	✓		
BETTER		PG #		SHAFT	RIBS	HANDLE	VENTED	MANUAL / AUTOMATIC	SAFETY GLIDE	INVERTED	DYE SUBLIMATION
Euro Fashion ◆	◆	155	48"	wood	fiberglass	curved wooden		auto-open			
Luxe ◆	◆	154	48"	dark mahogany	fiberglass	curved wooden		auto-open			
Redwood ◆	◆	158	46"	steel	fiberglass	wood		auto-open			
Sport & Street ◆	◆	151	48"	black steel	black steel	hardwood		auto-open			
BEST		PG #		SHAFT	RIBS	HANDLE	VENTED	MANUAL / AUTOMATIC	SAFETY GLIDE	INVERTED	DYE SUBLIMATION
Auto Challenger ◆	◆	149	62"	fiberglass	fiberglass double-rib	anti-slip rubber with medallion	✓	auto-open	✓		
Hurricane ◆	◆	156	60"	fiberglass	fiberglass	rubber	✓	auto-open			
Park Avenue 4 ◆	◆	153	46"	steel with ABS plastic	fiberglass	cherry wood		auto-open		✓	
Rebel 2 ★ ◆	◆	159	46"	fiberglass	fiberglass	rubber grip		auto-open		✓	✓
SPECIALTY		PG #		SHAFT	RIBS	HANDLE	VENTED	MANUAL / AUTOMATIC	SAFETY GLIDE	INVERTED	DYE SUBLIMATION
JingleBrella™ ◆	◆	157	50"	black steel	fiberglass	matte black rubber		auto-open			
Spotlight ◆	◆	157	50"	black steel	black fiberglass	matte black ABS rubber		auto-open			

## Anatomy of a Handheld Umbrella

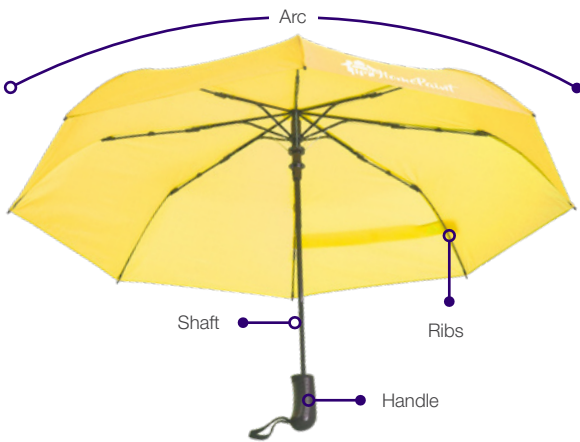

## Print Options



### Full-Color Imprint

- Simple to complex graphics
- Vector art required; one imprint per location
- Available in limited stock fabric colors only
- Min. and max. artwork size requirements apply

### Dye Sublimation

- Simple, complex and photographic graphics
- Vector and raster art accepted
- Art is dye sublimated on white fabric only
- Full-color artwork can be printed across the entire umbrella
- No artwork size requirements

## Choose Your Imprint Locations



One imprint per location.  
Only one setup fee per handheld umbrella.

## Solid Stock Handheld Umbrella Colors

WHITE *	CANARY PMS 102	PUMPKIN *	CRIMSON *	RUBY *	PINK PMS 204
PURPLE *	CYAN PMS 2925	AZURE *	INDIGO *	LIME GREEN *	SPRUCE *
GRAY PMS 423	COOL GRAY * PMS COOL GRAY 11	BLACK *			

PMS colors are for reference only and may vary slightly from actual color. See specific products for available stock colors.  
\* indicates color is available for two-color handheld umbrellas.

# FOLDING HANDHELD UMBRELLA COMPARISON CHART

BEST SELLERS ★ SUSTAINABLE ◆	GOOD	PG #	ARC	CONSTRUCTION			FEATURES				
				SHAFT	RIBS	HANDLE	VENTED	MANUAL / AUTOMATIC	SAFETY GLIDE	INVERTED	DYE SUBLIMATION
Park Avenue 1	◆	152	44"	hexagon steel	fiberglass	cherry wood	windproof	auto-open			
Steal ★ ◆	◆	145	44"	steel	fiberglass	anti-slip rubber		auto-open			✓
BETTER		PG #		SHAFT	RIBS	HANDLE	VENTED	MANUAL / AUTOMATIC	SAFETY GLIDE	INVERTED	DYE SUBLIMATION
CEO	◆	160	46"	aluminum	fiberglass	curved, faux wooden		auto-open/close			
Champ II	◆	151	58"	steel	fiberglass	anti-slip rubber	✓	auto-open			
E-Z Fold	◆	146	42"	steel	fiberglass	rubber coated plastic		auto-open/close			
Folding Challenger III	◆	150	48"	steel	fiberglass	anti-slip, rubber coated plastic	✓	auto-open			
Madison	◆	161	46"	aluminum	fiberglass	rubber		auto-open/close			
Park Avenue 2	◆	152	46"	steel	fiberglass	cherry wood	✓	auto-open			
Park Avenue 3	◆	153	58"	black steel	fiberglass	cherry wood	✓	auto-open			
Sport Challenger	◆	149	46"	fiberglass	fiberglass	rubber	✓	auto-open			
Super Pocket Mini	◆	163	43"	aluminum	aluminum	rubber		auto-open/close			
Super Windy	◆	162	46"	hexagon steel	fiberglass	wood with nickle accents	✓	auto-open			
Zion	◆	156	44"	black steel	black fiberglass	cherry wood		auto-open			
BEST		PG #		SHAFT	RIBS	HANDLE	VENTED	MANUAL / AUTOMATIC	SAFETY GLIDE	INVERTED	DYE SUBLIMATION
Duke	◆	161	44"	steel	fiberglass	black and gun-metal rubber	windproof	auto-open/close			
E-Z Fold Vented	◆	146	46"	steel	fiberglass	rubber coated plastic	✓	auto-open/close			
Freedom	◆	158	46"	steel	steel	rubber coated plastic	✓	auto-open/close			
Judge	◆	160	54"	nickel-plated steel	fiberglass	hard plastic and faux wood grain	✓	auto-open/close	✓		
Park Avenue 5	◆	154	46"	chromed steel	fiberglass	cherry wood		auto-open/close		✓	
Rebel 3	◆	159	46"	fiberglass	fiberglass	rubber grip		auto-open/close		✓	
Super Flat Mini ★ ◆	◆	163	43"	aluminum	fiberglass	rubber	✓	auto-open/close			

## Media



rPET polyester is made from recycled PET plastic.



A lightweight, durable and water-repellent material.



## PFAS-Free Commitment

All handheld umbrellas are PFAS-free! Known as forever chemicals, PFAS are harmful to both the environment and human health. By eliminating PFAS from all our handheld umbrellas, we are taking a big step towards reducing our environmental impact.

## RAINALERTZ™ APP

Handheld umbrellas are powered by our patented RainAlertz™ app.



Download in your app store.

Available for all major operating systems.

### Get Started in 4 Easy Steps



**Step 1.** Download the free RainAlertz™ app on your phone.

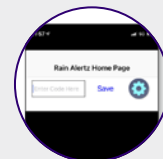

**Step 2.** Enter your program code.



**Step 3.** RainAlertz™ provides a branded micro-site with your customer's logo.



**Step 4.** Receive a branded push-notification when there's at least a 60% chance of rain.



Shown with dye sublimation (double-sided)

Single-sided dye sublimated umbrellas are printed on one side; reverse image shows through underneath.

## STEAL UMBRELLA



This versatile and eco-friendly umbrella is the perfect everyday companion, offering great quality at a low price.

- 44" arc with eight-panel construction
- Auto-open folding umbrella
- Steel shaft and fiberglass ribs
- Anti-slip rubber handle with wrist strap
- Solid-color canopy is constructed of rPET polyester;
- two-color canopy is constructed of rPET polyester and nylon
- Minimum order quantity of 12 for full-color imprint;
- 25 for dye sublimation
- Custom options available (call for quote; restrictions may apply)
- Dye sublimation is not eligible for Rush Service



Shown in white/pumpkin with full-color imprint (1 location)

Auto-open button is easily accessible on the anti-slip rubber handle with wrist strap.

### Full-Color Imprint

Item #	Description	12-24	25-49	50-74	75-99
A00041	Steal Umbrella (1 Location)	12.54	12.06	11.55	11.03
A00042	Steal Umbrella (2 Locations)	13.90	13.36	12.80	12.23
A00044	Steal Umbrella (4 Locations)	16.62	16.12	15.62	15.29

Setup fee: \$20(G)

Stock fabric colors with full-color artwork. Minimum order quantity of 12.

Pricing is subject to change.

USD MSRP (C)

Closed Product Size	Arc	Finished Graphic Size	Product Wt.	Media
1.5"W x 13"H x 1.5"D	44"	view online template	11 lbs. (qty 12)	solid-color: rPET polyester two-color: rPET polyester (white) / nylon (color)

### Dye Sublimation

Item #	Description	25-49	50-99	100-249	250-499
A00380	Steal Umbrella (Single-Sided)	43.60	41.92	40.16	38.35
A00381	Steal Umbrella (Double-Sided)	51.55	49.57	47.49	45.35

Setup fee: \$20(G)

White fabric fully dye sublimated with full-color artwork. Minimum order quantity of 25.

Pricing is subject to change.

USD MSRP (C)

Closed Product Size	Arc	Finished Graphic Size	Product Wt.	Media
1.5"W x 13"H x 1.5"D	44"	view online template	23 lbs. (qty 25)	rPET polyester

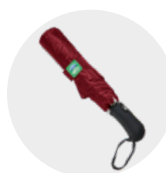

Folds down to 13" for portability.

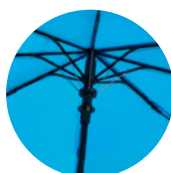

Steel shaft with fiberglass ribs for lightweight durability.

### Stock Steal Umbrella Colors

○ White	● Canary PMS 102
● Pumpkin PMS 165	● Crimson PMS 186
● Ruby PMS 201	● Pink PMS 204
● Purple PMS 2685	● Cyan PMS 2925
● Azure PMS 286	● Indigo PMS 295
● Lime Green PMS 375	● Spruce PMS 3435
● Cool Gray 11	● Black
● Black/White	● White/Pumpkin PMS 165
● White/Crimson PMS 186	● White/Ruby PMS 201
● White/Purple PMS 2685	● White/Azure PMS 286
● White/Indigo PMS 295	● White/Spruce PMS 3435

PMS colors are for reference only and may vary slightly from actual color.

**PRICES ARE SUBJECT TO CHANGE.** No setup fee on orders placed via our website. Visit [showdowndisplays.com](http://showdowndisplays.com) for current pricing, graphic templates, product videos and assembly instructions. See pages 288-291 for order details. SHOWDOWNDISPLAYS.COM · ASI 87188 · PPAI 254687 · SAGE 67383 · PPPC 20101202

IMPRINT DYE-SUB production lead time after final proof approval  
**5-OR-30 DAYS**



Shown in indigo with 4 locations

**Stock E-Z Fold Umbrella Colors**

- Indigo PMS 295
- Gray PMS 423
- Black

*PMS colors are for reference only and may vary slightly from actual color.*



Umbrella folds down to 11" for portability.

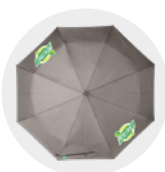

Canopy features a specially designed film that allows the umbrella to maintain its shape.



Auto-open/close button is easily accessible on a rubber coated plastic handle.

**E-Z FOLD UMBRELLA**



The umbrella that folds itself! A smart, sleek and innovative solution!

- 42" arc with eight-panel construction
- Auto-open/close folding umbrella
- Steel shaft and fiberglass ribs
- Rubber coated plastic handle with wrist strap
- Canopy constructed with rPET polyester
- Minimum order quantity of 12
- Custom options available (call for quote; restrictions may apply)

**Full-Color Imprint**

Item #	Description	12-24	25-49	50-74	75-99
A00081	E-Z Fold Umbrella (1 Location)	34.34	33.02	31.63	30.20
A00082	E-Z Fold Umbrella (2 Locations)	35.70	34.63	33.56	32.84
A00084	E-Z Fold Umbrella (4 Locations)	38.42	37.27	36.11	35.35

**Setup fee: \$20(G)**

**Pricing is subject to change.**

Stock fabric colors with full-color artwork. Minimum order quantity of 12.

USD MSRP (C)

Closed Product Size	Arc	Finished Graphic Size	Product Wt.	Media
1.5"W x 11"H x 1.5"D	42"	view online template	12 lbs. (qty 12)	rPET polyester

**E-Z FOLD VENTED UMBRELLA**



A vented umbrella that automatically folds itself provides a smart and innovative solution for all-weather protection!

- 46" arc with eight-panel construction
- Auto-open/close folding umbrella
- Steel shaft and fiberglass ribs
- Rubber coated plastic handle with wrist strap
- Canopy constructed with rPET polyester
- Minimum order quantity of 12
- Custom options available (call for quote; restrictions may apply)

**Full-Color Imprint**

Item #	Description	12-24	25-49	50-74	75-99
A00331	E-Z Fold Vented Umbrella (1 Location)	36.52	35.42	34.33	33.60
A00332	E-Z Fold Vented Umbrella (2 Locations)	37.88	36.74	35.61	34.85
A00334	E-Z Fold Vented Umbrella (4 Locations)	40.60	39.38	38.16	37.35

**Setup fee: \$20(G)**

**Pricing is subject to change.**

Black with full-color artwork. Minimum order quantity of 12.

USD MSRP (C)

Closed Product Size	Arc	Finished Graphic Size	Product Wt.	Media
1.5"W x 11"H x 1.5"D	46"	view online template	11.25 lbs. (qty 12)	rPET polyester



Shown with 2 locations



Wind vent technology allows greater airflow.



Umbrella folds down to 11" for portability.



Canopy features a specially designed film that allows the umbrella to maintain its shape.



Auto-open/close button is easily accessible on a rubber coated plastic handle.

production lead time after final proof approval

**5 DAYS**

**PRICES ARE SUBJECT TO CHANGE.** No setup fee on orders placed via our website.

Visit [showdowndisplays.com](http://showdowndisplays.com) for current pricing, graphic templates, product videos and assembly instructions. See pages 288-291 for order details.

SHOWDOWNDISPLAYS.COM · ASI 87188 · PPAI 254687 · SAGE 67383 · PPPC 20101202

## GOLF UMBRELLA



Built to handle the elements, this golf umbrella offers wide coverage, durable construction and dependable performance.

- 62" arc with eight-panel construction
- Manual-open stick umbrella
- Black fiberglass shaft and ribs
- Canopy is constructed of rPET polyester
- Minimum order quantity of 25
- Not eligible for Rush Service



Shown with dye sublimation (single-sided)

### Dye Sublimation

Item #	Description	25-49	50-99	100-249	250-499
A00382	Golf Umbrella (Single-Sided)	68.65	66.05	63.25	60.40
A00383	Golf Umbrella (Double-Sided)	74.45	71.60	68.55	65.50

Setup fee: \$20(G)

Pricing is subject to change.

White fabric fully dye sublimated with full-color artwork. USD MSRP (C)  
Minimum order quantity of 25.

Closed Product Size	Arc	Finished Graphic Size	Product Wt.	Media
1"W x 39"H x 1"D	62"	view online template	31 lbs. (qty 25)	rPET polyester



Umbrella closes down to 39".



Anti-slip rubber handle matches the black fiberglass shaft and ribs.



## CHALLENGER II UMBRELLA



This must-have umbrella combines strength, reliability and sustainability for ultimate weather protection.

- 62" arc with eight-panel construction
- Manual-open stick umbrella
- Fiberglass shaft and double-rib frame
- Anti-slip rubber handle with medallion
- Closes down to 39"
- Features safety glide opening mechanism
- Solid-color canopy is constructed of rPET polyester;
- two-color canopy is constructed of rPET polyester and nylon
- Minimum order quantity of 12
- Custom options available (call for quote; restrictions may apply)



Wind vent technology allows greater airflow; can withstand winds up to 75 mph.



Shown in white/crimson with 2 locations

### Full-Color Imprint

Item #	Description	12-24	25-49	50-74	75-99
A00011	Challenger II Umbrella (1 Location)	27.51	26.68	25.86	25.31
A00012	Challenger II Umbrella (2 Locations)	28.91	28.04	27.18	26.60
A00014	Challenger II Umbrella (4 Locations)	31.71	30.76	29.81	29.17

Setup fee: \$20(G)

Pricing is subject to change.

Stock fabric colors with full-color artwork. USD MSRP (C)  
Minimum order quantity of 12.

Closed Product Size	Arc	Finished Graphic Size	Product Wt.	Media
2"W x 39"H x 2"D	62"	view online template	19.8 lbs. (qty 12)	solid-color: rPET polyester two-color: rPET polyester (white) / nylon (color)

### Stock Challenger II Umbrella Colors

- Crimson PMS 186
- Indigo PMS 295
- Black
- White/Crimson PMS 186
- White/Azure PMS 286
- White/Spruce PMS 3435
- Ruby PMS 201
- Cool Gray 11
- Black/White
- White/Ruby PMS 201
- White/Indigo PMS 295

PMS colors are for reference only and may vary slightly from actual color.

**PRICES ARE SUBJECT TO CHANGE.** No setup fee on orders placed via our website. Visit [showdowndisplays.com](http://showdowndisplays.com) for current pricing, graphic templates, product videos and assembly instructions. See pages 288-291 for order details. SHOWDOWNDISPLAYS.COM · ASI 87188 · PPAI 254687 · SAGE 67383 · PPPC 20101202

CHALLENGER II GOLF production lead time after final proof approval  
**5 -OR- 30 DAYS**



Shown in black/white with 1 location

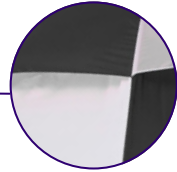

Wind vent technology allows greater airflow; can withstand winds up to 75 mph.

## CHALLENGER CHECKERBOARD PANELS UMBRELLA



This high-performance umbrella combines durability and innovation for protection against the elements!

- 62" arc with eight-panel construction
- Manual-open golf stick umbrella
- Fiberglass shaft and double-rib frame
- Canopy is constructed of rPET polyester and nylon
- Minimum order quantity of 12
- Custom options available (call for quote; restrictions may apply)

### Full-Color Imprint

Item #	Description	12-24	25-49	50-74	75-99
A00251	Challenger Checkerboard Panels Umbrella (1 Location)	26.71	25.91	25.11	24.57
A00252	Challenger Checkerboard Panels Umbrella (2 Locations)	28.07	27.23	26.39	25.82
A00254	Challenger Checkerboard Panels Umbrella (4 Locations)	30.79	29.87	28.94	28.33

Setup fee: \$20(G)

Pricing is subject to change.

Stock fabric colors with full-color artwork.  
Minimum order quantity of 12.

USD MSRP (C)

Closed Product Size	Arc	Finished Graphic Size	Product Wt.	Media
2"W x 39"H x 2"D	62"	view online template	24 lbs. (qty 12)	rPET polyester (white) / nylon (color)

### Stock Challenger Checkerboard Panels Umbrella Colors

- Black/White
- White/Crimson PMS 186
- White/Azure PMS 286
- White/Indigo PMS 295

PMS colors are for reference only and may vary slightly from actual color.



Umbrella closes down to 39".



Anti-slip rubber handle with medallion features safety glide opening mechanism.



Shown in white/crimson with 2 locations



Wind vent technology allows greater airflow; can withstand winds up to 75 mph.

## CHALLENGER ALTERNATING PANELS UMBRELLA



Engineered for superior durability, performance and ultimate rain and wind protection.

- 62" arc with eight-panel construction
- Manual-open golf stick umbrella
- Fiberglass shaft and double-rib frame
- Canopy is constructed of rPET polyester and nylon
- Minimum order quantity of 12
- Custom options available (call for quote; restrictions may apply)

### Full-Color Imprint

Item #	Description	12-24	25-49	50-74	75-99
A00241	Challenger Alternating Panels Umbrella (1 Location)	26.71	25.91	25.11	24.57
A00242	Challenger Alternating Panels Umbrella (2 Locations)	28.07	27.23	26.39	25.82
A00244	Challenger Alternating Panels Umbrella (4 Locations)	30.79	29.87	28.94	28.33

Setup fee: \$20(G)

Pricing is subject to change.

Stock fabric colors with full-color artwork.  
Minimum order quantity of 12.

USD MSRP (C)

Closed Product Size	Arc	Finished Graphic Size	Product Wt.	Media
2"W x 39"H x 2"D	62"	view online template	24 lbs. (qty 12)	rPET polyester (white) / nylon (color)

### Stock Challenger Alternating Panels Umbrella Colors

- Black/White
- White/Crimson PMS 186
- White/Azure PMS 286
- White/Indigo PMS 295

PMS colors are for reference only and may vary slightly from actual color.

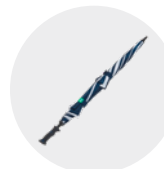

Umbrella closes down to 39".



Anti-slip rubber handle with medallion features safety glide opening mechanism.

production lead time after final proof approval

**5 DAYS**

PRICES ARE SUBJECT TO CHANGE. No setup fee on orders placed via our website.

Visit [showdowndisplays.com](http://showdowndisplays.com) for current pricing, graphic templates, product videos and assembly instructions. See pages 288-291 for order details.

SHOWDOWNDISPLAYS.COM · ASI 87188 · PPAI 254687 · SAGE 67383 · PPPC 20101202

## SPORT CHALLENGER UMBRELLA



This high-performance, virtually indestructible umbrella is designed for strength and reliability.

- 46" arc with eight-panel construction
- Auto-open folding umbrella
- Fiberglass shaft and frame
- Rubber handle with wrist strap
- Solid-color canopy is constructed of rPET polyester;
- two-color canopy is constructed of rPET polyester and nylon
- Minimum order quantity of 12
- Custom options available (call for quote; restrictions may apply)

### Full-Color Imprint

Item #	Description	12-24	25-49	50-74	75-99
A00191	Sport Challenger Umbrella (1 Location)	31.61	29.71	28.45	26.55
A00192	Sport Challenger Umbrella (2 Locations)	32.97	30.99	29.67	27.69
A00194	Sport Challenger Umbrella (4 Locations)	35.70	34.33	32.88	31.40

Setup fee: \$20(G)

Stock fabric colors with full-color artwork.  
Minimum order quantity of 12.

Pricing is subject to change.

USD MSRP (C)

Closed Product Size	Arc	Finished Graphic Size	Product Wt.	Media
2"W x 16"H x 2"D	46"	view online template	13.25 lbs. (qty 12)	solid-color: rPET polyester two-color: rPET polyester (white) / nylon (color)



Shown in white/azure with 2 locations



Wind vent technology allows greater airflow.



Umbrella folds down to 16" for portability.



Rubber handle matches the fiberglass shaft and ribs.

### Stock Sport Challenger Umbrella Colors

- Indigo PMS 295
- Black
- Black/White
- White/Crimson PMS 186
- White/Azure PMS 286
- White/Indigo PMS 295

PMS colors are for reference only and may vary slightly from actual color.

## AUTO CHALLENGER UMBRELLA



Meet the world's strongest auto-open golf umbrella. Engineered for ultimate durability and performance!

- 62" arc with eight-panel construction
- Auto-open golf stick umbrella
- Fiberglass shaft and double-rib frame
- Anti-slip rubber handle with medallion
- Closes down to 39"
- Features safety glide opening mechanism
- Solid-color canopy is constructed of rPET polyester;
- two-color canopy is constructed of rPET polyester and nylon
- Minimum order quantity of 12
- Custom options available (call for quote; restrictions may apply)

### Full-Color Imprint

Item #	Description	12-24	25-49	50-74	75-99
A00231	Auto Challenger Umbrella (1 Location)	33.25	31.97	30.62	29.24
A00232	Auto Challenger Umbrella (2 Locations)	34.61	33.28	31.88	30.44
A00234	Auto Challenger Umbrella (4 Locations)	37.33	36.21	35.09	34.34

Setup fee: \$20(G)

Stock fabric colors with full-color artwork.  
Minimum order quantity of 12.

Pricing is subject to change.

USD MSRP (C)

Closed Product Size	Arc	Finished Graphic Size	Product Wt.	Media
2"W x 39"H x 2"D	62"	view online template	23 lbs. (qty 12)	solid-color: rPET polyester two-color: rPET polyester (white) / nylon (color)



Wind vent technology allows greater airflow; can withstand winds up to 75 mph.

Shown in white/indigo with 4 locations

### Stock Auto Challenger Umbrella Colors

- Crimson PMS 186
- Ruby PMS 201
- Indigo PMS 295
- Black
- Black/White
- White/Crimson PMS 186
- White/Azure PMS 286
- White/Indigo PMS 295

PMS colors are for reference only and may vary slightly from actual color.



Shown in black with 4 locations



Unique wind vent technology features elastic stretchers and internal cutouts allow greater airflow for tough weather conditions.

**Stock Folding Challenger III Umbrella Colors**

- Indigo PMS 295
- Black

PMS colors are for reference only and may vary slightly from actual color.

**FOLDING CHALLENGER III UMBRELLA**



This high-performance, wind-resistant umbrella is built for strength, reliability and sustainability.

- 48" arc with eight-panel construction
- Auto-open folding umbrella
- Steel shaft and fiberglass ribs
- Anti-slip, color-matched rubber handle with wrist strap
- Canopy constructed with rPET polyester
- Minimum order quantity of 12
- Custom options available (call for quote; restrictions may apply)

**Full-Color Imprint**

Item #	Description	12-24	25-49	50-74	75-99
A00201	Folding Challenger III Umbrella (1 Location)	31.50	30.29	29.01	27.70
A00202	Folding Challenger III Umbrella (2 Locations)	32.86	31.59	30.26	28.90
A00204	Folding Challenger III Umbrella (4 Locations)	35.59	34.22	32.78	31.30

Setup fee: \$20(G)

Pricing is subject to change.

Stock fabric colors with full-color artwork. Minimum order quantity of 12.

USD MSRP (C)

Closed Product Size	Arc	Finished Graphic Size	Product Wt.	Media
1.5"W x 18"H x 1.5"D	48"	view online template	14.5 lbs. (qty 12)	rPET polyester



Umbrella folds down to 18" for portability.

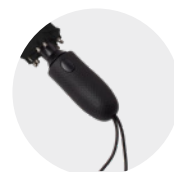

Auto-open button is easily accessible on an anti-slip, rubber coated, plastic handle.



Shown with 2 locations

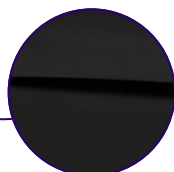

Wind vent technology allows greater airflow; can withstand winds up to 75 mph.

**SQUARE CHALLENGER UMBRELLA**



This high-performance umbrella combines durability, innovation and sustainability for weather protection.

- 68" arc (PGA size) with four-panel construction
- Manual-open golf stick umbrella
- Fiberglass shaft and double-rib frame
- Canopy constructed with rPET polyester
- Minimum order quantity of 12
- Custom options available (call for quote; restrictions may apply)

**Full-Color Imprint**

Item #	Description	12-24	25-49	50-74	75-99
A00361	Square Challenger Umbrella (1 Location)	32.16	30.92	29.62	28.28
A00362	Square Challenger Umbrella (2 Locations)	33.52	32.23	30.87	29.48
A00364	Square Challenger Umbrella (4 Locations)	36.24	35.15	34.07	33.34

Setup fee: \$20(G)

Pricing is subject to change.

Black with full-color artwork. Minimum order quantity of 12.

USD MSRP (C)

Closed Product Size	Arc	Finished Graphic Size	Product Wt.	Media
1"W x 39"H x 1"D	68"	view online template	22 lbs. (qty 12)	rPET polyester



Umbrella closes down to 39".



Unique square shape keeps you protected from the elements.



Anti-slip rubber handle with medallion features safety glide opening mechanism.

production lead time after final proof approval

**5 DAYS**

**PRICES ARE SUBJECT TO CHANGE.** No setup fee on orders placed via our website.

Visit [showdowndisplays.com](http://showdowndisplays.com) for current pricing, graphic templates, product videos and assembly instructions. See pages 288-291 for order details.

SHOWDOWNDISPLAYS.COM · ASI 87188 · PPAI 254687 · SAGE 67383 · PPPC 20101202

## SPORT & STREET UMBRELLA



This versatile and eco-friendly umbrella offers full-size coverage making it perfect for everyday use.

- 48" arc with eight-panel construction
- Auto-open stick umbrella
- Solid-color canopy is constructed of rPET polyester;
- two-color canopy is constructed of rPET polyester and nylon
- Minimum order quantity of 12
- Laser engraved handle and other custom options available (call for quote; restrictions may apply)



Shown in white/spruce with 4 locations

### Full-Color Imprint

Item #	Description	12-24	25-49	50-74	75-99
A00161	Sport & Street Umbrella (1 Location)	13.08	12.69	12.30	12.03
A00162	Sport & Street Umbrella (2 Locations)	14.44	14.01	13.57	13.28
A00164	Sport & Street Umbrella (4 Locations)	17.17	16.65	16.14	15.80

Setup fee: \$20(G)

Pricing is subject to change.

Stock fabric colors with full-color artwork.  
Minimum order quantity of 12.

USD MSRP (C)

Closed Product Size	Arc	Finished Graphic Size	Product Wt.	Media
1.5"W x 32"H x 1.5"D	48"	view online template	12.6 lbs. (qty 12)	solid-color: rPET polyester two-color: rPET polyester (white) / nylon (color)



Umbrella closes down to 32".



Hardwood handle stands out against the black steel shaft and ribs.

### Stock Sport & Street Umbrella Colors

- White
- Azure PMS 286
- Spruce PMS 3435
- Black
- White/Crimson PMS 186
- White/Azure PMS 286
- White/Spruce PMS 3435
- Ruby PMS 201
- Indigo PMS 295
- Cool Gray 11
- Black/White
- White/Ruby PMS 201
- White/Indigo PMS 295

PMS colors are for reference only and may vary slightly from actual color.

## CHAMP II UMBRELLA



This high-performance umbrella is designed for superior coverage and durability, making it a must-have for golfers, outdoor enthusiasts and everyday use!

- 58" arc with eight-panel construction
- Auto-open, folding, golf umbrella
- Multi-patented steel shaft and fiberglass ribs
- Anti-slip rubber handle
- Folds down to 22.5"
- Solid-color canopy is constructed of rPET polyester;
- two-color canopy is constructed of rPET polyester and nylon
- Minimum order quantity of 12
- Custom options available (call for quote; restrictions may apply)



Wind vent technology allows greater airflow.

Shown in white/crimson with 4 locations

### Full-Color Imprint

Item #	Description	12-24	25-49	50-74	75-99
A00051	Champ II Umbrella (1 Location)	31.44	30.50	29.55	28.92
A00052	Champ II Umbrella (2 Locations)	32.84	31.85	30.87	30.21
A00054	Champ II Umbrella (4 Locations)	35.65	34.58	33.51	32.80

Setup fee: \$20(G)

Pricing is subject to change.

Stock fabric colors with full-color artwork.  
Minimum order quantity of 12.

USD MSRP (C)

Closed Product Size	Arc	Finished Graphic Size	Product Wt.	Media
2"W x 22.5"H x 2"D	58"	view online template	20 lbs. (qty 12)	solid-color: rPET polyester two-color: rPET polyester (white) / nylon (color)

### Stock Champ II Umbrella Colors

- Indigo PMS 295
- Black
- White/Crimson PMS 186
- White/Indigo PMS 295
- Spruce PMS 3435
- Black/White
- White/Azure PMS 286

PMS colors are for reference only and may vary slightly from actual color.



Shown with 1 location

## PARK AVENUE 1 UMBRELLA



This sophisticated and strong umbrella is designed for those who appreciate quality, style and function.

- 44" arc with eight-panel construction
- Auto-open folding umbrella
- Hexagon steel shaft and fiberglass ribs
- Cherry wood handle with wrist strap
- Features windproof frame
- Heather gray canopy constructed with rPET polyester
- Minimum order quantity of 12
- Laser engraved handle and other custom options available (call for quote; restrictions may apply)

### Full-Color Imprint

Item #	Description	12-24	25-49	50-74	75-99
A00101	Park Avenue 1 Umbrella (1 Location)	17.99	16.91	16.19	15.11
A00102	Park Avenue 1 Umbrella (2 Locations)	19.35	18.19	17.42	16.25
A00104	Park Avenue 1 Umbrella (4 Locations)	22.07	20.75	19.86	18.54

**Setup fee: \$20(G)**

**Pricing is subject to change.**

Heather gray with full-color artwork.  
Minimum order quantity of 12.

USD MSRP (C)

Closed Product Size	Arc	Finished Graphic Size	Product Wt.	Media
1.5"W x 13.5"H x 1.5"D	44"	view online template	11 lbs. (qty 12)	rPET polyester



Umbrella folds down to 13.5" for portability.



Auto-open button is easily accessible on the cherry wood handle.



Shown with 4 locations

Wind vent technology allows greater airflow.

## PARK AVENUE 2 UMBRELLA



A polished umbrella that combines elegance with functionality.

- 46" arc with eight-panel construction
- Auto-open folding umbrella
- Steel shaft and fiberglass ribs
- Cherry wood handle with wrist strap
- Heather gray canopy constructed with rPET polyester
- Minimum order quantity of 12
- Laser engraved handle and other custom options available (call for quote; restrictions may apply)

### Full-Color Imprint

Item #	Description	12-24	25-49	50-74	75-99
A00111	Park Avenue 2 Umbrella (1 Location)	26.16	24.59	23.54	21.97
A00112	Park Avenue 2 Umbrella (2 Locations)	27.52	25.87	24.77	23.12
A00114	Park Avenue 2 Umbrella (4 Locations)	30.25	28.44	27.23	25.41

**Setup fee: \$20(G)**

**Pricing is subject to change.**

Heather gray with full-color artwork.  
Minimum order quantity of 12.

USD MSRP (C)

Closed Product Size	Arc	Finished Graphic Size	Product Wt.	Media
1.5"W x 16"H x 1.5"D	46"	view online template	16 lbs. (qty 12)	rPET polyester



Umbrella folds down to 16" for portability.



Auto-open button is easily accessible on the cherry wood handle.

production lead time after final proof approval

**5 DAYS**

## PARK AVENUE 3 UMBRELLA



An upscale and durable umbrella designed with style and innovation in mind.

- 58" arc with eight-panel construction
- Auto-open folding umbrella
- Black steel shaft and fiberglass ribs
- Cherry wood handle with wrist strap
- Heather gray canopy constructed with rPET polyester
- Minimum order quantity of 12
- Laser engraved handle and other custom options available (call for quote; restrictions may apply)



Wind vent technology allows greater airflow.

Shown with 2 locations

### Full-Color Imprint

Item #	Description	12-24	25-49	50-74	75-99
A00121	Park Avenue 3 Umbrella (1 Location)	31.07	30.14	29.21	28.58
A00122	Park Avenue 3 Umbrella (2 Locations)	32.43	31.46	30.48	29.84
A00124	Park Avenue 3 Umbrella (4 Locations)	35.15	34.10	33.04	32.34

Setup fee: \$20(G)

Pricing is subject to change.

Heather gray with full-color artwork.  
Minimum order quantity of 12.

USD MSRP (C)

Closed Product Size	Arc	Finished Graphic Size	Product Wt.	Media
2"W x 22.5"H x 2"D	58"	view online template	21 lbs. (qty 12)	rPET polyester



Umbrella folds down to 22.5" for portability.



Auto-open button is easily accessible on the cherry wood handle.

## PARK AVENUE 4 UMBRELLA



This luxurious and reliable umbrella combines quality and innovation with style!

- 46" arc with eight-panel construction
- Auto-open inverted stick umbrella
- Steel with ABS plastic shaft and fiberglass ribs
- Cherry wood handle with wrist strap
- Closes down to 23"
- Heather gray canopy constructed with rPET polyester
- Minimum order quantity of 12
- Laser engraved handle and other custom options available (call for quote; restrictions may apply)



Features an inverted design that prevents water from dripping when closed.

Shown with 1 location

### Full-Color Imprint

Item #	Description	12-24	25-49	50-74	75-99
A00131	Park Avenue 4 Umbrella (1 Location)	25.62	24.85	24.08	23.57
A00132	Park Avenue 4 Umbrella (2 Locations)	26.98	26.17	25.36	24.82
A00134	Park Avenue 4 Umbrella (4 Locations)	29.70	28.81	27.92	27.32

Setup fee: \$20(G)

Pricing is subject to change.

Heather gray with full-color artwork.  
Minimum order quantity of 12.

USD MSRP (C)

Closed Product Size	Arc	Finished Graphic Size	Product Wt.	Media
2.5"W x 23"H x 2.5"D	46"	view online template	18.6 lbs. (qty 12)	rPET polyester

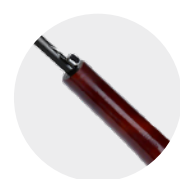

Auto-open button is easily accessible on the cherry wood handle.



Shown with 1 location



Features an inverted design that prevents water from dripping when closed.



Auto-open/close button is easily accessible on the cherry wood handle.

## PARK AVENUE 5 UMBRELLA



Designed for effortless use, its auto-open and close function allows for a smooth, one-handed operation.

- 46" arc with eight-panel construction
- Auto-open/close inverted folding umbrella
- Chromed steel shaft and fiberglass ribs
- Cherry wood handle with wrist strap
- Folds down to 12"
- Heather gray canopy constructed with rPET polyester
- Minimum order quantity of 12
- Laser engraved handle and other custom options available (call for quote; restrictions may apply)

### Full-Color Imprint

Item #	Description	12-24	25-49	50-74	75-99
A00141	Park Avenue 5 Umbrella (1 Location)	24.53	23.79	23.06	22.57
A00142	Park Avenue 5 Umbrella (2 Locations)	25.89	25.11	24.34	23.82
A00144	Park Avenue 5 Umbrella (4 Locations)	28.61	27.75	26.89	26.32

Setup fee: \$20(G)

Pricing is subject to change.

Heather gray with full-color artwork.  
Minimum order quantity of 12.

USD MSRP (C)

Closed Product Size	Arc	Finished Graphic Size	Product Wt.	Media
2.5"W x 12"H x 2.5"D	46"	view online template	13.5 lbs. (qty 12)	rPET polyester

## LUXE UMBRELLA



This timeless, high-end umbrella seamlessly blends luxury with performance, making it the perfect choice for those who appreciate both style and functionality.

- 48" arc with eight-panel construction
- Auto-open stick umbrella
- Dark mahogany wood shaft and fiberglass ribs
- Canopy is constructed of rPET polyester
- Minimum order quantity of 12
- Laser engraved handle and other custom options available (call for quote; restrictions may apply)

### Full-Color Imprint

Item #	Description	12-24	25-49	50-74	75-99
A00281	Luxe Umbrella (1 Location)	28.89	27.78	26.61	25.41
A00282	Luxe Umbrella (2 Locations)	30.25	29.09	27.86	26.60
A00284	Luxe Umbrella (4 Locations)	32.97	31.70	30.37	29.00

Setup fee: \$20(G)

Pricing is subject to change.

Stock fabric colors with full-color artwork.  
Minimum order quantity of 12.

USD MSRP (C)

Closed Product Size	Arc	Finished Graphic Size	Product Wt.	Media
4"W x 36"H x 2"D	48"	view online template	18 lbs. (qty 12)	rPET polyester



Shown in cool gray 11 with 2 locations



Wind vent technology allows greater airflow.

### Stock Luxe Umbrella Colors

- Cool Gray 11
- Black

PMS colors are for reference only and may vary slightly from actual color.



Umbrella closes down to 36".



Curved wood handle with wood-tone accents.

production lead time after final proof approval

**5 DAYS**

**PRICES ARE SUBJECT TO CHANGE.** No setup fee on orders placed via our website.

Visit [showdowndisplays.com](http://showdowndisplays.com) for current pricing, graphic templates, product videos and assembly instructions. See pages 288-291 for order details.

SHOWDOWNDISPLAYS.COM · ASI 87188 · PPAI 254687 · SAGE 67383 · PPPC 20101202

## CLASSIC FASHION UMBRELLA



This high-quality umbrella combines classic appeal with modern sustainability, making it a reliable choice for any occasion.

- 48" arc with eight-panel construction
- Manual-open stick umbrella
- Steel shaft and fiberglass ribs
- Canopy constructed with rPET polyester
- Minimum order quantity of 12
- Custom options available (call for quote; restrictions may apply)

### Full-Color Imprint

Item #	Description	12-24	25-49	50-74	75-99
A00351	Classic Fashion Umbrella (1 Location)	14.72	14.15	13.56	12.95
A00352	Classic Fashion Umbrella (2 Locations)	16.08	15.46	14.81	14.14
A00354	Classic Fashion Umbrella (4 Locations)	18.80	18.24	17.67	17.30

Setup fee: \$20(G)

Pricing is subject to change.

Stock fabric colors with full-color artwork. USD MSRP (C)  
Minimum order quantity of 12.

Closed Product Size	Arc	Finished Graphic Size	Product Wt.	Media
4"W x 36"H x 2"D	48"	view online template	10.25 lbs. (qty 12)	rPET polyester



### Stock Classic Fashion Umbrella Colors

- Indigo PMS 295
- Black

PMS colors are for reference only and may vary slightly from actual color.



Umbrella closes down to 36".



Features a black hardwood handle.

## EURO FASHION UMBRELLA



Experience classic European style with a sleek and eco-friendly design. The umbrella where fashion meets function, rain or shine!

- 48" arc with eight-panel construction
- Auto-open stick umbrella
- Wood shaft and fiberglass ribs
- Canopy constructed with rPET polyester
- Minimum order quantity of 12
- Custom options available (call for quote; restrictions may apply)

### Full-Color Imprint

Item #	Description	12-24	25-49	50-74	75-99
A00371	Euro Fashion Umbrella (1 Location)	18.86	17.73	16.97	15.84
A00372	Euro Fashion Umbrella (2 Locations)	20.22	19.01	18.20	16.98
A00374	Euro Fashion Umbrella (4 Locations)	22.94	22.06	21.13	20.18

Setup fee: \$20(G)

Pricing is subject to change.

Stock fabric colors with full-color artwork. USD MSRP (C)  
Minimum order quantity of 12.

Closed Product Size	Arc	Finished Graphic Size	Product Wt.	Media
4"W x 36"H x 2"D	48"	view online template	12.5 lbs. (qty 12)	rPET polyester



Shown in black with 1 location

### Stock Euro Fashion Umbrella Colors

- Indigo PMS 295
- Black

PMS colors are for reference only and may vary slightly from actual color.

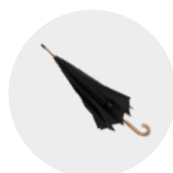

Umbrella closes down to 36".



Wood shaft and curved handle are made from one-piece of wood.



## ZION UMBRELLA



This refined and durable umbrella is the perfect blend of style, functionality and sustainability.

- 44" arc with eight-panel construction
- Auto-open folding umbrella
- Black steel shaft and black fiberglass ribs
- Cherry wood handle with wrist strap
- Canopy constructed with rPET polyester
- Minimum order quantity of 12
- Custom options available (call for quote; restrictions may apply)

### Full-Color Imprint

Item #	Description	12-24	25-49	50-74	75-99
A00061	Zion Umbrella (1 Location)	16.35	15.72	15.06	14.38
A00062	Zion Umbrella (2 Locations)	17.71	17.18	16.65	16.29
A00064	Zion Umbrella (4 Locations)	20.44	19.83	19.21	18.80

Setup fee: \$20(G)

Pricing is subject to change.

Stock fabric colors with full-color artwork.  
Minimum order quantity of 12.

USD MSRP (C)

Closed Product Size	Arc	Finished Graphic Size	Product Wt.	Media
2.25"W x 14"H x 2.25"D	44"	view online template	11 lbs. (qty 12)	rPET polyester

### Stock Zion Umbrella Colors

● Indigo PMS 295

● Black

*PMS colors are for reference only and may vary slightly from actual color.*



Umbrella folds down to 14" for portability.



Auto-open button is easily accessible on the cherry wood handle.

## HURRICANE UMBRELLA



This wind-resistant umbrella offers unbeatable value.

- 60" arc with eight-panel construction
- Auto-open stick umbrella
- Fiberglass shaft and ribs
- Solid-color canopy is constructed of rPET polyester;
- Two-color canopy is constructed of rPET polyester and nylon
- Minimum order quantity of 12
- Custom options available (call for quote; restrictions may apply)

### Full-Color Imprint

Item #	Description	12-24	25-49	50-74	75-99
A00091	Hurricane Umbrella (1 Location)	20.71	19.47	18.64	17.40
A00092	Hurricane Umbrella (2 Locations)	22.07	20.75	19.86	18.54
A00094	Hurricane Umbrella (4 Locations)	24.80	23.85	22.84	21.81

Setup fee: \$20(G)

Pricing is subject to change.

Stock fabric colors with full-color artwork.  
Minimum order quantity of 12.

USD MSRP (C)

Closed Product Size	Arc	Finished Graphic Size	Product Wt.	Media
2.5"W x 37"H x 2.5"D	60"	view online template	19.2 lbs. (qty 12)	solid-color: rPET polyester two-color: rPET polyester (white) / nylon (color)



Shown in crimson with 2 locations

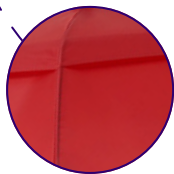

Wind vent technology allows greater airflow.

### Stock Hurricane Umbrella Colors

● Crimson PMS 186

● Azure PMS 286

● Indigo PMS 295

● Black

● Black/White

● White/Crimson PMS 186

● White/Azure PMS 286

● White/Indigo PMS 295

*PMS colors are for reference only and may vary slightly from actual color.*



This golf stick umbrella closes down to 37".



Auto-open button is easily accessible above the rubber grip handle.

production lead time after final proof approval

**5 DAYS**

**PRICES ARE SUBJECT TO CHANGE.** No setup fee on orders placed via our website.

Visit [showdowndisplays.com](http://showdowndisplays.com) for current pricing, graphic templates, product videos and assembly instructions. See pages 288-291 for order details.

SHOWDOWNDISPLAYS.COM · ASI 87188 · PPAI 254687 · SAGE 67383 · PPPC 20101202

## JINGLEBRELLA™



This unique promotional umbrella is designed to leave a lasting impression with its innovative features and premium construction.

- 50" arc with eight-panel construction
- Auto-open stick umbrella
- Black steel shaft and fiberglass ribs
- Features patented technology to play a custom sound bit when opened (MP3 file not included)
- Purchase requires signed Terms of Use & Liability Waiver Agreement
- Requires 2 AAA batteries (included)
- Canopy constructed with rPET polyester
- Minimum order quantity of 12
- Custom options available (call for quote; restrictions may apply)



### Full-Color Imprint

Item #	Description	12-24	25-49	50-74	75-99
A00341	JingleBrella™ (1 Location)	69.00	66.95	64.85	63.50
A00342	JingleBrella™ (2 Locations)	70.35	68.25	66.15	64.75
A00344	JingleBrella™ (4 Locations)	73.10	70.90	68.70	67.25

#### Setup fee: \$20(G)

Black with full-color artwork.  
Minimum order quantity of 12.

#### Pricing is subject to change.

USD MSRP (C)

Closed Product Size	Arc	Finished Graphic Size	Product Wt.	Media
1"W x 33"H x 1"D	50"	view online template	16 lbs. (qty 12)	rPET polyester



## SPOTLIGHT UMBRELLA



This one-of-a-kind umbrella seamlessly blends functionality, durability and high-tech lighting for an exceptional weather protection experience.

- 50" arc with eight-panel construction
- Auto-open stick umbrella
- Black steel shaft and black fiberglass ribs
- Requires 3 AAA batteries (included)
- Canopy constructed with rPET polyester
- Black canopy with light gray interior
- Minimum order quantity of 12
- Custom options available (call for quote; restrictions may apply)



### Full-Color Imprint

Item #	Description	12-24	25-49	50-74	75-99
A00001	Spotlight Umbrella (1 Location)	42.51	41.23	39.96	39.11
A00002	Spotlight Umbrella (2 Locations)	43.87	42.55	41.24	40.36
A00004	Spotlight Umbrella (4 Locations)	46.60	45.20	43.80	42.87

#### Setup fee: \$20(G)

Black with full-color artwork.  
Minimum order quantity of 12.

#### Pricing is subject to change.

USD MSRP (C)

Closed Product Size	Arc	Finished Graphic Size	Product Wt.	Media
1"W x 33"H x 1"D	50"	view online template	17.6 lbs. (qty 12)	rPET polyester



**PRICES ARE SUBJECT TO CHANGE.** No setup fee on orders placed via our website.

Visit [showdowndisplays.com](http://showdowndisplays.com) for current pricing, graphic templates, product videos and assembly instructions. See pages 288-291 for order details.

SHOWDOWNDISPLAYS.COM · ASI 87188 · PPPI 254687 · SAGE 67383 · PPPC 20101202

production lead time  
after final proof approval  
**5 DAYS**



Shown in black  
4 locations

## REDWOOD UMBRELLA



This refined and durable umbrella is designed for both everyday use and corporate branding.

- 46" arc with eight-panel construction
- Auto-open stick umbrella
- Steel shaft and fiberglass ribs
- Canopy constructed with rPET polyester
- Minimum order quantity of 12
- Laser engraved handle and other custom options available (call for quote; restrictions may apply)

### Full-Color Imprint

Item #	Description	12-24	25-49	50-74	75-99
A00071	Redwood Umbrella (1 Location)	17.44	16.92	16.39	16.04
A00072	Redwood Umbrella (2 Locations)	18.80	18.24	17.67	17.30
A00074	Redwood Umbrella (4 Locations)	21.53	20.88	20.24	19.81

**Setup fee: \$20(G)**

**Pricing is subject to change.**

Stock fabric colors with full-color artwork.  
Minimum order quantity of 12.

USD MSRP (C)

Closed Product Size	Arc	Finished Graphic Size	Product Wt.	Media
1.75"W x 33"H x 1.75"D	46"	view online template	10.5 lbs. (qty 12)	rPET polyester

### Stock Redwood Umbrella Colors

- Indigo PMS 295
- Black

PMS colors are for reference only and may vary slightly from actual color.



Umbrella closes down to 33".



Auto-open button is easily accessible above the wood handle.



Shown in cool gray 11  
with 1 location

## FREEDOM UMBRELLA



This lightweight umbrella offers protection without the bulk.

- 46" arc with eight-panel construction
- Auto-open/close folding umbrella
- Steel shaft and ribs
- Rubber coated plastic handle with wrist strap
- Wind vent technology allows greater airflow
- Canopy is constructed of rPET polyester
- Minimum order quantity of 12
- Custom options available (call for quote; restrictions may apply)

### Full-Color Imprint

Item #	Description	12-24	25-49	50-74	75-99
A00021	Freedom Umbrella (1 Location)	26.71	25.68	24.60	23.49
A00022	Freedom Umbrella (2 Locations)	28.07	26.99	25.85	24.69
A00024	Freedom Umbrella (4 Locations)	30.79	29.60	28.36	27.08

**Setup fee: \$20(G)**

**Pricing is subject to change.**

Stock fabric colors with full-color artwork.  
Minimum order quantity of 12.

USD MSRP (C)

Closed Product Size	Arc	Finished Graphic Size	Product Wt.	Media
2.5"W x 12"H x 2.5"D	46"	view online template	12 lbs. (qty 12)	rPET polyester



Patented safety shaft that locks in any position preventing accidental collapse.



Umbrella folds down to 12" for portability.



Auto-open/close button is easily accessible on the rubber coated plastic handle.

### Stock Freedom Umbrella Colors

- Indigo PMS 295
- Cool Gray 11
- Black

PMS colors are for reference only and may vary slightly from actual color.

production lead time  
after final proof approval

**5 DAYS**

**PRICES ARE SUBJECT TO CHANGE.** No setup fee on orders placed via our website. Visit [showdowndisplays.com](http://showdowndisplays.com) for current pricing, graphic templates, product videos and assembly instructions. See pages 288-291 for order details.

SHOWDOWNDISPLAYS.COM · ASI 87188 · PPAI 254687 · SAGE 67383 · PPPC 20101202



Rebel 2 shown in black/crimson with full-color imprint (4 locations)



Rebel 2 is an auto-open, stick umbrella that closes down to 34.5".

## REBEL 2 AND REBEL 3 UMBRELLAS



These stylish and eco-conscious umbrellas are designed for ultimate convenience and protection.

- 46" arc with eight-panel construction
- Fiberglass shaft and ribs
- Rubber grip handle with wrist strap
- Features an inverted design that prevents water from dripping when closed
- Canopy constructed with rPET polyester
- Minimum order quantity of 12 for full-color imprint; 25 for dye sublimation
- Custom options available (call for quote; restrictions may apply)
- Dye sublimation is not eligible for Rush Service

### Full-Color Imprint

Item #	Description	12-24	25-49	50-74	75-99
A00171	Rebel 2 Umbrella (1 Location)	22.89	22.20	21.52	21.06
A00172	Rebel 2 Umbrella (2 Locations)	24.25	23.52	22.80	22.31
A00174	Rebel 2 Umbrella (4 Locations)	26.98	26.17	25.36	24.82

Setup fee: \$20(G)

Pricing is subject to change.

Stock fabric colors with full-color artwork. USD MSRP (C)  
Minimum order quantity of 12.

Closed Product Size	Arc	Finished Graphic Size	Product Wt.	Media
2.5"W x 34.5"H x 2.5"D	46"	view online template	18.25 lbs. (qty 12)	rPET polyester

### Dye Sublimation

Item #	Description	25-49	50-99	100-249	250-499
A00384	Rebel 2 Umbrella (Double-Sided)	57.25	55.05	52.70	50.35

Setup fee: \$20(G)

Pricing is subject to change.

White fabric fully dye sublimated with full-color artwork. USD MSRP (C)  
Minimum order quantity of 25.

Closed Product Size	Arc	Finished Graphic Size	Product Wt.	Media
2.5"W x 34.5"H x 2.5"D	46"	view online template	38 lbs. (qty 25)	rPET polyester

#### Stock Rebel 2 Umbrella Colors

- Black
- Black/Crimson PMS 186
- Black/Azure PMS 286

PMS colors are for reference only and may vary slightly from actual color.



Rebel 3 shown in black/azure with full-color imprint (1 location)



Rebel 3 is an auto-open/close, folding umbrella that folds down to 12" for portability.

### Full-Color Imprint

Item #	Description	12-24	25-49	50-74	75-99
A00181	Rebel 3 Umbrella (1 Location)	22.35	21.68	21.01	20.56
A00182	Rebel 3 Umbrella (2 Locations)	23.71	23.00	22.29	21.81
A00184	Rebel 3 Umbrella (4 Locations)	26.43	25.64	24.84	24.32

Setup fee: \$20(G)

Pricing is subject to change.

Stock fabric colors with full-color artwork. USD MSRP (C)  
Minimum order quantity of 12.

Closed Product Size	Arc	Finished Graphic Size	Product Wt.	Media
2.5"W x 12"H x 2.5"D	46"	view online template	13.25 lbs. (qty 12)	rPET polyester

#### Stock Rebel 3 Umbrella Colors

- Black
- Black/Crimson PMS 186
- Black/Azure PMS 286
- Black/Lime Green PMS 375
- Black/Cool Gray 11

PMS colors are for reference only and may vary slightly from actual color.

**PRICES ARE SUBJECT TO CHANGE.** No setup fee on orders placed via our website. Visit [showdowndisplays.com](http://showdowndisplays.com) for current pricing, graphic templates, product videos and assembly instructions. See pages 288-291 for order details. SHOWDOWNDISPLAYS.COM · ASI 87188 · PPAI 254687 · SAGE 67383 · PPPC 20101202

IMPRINT DYE-SUB production lead time after final proof approval  
**5-OR-30 DAYS**



Shown in cool gray 11 with 4 locations

## CEO UMBRELLA



Sleek, smart and eco-friendly, this 46" arc umbrella offers ample coverage while boasting lightweight durability.

- 46" arc with eight-panel construction
- Auto-open/close folding umbrella
- Aluminum shaft and fiberglass ribs
- Canopy is constructed with rPET polyester
- Minimum order quantity of 12
- Custom options available (call for quote; restrictions may apply)

### Full-Color Imprint

Item #	Description	12-24	25-49	50-74	75-99
A00211	CEO Umbrella (1 Location)	23.44	22.54	21.59	20.62
A00212	CEO Umbrella (2 Locations)	24.80	23.85	22.84	21.81
A00214	CEO Umbrella (4 Locations)	27.52	26.46	25.35	24.20

Setup fee: \$20(G)

Pricing is subject to change.

Stock fabric colors with full-color artwork. Minimum order quantity of 12.

USD MSRP (C)

Closed Product Size	Arc	Finished Graphic Size	Product Wt.	Media
4"W x 13"H x 2"D	46"	view online template	13.25 lbs. (qty 12)	rPET polyester

### Stock CEO Umbrella Colors

- Cool Gray 11
- Black

PMS colors are for reference only and may vary slightly from actual color.



Umbrella folds down to 13" for portability.



Auto-open/close button is easily accessible on the curved, faux wood handle.



Shown with 2 locations

Wind vent technology allows greater airflow.

## JUDGE UMBRELLA



This expertly designed umbrella offers a perfect blend of durability and convenience, making it a must-have for any weather condition.

- 54" arc with eight-panel construction
- Auto-open/close folding umbrella
- Nickel-plated steel shaft and fiberglass ribs
- Hard plastic and faux wood grain handle with wrist strap
- Features patented safety shaft that locks in any position preventing accidental collapse, reducing strain and enhancing safety
- Canopy is constructed of rPET polyester
- Minimum order quantity of 12
- Custom options available (call for quote; restrictions may apply)

### Full-Color Imprint

Item #	Description	12-24	25-49	50-74	75-99
A00311	Judge Umbrella (1 Location)	28.67	27.57	26.41	25.22
A00312	Judge Umbrella (2 Locations)	30.03	28.87	27.66	26.41
A00314	Judge Umbrella (4 Locations)	32.75	31.49	30.16	28.80

Setup fee: \$20(G)

Pricing is subject to change.

Black with full-color artwork. Minimum order quantity of 12.

USD MSRP (C)

Closed Product Size	Arc	Finished Graphic Size	Product Wt.	Media
2.5"W x 15"H x 2.5"D	54"	view online template	15 lbs. (qty 12)	rPET polyester



Umbrella folds down to 15" for portability.



Auto-open/close button is easily accessible on the rubber and wood grain handle.

production lead time after final proof approval

**5 DAYS**

**PRICES ARE SUBJECT TO CHANGE.** No setup fee on orders placed via our website.

Visit [showdowndisplays.com](http://showdowndisplays.com) for current pricing, graphic templates, product videos and assembly instructions. See pages 288-291 for order details.

SHOWDOWNDISPLAYS.COM · ASI 87188 · PPAI 254687 · SAGE 67383 · PPPC 20101202

## MADISON UMBRELLA



This sleek and reliable umbrella seamlessly combines functionality, portability and sustainability, making it a perfect everyday essential.

- 46" arc with eight-panel construction
- Auto-open/close folding umbrella
- Aluminum shaft and fiberglass ribs
- Rubber handle with wrist strap
- Canopy is constructed of rPET polyester
- Minimum order quantity of 12
- Custom options available (call for quote; restrictions may apply)

### Full-Color Imprint

Item #	Description	12-24	25-49	50-74	75-99
A00221	Madison Umbrella (1 Location)	17.99	17.45	16.91	16.55
A00222	Madison Umbrella (2 Locations)	19.35	18.77	18.19	17.80
A00224	Madison Umbrella (4 Locations)	22.07	21.41	20.75	20.30

Setup fee: **\$20(G)** Pricing is subject to change.  
 Stock fabric colors with full-color artwork. USD MSRP (C)  
 Minimum order quantity of 12.

Closed Product Size	Arc	Finished Graphic Size	Product Wt.	Media
2"W x 12"H x 2"D	46"	view online template	11 lbs. (qty 12)	rPET polyester



### Stock Madison Umbrella Colors

- Indigo PMS 295
- Black
- Cool Gray 11

*PMS colors are for reference only and may vary slightly from actual color.*



Umbrella folds down to 12" for portability.



Auto-open/close button is easily accessible on the rubber handle.

## DUKE UMBRELLA



This sleek and travel-friendly umbrella is designed for reliability, convenience and sustainability.

- 44" arc with eight-panel construction
- Auto-open/close folding umbrella
- Steel shaft and fiberglass ribs
- Black and gun-metal rubber handle with wrist strap
- Canopy is constructed with rPET polyester
- Minimum order quantity of 12
- Custom options available (call for quote; restrictions may apply)

### Full-Color Imprint

Item #	Description	12-24	25-49	50-74	75-99
A00031	Duke Umbrella (1 Location)	17.17	16.51	15.81	15.10
A00032	Duke Umbrella (2 Locations)	18.53	17.97	17.42	17.05
A00034	Duke Umbrella (4 Locations)	21.26	20.62	19.98	19.56

Setup fee: **\$20(G)** Pricing is subject to change.  
 Stock fabric colors with full-color artwork. USD MSRP (C)  
 Minimum order quantity of 12.

Closed Product Size	Arc	Finished Graphic Size	Product Wt.	Media
1.5"W x 11"H x 1.5"D	44"	view online template	9.6 lbs. (qty 12)	rPET polyester



Shown in indigo with 4 locations

Features ultralight windproof reflex frame.

### Stock Duke Umbrella Colors

- Indigo PMS 295
- Black
- Gray PMS 423

*PMS colors are for reference only and may vary slightly from actual color.*



Umbrella folds down to 11" for portability.



Auto-open/close button is easily accessible on the black and gun-metal rubber handle.



Shown in white/azure with 2 locations

Unique elastic stretcher with internal cutouts for added wind resistance.



Umbrella closes down to 40".



Anti-slip, color-matched, rubber handle features safety glide opening mechanism.

## GALE FORCE GOLF UMBRELLA



Designed for maximum protection, this umbrella provides the ultimate coverage against the elements.

- 64" arc with eight-panel construction
- Manual-open golf stick umbrella
- Fiberglass shaft and double-rib frame
- Wind vent technology allows greater airflow; can withstand winds up to 75 mph
- Solid-color canopy is constructed of rPET polyester; two-color canopy is constructed of rPET polyester and nylon
- Minimum order quantity of 12
- Custom options available (call for quote; restrictions may apply)

### Full-Color Imprint

Item #	Description	12-24	25-49	50-74	75-99
A00291	Gale Force Golf Umbrella (1 Location)	33.25	31.97	30.62	29.24
A00292	Gale Force Golf Umbrella (2 Locations)	34.61	33.28	31.88	30.44
A00294	Gale Force Golf Umbrella (4 Locations)	37.33	36.21	35.09	34.34

Setup fee: \$20(G)

Pricing is subject to change.

Stock fabric colors with full-color artwork. Minimum order quantity of 12.

USD MSRP (C)

Closed Product Size	Arc	Finished Graphic Size	Product Wt.	Media
2"W x 40"H x 2"D	64"	view online template	21.75 lbs. (qty 12)	solid-color: rPET polyester two-color: rPET polyester (white) / nylon (color)

### Stock Gale Force Golf Umbrella Colors

- Indigo PMS 295
  - Black
  - White/Crimson PMS 186
  - White/Azure PMS 286
- PMS colors are for reference only and may vary slightly from actual color.*

## SUPER WINDY UMBRELLA



Elegant, durable and built to weather any storm.

- 46" arc with eight-panel construction
- Auto-open folding umbrella
- Hexagon steel shaft and fiberglass ribs
- Wood handle with dark nickel accents and wrist strap
- Wind vent technology allows greater airflow
- Solid-color canopy is constructed of rPET polyester; two-color canopy is constructed of rPET polyester and nylon
- Minimum order quantity of 12
- Laser engraved handle and other custom options available (call for quote; restrictions may apply)



Shown in white/crimson with 4 locations

Umbrella folds down to 18" for portability.

### Stock Super Windy Umbrella Colors

- Indigo PMS 295
  - Black
  - White/Crimson PMS 186
  - White/Azure PMS 286
- PMS colors are for reference only and may vary slightly from actual color.*

### Full-Color Imprint

Item #	Description	12-24	25-49	50-74	75-99
A00151	Super Windy Umbrella (1 Location)	17.44	16.92	16.39	16.04
A00152	Super Windy Umbrella (2 Locations)	18.80	18.24	17.67	17.30
A00154	Super Windy Umbrella (4 Locations)	21.53	20.88	20.24	19.81

Setup fee: \$20(G)

Pricing is subject to change.

Stock fabric colors with full-color artwork. Minimum order quantity of 12.

USD MSRP (C)

Closed Product Size	Arc	Finished Graphic Size	Product Wt.	Media
1.5"W x 18"H x 1.5"D	46"	view online template	10.75 lbs. (qty 12)	solid-color: rPET polyester two-color: rPET polyester (white) / nylon (color)

production lead time after final proof approval

**5 DAYS**

**PRICES ARE SUBJECT TO CHANGE.** No setup fee on orders placed via our website.

Visit [showdowndisplays.com](http://showdowndisplays.com) for current pricing, graphic templates, product videos and assembly instructions. See pages 288-291 for order details.

SHOWDOWNDISPLAYS.COM · ASI 87188 · PPAI 254687 · SAGE 67383 · PPPC 20101202

## STORM 2 UMBRELLA



This 60" arc umbrella is designed for superior coverage, making it the perfect companion.

- 60" arc with eight-panel construction
- Manual-open golf stick umbrella
- Fiberglass shaft and ribs
- Solid-color canopy is constructed of rPET polyester;
- two-color canopy is constructed of rPET polyester and nylon
- Minimum order quantity of 12
- Custom options available (call for quote; restrictions may apply)

### Full-Color Imprint

Item #	Description	12-24	25-49	50-74	75-99
A00301	Storm 2 Umbrella (1 Location)	16.90	15.89	15.21	14.20
A00302	Storm 2 Umbrella (2 Locations)	18.26	17.16	16.43	15.34
A00304	Storm 2 Umbrella (4 Locations)	20.98	19.72	18.88	17.62

### Setup fee: \$20(G)

Stock fabric colors with full-color artwork.  
Minimum order quantity of 12.

### Pricing is subject to change.

USD MSRP (C)

Closed Product Size	Arc	Finished Graphic Size	Product Wt.	Media
2"W x 39"H x 2"D	60"	view online template	15.5 lbs. (qty 12)	solid-color: rPET polyester two-color: rPET polyester (white) / nylon (color)



Umbrella closes down to 39".



Blonde hardwood handle features safety glide opening mechanism.



Shown in white/pumpkin with 1 location

### Stock Storm 2 Umbrella Colors

- White
- Ruby PMS 201
- Indigo PMS 295
- Gray PMS 423
- Black/White
- White/Crimson PMS 186
- White/Azure PMS 286
- White/Spruce PMS 3435
- Crimson PMS 186
- Azure PMS 286
- Spruce PMS 3435
- Black
- White/Pumpkin PMS 165
- White/Ruby PMS 201
- White/Indigo PMS 295

PMS colors are for reference only and may vary slightly from actual color.

## MINI UMBRELLAS



These compact yet durable umbrellas are designed for ultimate convenience and reliability.

- Canopy is constructed with rPET polyester
- Minimum order quantity of 12
- Custom options available (call for quote; restrictions may apply)

### Full-Color Imprint

Item #	Description	12-24	25-49	50-74	75-99
A00271	Super Flat Mini Umbrella (1 Location)	17.99	17.45	16.91	16.55
A00272	Super Flat Mini Umbrella (2 Locations)	19.35	18.77	18.19	17.80
A00273	Super Flat Mini Umbrella (3 Locations)	20.71	20.09	19.47	19.05

### Setup fee: \$20(G)

Stock fabric colors with full-color artwork.  
Minimum order quantity of 12.

### Pricing is subject to change.

USD MSRP (C)

Closed Product Size	Arc	Finished Graphic Size	Product Wt.	Media
1.5"W x 10.5"H x 1.5"D	43"	view online template	9 lbs. (qty 12)	rPET polyester

### Full-Color Imprint

Item #	Description	12-24	25-49	50-74	75-99
A00261	Super Pocket Mini Umbrella (1 Location)	17.99	16.91	16.19	15.11
A00262	Super Pocket Mini Umbrella (2 Locations)	19.35	18.19	17.42	16.25
A00263	Super Pocket Mini Umbrella (3 Locations)	20.71	19.47	18.64	17.40

### Setup fee: \$20(G)

Stock fabric colors with full-color artwork.  
Minimum order quantity of 12.

### Pricing is subject to change.

USD MSRP (C)

Closed Product Size	Arc	Finished Graphic Size	Product Wt.	Media
1.5"W x 11"H x 1.5"D	43"	view online template	9.75 lbs. (qty 12)	rPET polyester



Shown in indigo with 2 locations

### Super Flat Mini

- 43" arc with six-panel construction
- Auto-open/close folding umbrella
- Aluminum shaft and fiberglass ribs
- Rubber handle with wrist strap
- Folds down to 10.5"
- Wind vent technology allows greater airflow

### Super Flat Mini Umbrella Stock Colors

- Indigo PMS 295
- Black



Shown in crimson with 1 location

### Super Pocket Mini

- 43" arc with six-panel construction
- Auto-open/close folding umbrella
- Aluminum shaft and ribs
- Rubber handle with wrist strap
- Folds down to 11"

### Super Pocket Mini Umbrella Stock Colors

- Crimson PMS 186
- Indigo PMS 295
- Black
- Cool Gray 11

PRICES ARE SUBJECT TO CHANGE. No setup fee on orders placed via our website. Visit [showdowndisplays.com](http://showdowndisplays.com) for current pricing, graphic templates, product videos and assembly instructions. See pages 288-291 for order details.

SHOWDOWNDISPLAYS.COM · ASI 87188 · PPAI 254687 · SAGE 67383 · PPPC 20101202

production lead time  
after final proof approval  
**5 DAYS**



# LIFESTYLE & EVENTS

1. Compact Folding Wagon page 183 2. TrashWorks Wrap page 184 3. Kettle Grill page 179 4. Barricade Cover page 185  
5. Nighttime Cornhole page 167 6. Smash Paddle Set page 170

## have you considered...

- **context** what kind of image are you trying to convey at your event?
- **longevity** do you plan to use the product more than once?
- **size** how large is your event space?
- **audience** how many people are you trying to accommodate?
- **weather** will your event be indoors or outdoors?

## how to FEATURE

Create unique experiences with games and interactive elements at any event. These fun and engaging opportunities can be shared on social media and further promote your brand. Crowd control products provide a safe environment for attendees.

## BAG TOSS GAME



Toss some friendly competition into your next event with this customizable game.

- Game includes two game boards and eight bean bags
- Durable plastic construction prevents rust and splinters
- Included rope acts as a distance regulator
- Hinged legs fold out to prop the game boards up at an angle
- 90-day warranty on graphic panels

### Bag Toss Game

Item #	Description	1	2-5	6-11	12-24
280310	Kit	308.75	302.75	299.50	293.25

Setup fee: \$20(G)

Pricing is subject to change.

Kit Includes: Hardware, 8 Unimprinted Bean Bags and 2 Graphic Panels USD MSRP (C)

Product Size	Finished Graphic Size	Product Wt.	Media
folded: 21.5"W x 2.75"H x 33.125"D (1) open: 21.5"W x 10.5"H x 32.75"D	view online template	21.5 lbs.	Titan™ no-curl laminated media



Unimprinted bean bags are available in four red and four navy.



Built-in score keepers slide up and down the edges of the board.



Bean bags can be stored inside plastic molded pockets so they don't get left behind.



Two game boards clasp together into a single unit for easy transportation.

## BAG TOSS GAME ACCESSORIES



Level up your Bag Toss competition with these essential add-ons.

- Bag Toss Buddy attaches to Bag Toss (sold separately) for access to a bag holder, score keeper and drink holder
- Personalize your bags with custom bean bags
- Custom Bean Bags are not eligible for Rush Service

### Bag Toss Game Accessories

Item #	Description	1	2-5	6-11	12-24
280314	Bag Toss Buddy Kit	69.00	67.65	66.95	65.55
280315	Custom Bean Bags (Set of 8)	121.20	118.80	117.60	115.10

Custom Bean Bags setup fee: \$20(G)

Pricing is subject to change.

Bag Toss Buddy Kit Includes: 2 Scorekeepers and Drink Holders USD MSRP (C)  
Custom Bean Bags: 8 Double-Sided Bean Bags (4 of Each Design)



Bag Toss Buddy can be attached to folded Bag Toss (sold separately) for easy portability.

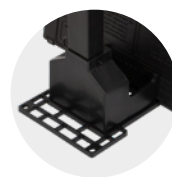

Bag Toss Buddy slides into the back of the Bag Toss (sold separately) for quick assembly.

Custom Bean Bags



Bag Toss Buddy shown with Bag Toss (sold separately)

**HARDWARE-ONLY LEAD TIME: SHIPS SAME DAY WHEN ORDERED BEFORE 2 PM CENTRAL**  
**PRICES ARE SUBJECT TO CHANGE.** No setup fee on orders placed via our website.  
Visit [showdowndisplays.com](http://showdowndisplays.com) for current pricing, graphic templates, product videos and assembly instructions. See pages 288-291 for order details.  
SHOWDOWNDISPLAYS.COM · ASI 87188 · PPAI 254687 · SAGE 67383 · PPPC 20101202

BAG TOSS BEAN BAGS production lead time after final proof approval

**3-OR-6 DAYS**



## WOOD CORNHOLE



This classic game is perfect for tailgates, company picnics and weekend get-togethers.

- Game includes two game boards and eight unimprinted or dye sublimated bean bags
- Features regulation 6" dia. holes
- Vibrant full-color decals on game board
- Decals are permanent and cannot be swapped or repositioned
- Constructed with premium-grade plywood and solid wood legs
- Dye sublimation is not eligible for Rush Service

### Wood Cornhole

Item #	Description	1	2-5	6-11	12-24
AG0158	Unimprinted Bean Bags Kit	322.25	314.00	307.75	300.75
AG0154	Dye Sublimated Bean Bags Kit	416.00	405.25	397.00	388.25

Setup fee: \$20(G)

Pricing is subject to change.

Kit Includes: Game with Applied Graphic Decals, 8 Unimprinted or Dye Sublimated Bean Bags (4 of Each Design) and Carry Case USD MSRP (C)

### Wood Cornhole Plus

Item #	Description	1	2-5	6-11	12-24
AG0159	Unimprinted Bean Bags Kit	324.50	316.00	309.75	302.75
AG0155	Dye Sublimated Bean Bags Kit	418.25	407.50	399.25	390.25

Setup fee: \$20(G)

Pricing is subject to change.

Kit Includes: Game with Applied Graphic Decals, 8 Unimprinted or Dye Sublimated Bean Bags (4 of Each Design) and Imprinted Carry Case USD MSRP (C)

Product Size	Finished Graphic Size	Product Wt.	Media (Decal)
26"W x 6"H x 49"D	view online template	46 lbs.	decals vinyl film



Unimprinted bean bags are available in combinations of white, red, royal, navy and black (four per color).



Wood Cornhole Plus has an imprinted carry case.



Shown in azure with royal and white bean bags



Carry case included for easy transport.

## PORTABLE CORNHOLE



Take your favorite game anywhere with this lightweight cornhole set perfect for on-the-go fun!

- Game includes two boards and eight bean bags
- Lightweight, portable and assembles with ease
- Available with vibrant full-color imprint on each game surface
- Constructed with a sturdy PVC frame and polyester fabric game surface
- Custom bean bags available (call for quote; restrictions may apply)

### Portable Cornhole

Item #	Description	1	2-5	6-11	12-24
AG0201	Bean Bags Kit - Black/Navy	84.35	82.20	80.55	78.70
AG0202	Bean Bags Kit - Black/Red	84.35	82.20	80.55	78.70
AG0203	Bean Bags Kit - Black/Royal	84.35	82.20	80.55	78.70
AG0204	Bean Bags Kit - Black/White	84.35	82.20	80.55	78.70
AG0205	Bean Bags Kit - Navy/Red	84.35	82.20	80.55	78.70
AG0206	Bean Bags Kit - Navy/Royal	84.35	82.20	80.55	78.70
AG0207	Bean Bags Kit - Navy/White	84.35	82.20	80.55	78.70
AG0208	Bean Bags Kit - Red/Royal	84.35	82.20	80.55	78.70
AG0209	Bean Bags Kit - Red/White	84.35	82.20	80.55	78.70
AG0210	Bean Bags Kit - Royal/White	84.35	82.20	80.55	78.70

Setup fee: \$20(G)

Pricing is subject to change.

Kit Includes: Imprinted Game and 8 Unimprinted Bean Bags USD MSRP (C)

Product Size	Finished Graphic Size	Product Wt.
24"W x 10"H x 36"D	view online template	13 lbs.

#### Stock Portable Cornhole Colors

- White
- Azure PMS 286
- Crimson PMS 186

PMS colors are for reference only and may vary slightly from actual color.

production lead time after final proof approval

**7 DAYS**

**PRICES ARE SUBJECT TO CHANGE.** No setup fee on orders placed via our website. Visit [showdowndisplays.com](http://showdowndisplays.com) for current pricing, graphic templates, product videos and assembly instructions. See pages 288-291 for order details.

SHOWDOWNDISPLAYS.COM · ASI 87188 · PPAI 254687 · SAGE 67383 · PPPC 20101202

## NIGHTTIME CORNHOLE



### Light up the night with this lighted cornhole game!

- Game includes two game boards and eight unimprinted or dye sublimated bean bags
- Features programmable LED lights around the board that come in seven vibrant colors
- Regulation 6" dia. holes
- Requires three AA batteries per board (not included)
- Vibrant full-color decals on game board
- Decals are permanent and cannot be swapped or repositioned
- Constructed with premium-grade plywood and solid wood legs
- Dye sublimation is not eligible for Rush Service

### Nighttime Cornhole

Item #	Description	1	2-5	6-11	12-24
AG0124	Unimprinted Bean Bags Kit	344.25	335.25	328.50	321.25
AG0156	Dye Sublimated Bean Bags Kit	438.00	426.50	418.00	408.50

Setup fee: \$20(G)

Pricing is subject to change.

Kit Includes: Game with Applied Graphic Decals, 8 Unimprinted or Dye Sublimated Bean Bags (4 of Each Design) and Carry Case USD MSRP (C)

### Nighttime Cornhole Plus

Item #	Description	1	2-5	6-11	12-24
AG0125	Unimprinted Bean Bags Kit	347.00	338.00	331.25	323.75
AG0157	Dye Sublimated Bean Bags Kit	440.75	429.25	420.75	411.25

Setup fee: \$20(G)

Pricing is subject to change.

Kit Includes: Game with Applied Graphic Decals, 8 Unimprinted or Dye Sublimated Bean Bags (4 of Each Design) and Imprinted Carry Case USD MSRP (C)

Product Size	Finished Graphic Size	Product Wt.	Media (Decal)
24"W x 6"H x 48"D	view online template	46 lbs.	decal vinyl film



Shown with dye sublimated bean bags



Nighttime Cornhole Plus has an imprinted carry case.



Unimprinted bean bags are available in combinations of white, red, royal, navy and black (four per color).

## CORNHOLE COOLER



### Where fun meets refreshment, this cornhole just got cooler.

- Includes one board, four bean bags and 35 liter capacity cooler
- Removable cornhole board can be used on cooler or ground
- Constructed with durable plastic
- Vibrant full-color decals
- Decals are permanent and cannot be swapped or repositioned
- Custom bean bags available (call for quote; restrictions may apply)

### Cornhole Cooler

Item #	Description	1	2-5	6-11	12-24
AG0281	Top Decal Kit	189.40	184.50	180.80	176.70
AG0282	Top and Sides Decal Kit	211.40	205.90	201.80	197.30

Setup fee: \$20(G)

Pricing is subject to change.

Kit Includes: Game with Applied Graphic Decal(s) and 4 Unimprinted Bean Bags USD MSRP (C)

Product Size	Finished Graphic Size	Product Wt.	Media
16.75"W x 14.5"H x 24.5"D	view online template	12 lbs.	decal vinyl film



Shown with top decal



Bean bags included in black and white.



Holds up to 40 standard 12 oz. cans with ice.



Lid features four built-in cupholders.

**PRICES ARE SUBJECT TO CHANGE.** No setup fee on orders placed via our website. Visit [showdowndisplays.com](http://showdowndisplays.com) for current pricing, graphic templates, product videos and assembly instructions. See pages 288-291 for order details. SHOWDOWNDISPLAYS.COM · ASI 87188 · PPAI 254687 · SAGE 67383 · PPPC 20101202

production lead time after final proof approval  
**7 DAYS**

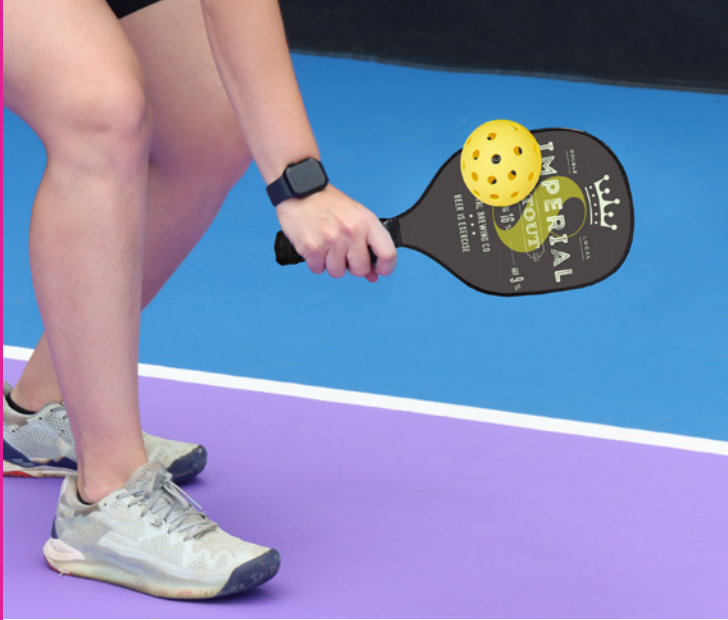

## PICKLEBALL SET



Ready, set, smash! The ultimate portable paddles for America's fastest growing sport!

- Set includes two paddles and two outdoor balls
- Paddles are constructed with wood
- Vibrant full-color decals on paddles
- Decals are permanent and cannot be swapped or repositioned

### Pickleball Set

Item #	Description	1	2-5	6-11	12-24
AG0171	Single-Sided Kit	52.35	49.72	47.20	43.35
AG0172	Double-Sided Kit	63.35	60.15	57.10	52.45

**Setup fee: \$20(G)**

**Pricing is subject to change.**

Kit Includes: 2 Single- or Double-Sided Decaled Paddles, 2 Outdoor Pickleball Balls and Carry Case

USD MSRP (C)

### Pickleball Set Plus

Item #	Description	1	2-5	6-11	12-24
AG0173	Single-Sided Kit	55.10	52.35	49.68	45.63
AG0174	Double-Sided Kit	66.10	62.75	59.60	54.75

**Setup fee: \$20(G)**

**Pricing is subject to change.**

Kit Includes: 2 Single- or Double-Sided Decaled Paddles, 2 Outdoor Pickleball Balls and Imprinted Carry Case

USD MSRP (C)

Product Size	Finished Graphic Size	Product Wt.	Media (Decal)
8"W x 16"H x 3"D	view online template	2 lbs.	decal vinyl film



Pickleball Set Plus has an imprinted carry case.



Deluxe Pickleball Set Plus (Single-Sided)

Deluxe Pickleball Set Plus has an imprinted carry case.

## DELUXE PICKLEBALL SET



Elevate your game with our fiberglass paddles crafted for better performance!

- Set includes two paddles and four outdoor balls
- Paddles are constructed with fiberglass
- Vibrant full-color decals on paddles
- Decals are permanent and cannot be swapped or repositioned

### Deluxe Pickleball Set

Item #	Description	1	2-5	6-11	12-24
AG0001	Single-Sided Kit	92.95	89.60	87.25	85.40
AG0002	Double-Sided Kit	104.00	100.20	97.55	95.55

**Setup fee: \$20(G)**

**Pricing is subject to change.**

Kit Includes: 2 Single- or Double-Sided Decaled Paddles, 4 Outdoor Pickleball Balls and Carry Case

USD MSRP (C)

### Deluxe Pickleball Set Plus

Item #	Description	1	2-5	6-11	12-24
AG0003	Single-Sided Kit	95.70	92.25	89.80	87.95
AG0004	Double-Sided Kit	106.70	102.90	100.10	98.05

**Setup fee: \$20(G)**

**Pricing is subject to change.**

Kit Includes: 2 Single- or Double-Sided Decaled Paddles, 4 Outdoor Pickleball Balls and Imprinted Carry Case

USD MSRP (C)

Product Size	Finished Graphic Size	Product Wt.	Media (Decal)
7.8"W x 15.75"H x 0.57"D	view online template	2 lbs.	decal vinyl film



front



back

### Add-On

Carry all your pickleball gear in the Pickleball Carry Bag (sold separately).

Available with full-color front imprint or embroidery; see page 213.

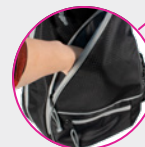

## PICKLEBALL SET WITH NET



### Everything you need to start the game.

- Game includes two paddles, two outdoor balls, steel poles and net
- Paddles are constructed with wood
- Net is 12"W x 35"H
- Available with full-color decal(s) on paddles; option for a double-sided imprint on net
- Decals are permanent and cannot be swapped or repositioned
- Assembly required

### Pickleball Set with Net

Item #	Description	1	2-5	6-11	12-24
AG0181	Single-Sided Paddle Kit	173.30	164.50	156.20	143.50
AG0182	Double-Sided Paddle Kit	184.30	174.90	166.10	152.60

Setup fee: \$20(G)

Pricing is subject to change.

Kit Includes: 2 Single- or Double-Sided Decaled Paddles, 2 Outdoor Pickleball Balls, Net and Carry Case USD MSRP (C)

### Pickleball Set with Imprinted Net

Item #	Description	1	2-5	6-11	12-24
AG0183	Single-Sided Paddle Kit	178.80	169.70	161.10	148.00
AG0184	Double-Sided Paddle Kit	189.80	180.20	171.10	157.10

Setup fee: \$20(G)

Pricing is subject to change.

Kit Includes: 2 Single- or Double-Sided Decaled Paddles, 2 Outdoor Pickleball Balls, Imprinted Net and Carry Case USD MSRP (C)

### Pickleball Set Plus with Net

Item #	Description	1	2-5	6-11	12-24
AG0185	Single-Sided Paddle Kit	176.00	167.10	158.70	145.70
AG0186	Double-Sided Paddle Kit	187.00	177.60	168.60	154.80

Setup fee: \$20(G)

Pricing is subject to change.

Kit Includes: 2 Single- or Double-Sided Decaled Paddles, 2 Outdoor Pickleball Balls, Net and Imprinted Carry Case USD MSRP (C)

### Pickleball Set Plus with Imprinted Net

Item #	Description	1	2-5	6-11	12-24
AG0187	Single-Sided Paddle Kit	181.50	172.30	163.60	150.30
AG0188	Double-Sided Paddle Kit	192.50	182.80	173.50	159.40

Setup fee: \$20(G)

Pricing is subject to change.

Kit Includes: 2 Single- or Double-Sided Decaled Paddles, 2 Outdoor Pickleball Balls, Imprinted Net and Imprinted Carry Case USD MSRP (C)

**Product Size**      **Finished Graphic Size**      **Product Wt.**      **Media (Decal)**  
 paddles: 8"W x 16"H x 3"D      view online template      15 lbs.      decal vinyl film  
 net: 12"W x 35"H



Pickleball Set with Imprinted Net (Single-Sided)



Plus options have an imprinted carry case.

## INDOOR/OUTDOOR PICKLEBALL BALLS



### Rain or shine, customize your game with extra pickleball balls for any forecast!

- Vibrant full-color imprint
- Indoor balls have 26 holes; outdoor balls have 40 holes for better aerodynamics in the wind

### Indoor/Outdoor Pickleball Balls

Item #	Description	1	2-5	6-11	12-24
AG0071	Kit	24.86	23.60	22.41	20.58
AG0072	Plus Kit	27.61	26.22	24.89	22.86

Setup fee: \$20(G)

Pricing is subject to change.

Kit Includes: 3 Indoor and 3 Outdoor Imprinted Balls and Mesh Carry Case  
 Plus Kit Includes: 3 Indoor and 3 Outdoor Imprinted Balls and Imprinted Mesh Carry Case USD MSRP (C)

**Product Size**      **Finished Graphic Size**      **Product Wt.**  
 7"W x 11"H x 3"D      view online template      0.4 lb.

Includes three indoor balls and three outdoor balls.



Pickleball Set Plus has an imprinted carry case.

**PRICES ARE SUBJECT TO CHANGE.** No setup fee on orders placed via our website. Visit [showdowndisplays.com](http://showdowndisplays.com) for current pricing, graphic templates, product videos and assembly instructions. See pages 288-291 for order details. SHOWDOWNDISPLAYS.COM · ASI 87188 · PPAI 254687 · SAGE 67383 · PPPC 20101202

production lead time after final proof approval  
**7 DAYS**



double-sided



Easily transport your two paddles and balls in the mesh carry case.

## SMASH PADDLE SET



Bring on the intensity with this classic beach game that is fun for all ages!

- Set includes two paddles and two balls
- Paddles are constructed with wood
- Vibrant full-color decals on paddles
- Decals are permanent and cannot be swapped or repositioned

### Smash Paddle Set

Item #	Description	1	2-5	6-11	12-24
AG0261	Single-Sided Kit	35.86	34.05	32.33	29.69
AG0262	Double-Sided Kit	46.86	44.49	42.24	38.80

**Setup fee: \$20(G)**

**Pricing is subject to change.**

Kit Includes: 2 Single- or Double-Sided Paddles, 2 Balls and Mesh Carry Case

USD MSRP (C)

Product Size	Finished Graphic Size	Product Wt.	Media
9.25"W x 14.75"H	view online template	1 lb.	decal vinyl film

## PORTABLE TABLE TENNIS



This complete table tennis game makes a great addition to any game or break rooms!

- Game includes table, two paddles, four balls and net
- Paddles are constructed with rubber and wood; table is constructed with aluminum
- Available with vibrant full-color decal or full wrap on table
- Decals are permanent and cannot be swapped or repositioned
- Full wrap is not eligible for Rush Service

### Portable Table Tennis

Item #	Description	1	2-5	6-11	12-24
AG0241	Top Decals Kit	323.50	311.75	303.50	297.25
AG0242	Full Wrap Kit	406.00	395.25	387.50	378.75

**Setup fee: \$20(G)**

**Pricing is subject to change.**

Kit Includes: Table, Applied Graphic Decals, 2 Paddles, 4 Balls and Net

USD MSRP (C)

Product Size	Finished Graphic Size	Product Wt.	Media (Decal / Wrap)
36"W x 30"H x 72"D	view online template	29.5 lbs.	decal vinyl film / wrap vinyl



Shown with top decals



Table folds flat; convenient comfort-grip handles for easy transport.



Full wrap covers the entire table for the ultimate branding experience.

production lead time after final proof approval  
**7 DAYS**

## FLYING SAUCER GAME



Whether you're at the beach, in the backyard or tailgating, this is your go-to game for an out-of-this world adventure!

- Game includes two collapsible portable targets, two discs, rulebook and four metal stakes
- Features 9" dia. discs
- Vibrant full-color imprint targets; applied full-color decal on discs
- Decals are permanent and cannot be swapped or repositioned
- Targets are constructed with polyester; discs are constructed with plastic

### Flying Saucer Game

Item #	Description	1	2-5	6-11	12-24
AG0011	Kit	56.00	54.55	53.45	52.25

Setup fee: \$20(G)

Pricing is subject to change.

Kit Includes: 2 Imprinted Targets, 2 Decaled Discs and Carry Case USD MSRP (C)

Product Size	Finished Graphic Size	Product Wt.
15"W x 20"H x 15"D	view online template	3 lbs.



Shown in azure



Quickly pack your game away in the included carry case.

#### Stock Flying Saucer Game Colors

- Crimson PMS 186
- Azure PMS 286
- Black

PMS colors are for reference only and may vary slightly from actual color.

## WASHER TOSS GAME



The ultimate addition to your outdoor entertainment lineup!

- Game includes wood case that separates into two halves and eight washers
- Clasps securely lock the two sections together
- Features a handle for easy transport
- Applied vibrant full-color decal(s)
- Decals are permanent and cannot be swapped or repositioned
- Constructed with Birch varnished hardwood
- Plastic coated 4.375" dia. steel washers

### Washer Toss Game

Item #	Description	1	2-5	6-11	12-24
AG0304	Single-Sided Kit	101.60	99.00	97.00	94.85
AG0305	Double-Sided Kit	112.60	107.00	101.50	93.25

Setup fee: \$20(G)

Pricing is subject to change.

Kit Includes: Game with Applied Graphic Decal(s) and 8 Washers USD MSRP (C)

Product Size	Finished Graphic Size	Product Wt.	Media
15"W x 8"H x 15"D	view online template	12 lbs.	decal vinyl film



Shown single-sided with red and black washers



Washers are available in combinations of white, red, royal and black (four per color).



## REDZONE FOOTBALL TOSS



The ultimate game for football fans that brings excitement and friendly competition anywhere you go.

- Game includes four inflatable footballs and air pump
- Features three holes with netting for game play on pre-printed football field graphic
- Vibrant full-color imprint on top section of football field graphic
- Constructed with a PVC frame and polyester

### RedZone Football Toss

Item #	Description	1	2-5	6-11	12-24
AG0251	Kit	135.20	131.70	129.00	126.10

Setup fee: \$20(G)

Pricing is subject to change.

Kit Includes: Game, Graphic, 4 Inflatable Footballs, Air Pump and Carry Case

USD MSRP (C)

### RedZone Football Toss Plus

Item #	Description	1	2-5	6-11	12-24
AG0252	Kit	137.70	134.10	131.40	128.40

Setup fee: \$20(G)

Pricing is subject to change.

Kit Includes: Game, Graphic, 4 Inflatable Footballs, Air Pump and Imprinted Carry Case

USD MSRP (C)

Product Size 30"W x 67"H x 30"D  
 Finished Graphic Size view online template  
 Product Wt. 10 lbs.



RedZone Football Toss Plus has an imprinted carry case.



Shown in azure

## LAWN PONG



Get ready for endless entertainment and laughs with coworkers, family and friends. Turn any gathering into a game night!

- Game includes two heavy-duty white rubber balls and 12 buckets
- Includes 5.5" dia. rubber balls and 9"H buckets
- Vibrant full-color imprint on buckets
- Constructed with plastic
- Buckets nest with balls inside for easy transport in included carry bag with shoulder strap

### Lawn Pong

Item #	Description	1	2-5	6-11	12-24
AG0091	Kit	112.10	108.10	105.20	103.00

Setup fee: \$20(G)

Pricing is subject to change.

Kit Includes: 12 Imprinted Buckets, 2 Rubber Balls, Hand Pump and Carry Bag

USD MSRP (C)

Product Size 9"Dia. x 9"H  
 Finished Graphic Size view online template  
 Product Wt. 11 lbs.



Easily transport your game with the included carry bag.

### Stock Lawn Pong Colors

- White
- Azure PMS 286
- Crimson PMS 186

PMS colors are for reference only and may vary slightly from actual color.

production lead time after final proof approval  
**7 DAYS**

## GIANT-4-IN-A-ROW



Big fun comes standard with this giant game that is perfect for bringing bold, classic competition to any event.

- Game includes board and 42 discs
- Stands 40"H
- Discs have a 4.3" dia.
- Three-piece design for quick setup and teardown
- Constructed with sturdy wood frame and base with a white finish
- Vibrant full-color imprint(s) on board and discs

### Giant-4-In-A-Row

Item #	Description	1	2-5	6-11	12-24
AG0044	Single-Sided Kit	311.75	303.75	297.75	291.00
AG0045	Double-Sided Kit	337.50	328.75	322.00	314.75

Setup fee: \$20(G)

Pricing is subject to change.

Kit Includes: Single- or Double-Sided Imprinted Game, 42 Single- or Double-Sided Imprinted Discs and Carry Case USD MSRP (C)

Product Size Finished Graphic Size Product Wt.  
41"W x 40"H x 15"D view online template 26 lbs.



Discs are available in white, red, blue and black.



Game latches closed when folded for easy storage.



Game fits inside carry case for portability.

## GIANT TUMBLE TOWER



Take your game to new heights with the Giant Tumble Tower! Built for big laughs and bold moves, it's the perfect crowd-pleaser for any event.

- Game includes 54 wood blocks
- Vibrant full-color imprint(s) available on one or both sides of blocks

### Giant Tumble Tower

Item #	Description	1	2-5	6-11	12-24
AG0051	Single-Sided Kit	170.90	166.50	163.20	159.50
AG0052	Double-Sided Kit	192.90	187.90	184.20	180.00

Setup fee: \$20(G)

Pricing is subject to change.

Kit Includes: 54 Single- or Double-Sided Imprinted Blocks and Carry Case USD MSRP (C)

### Giant Tumble Tower Plus

Item #	Description	1	2-5	6-11	12-24
AG0053	Single-Sided Kit	180.30	175.60	172.10	168.20
AG0054	Double-Sided Kit	202.30	197.00	193.10	188.70

Setup fee: \$20(G)

Pricing is subject to change.

Kit Includes: 54 Single- or Double-Sided Imprinted Blocks and Imprinted Carry Case USD MSRP (C)

Product Size Finished Graphic Size Product Wt.  
stacked: 7.5"W x 27"H x 7.5"D view online template 31 lbs.  
(1) block: 7.5"W x 1.5"H x 2.5"D



Giant Tumble Tower (double-sided)



Giant Tumble Tower Plus includes full-color imprint on carry case.



At 14"W x 20"H, this mini game is perfect for counters or tables.

## SPIN 'N WIN MINI PRIZE WHEEL



Whether you're trying to draw a crowd or simply add some entertainment, this engaging prize wheel is your go-to solution.

- Sturdy, powder-coated steel frame with rubber feet
- Central disc panel attaches magnetically and remains stationary when the wheel spins
- Wheel has a 14" dia.
- 10 customizable slots for personalized promotions

### Spin 'N Win Mini Prize Wheel

Item #	Description	1	2-5	6-11	12-24
280040	Kit	459.00	440.75	422.25	404.00

Setup fee: \$20(G)

Pricing is subject to change.

Kit Includes: Hardware, Graphic Panels and Soft Carry Case

USD MSRP (C)

Product Size	Finished Graphic Size	Product Wt.	Media
14"W x 20"H x 15"D	view online template	4.4 lbs.	Titan™ no-curl laminated media



Place this game in your space to encourage customer interactions.



A plastic clicker makes a ticking sound as the wheel spins.



## SPIN 'N WIN PRIZE WHEEL



Give your next trade show or event a creative spin.

- Powder-coated steel legs
- A plastic clicker makes a ticking sound as the wheel spins
- Central disc panel attaches magnetically and remains stationary when the wheel spins
- Wheel has a 31.5" dia.
- All graphic panels can be custom printed with your design
- Includes twelve prize panels and central disc panel

### Spin 'N Win Prize Wheel

Item #	Description	1	2-5	6-11	12-24
280104	Kit	733.00	718.50	711.00	696.50

Setup fee: \$20(G)

Pricing is subject to change.

Kit Includes: Hardware, Graphic Panels and Soft Carry Case

USD MSRP (C)

Product Size	Finished Graphic Size	Product Wt.	Media
31.25"W x 40.75"-72"H x 16"-31"D	view online template	16.5 lbs.	Titan™ no-curl laminated media



Prize wheel can be used on tabletops or as a standalone display with the legs extended.

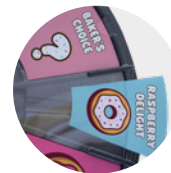

Graphic panels and central disc panel can be printed using a desktop printer.

production lead time after final proof approval

**2DAYS**

# KA' PLINK



Clink, clank, and plop your brand into the spotlight with this classic drop-style game. Perfect for prizes and promotions!

- Game includes board and six natural wood pucks
- Board is constructed with solid pine wood frame and varnished plywood center
- Portable design with back stand for support
- Vibrant full-color decal
- Decals are permanent and cannot be swapped or repositioned
- Game is constructed with PFAS free materials



## Ka' Plink

Item #	Description	1	2-5	6-11	12-24
AG0081	Kit	242.60	230.30	218.70	200.80

**Setup fee: \$20(G)**      **Pricing is subject to change.**

Kit Includes: Game with Applied Graphic Decal and Carry Case      USD MSRP (C)

## Ka' Plink Plus

Item #	Description	1	2-5	6-11	12-24
AG0082	Kit	243.90	231.60	219.90	202.00

**Setup fee: \$20(G)**      **Pricing is subject to change.**

Kit Includes: Game with Applied Graphic Decal and Imprinted Carry Case      USD MSRP (C)

Product Size	Finished Graphic Size	Product Wt.	Media (Decal)
23.6"W x 47.3"H x 34.25"D	view online template	24.5 lbs.	decals vinyl film



Ka' Plink Plus includes full-color imprint on carry case.

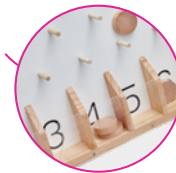

Numbers are part of the game board and are not removable.

# PUTTING GREEN TRAINER



Perfect your putt while showcasing your brand in style!

- Includes 9'L polyester mat with non-slip rubber backing
- Full-color imprint on putting green
- Three cutouts for ball storage
- Rolls up for easy storage
- Base is constructed of wood
- Automatic ball return for nonstop play
- Golf balls and putter not included



## Putting Green Trainer

Item #	Description	1	2-5	6-11	12-24
AG0061	Kit	145.50	140.30	136.60	133.70

**Setup fee: \$20(G)**      **Pricing is subject to change.**

Kit Includes: Game, Graphic and Imprinted Putting Green      USD MSRP (C)

Product Size	Finished Graphic Size	Product Wt.
15"W x 5"H x 122"D	view online template	12 lbs.



Non-slip rubber backing for safety.



Dual holes design for varying levels of difficulty.

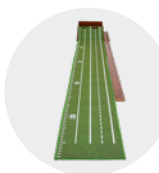

Practice your putting from over 8' away.

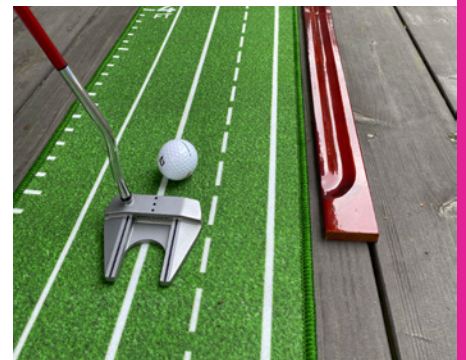

**PRICES ARE SUBJECT TO CHANGE.** No setup fee on orders placed via our website. Visit [showdowndisplays.com](http://showdowndisplays.com) for current pricing, graphic templates, product videos and assembly instructions. See pages 288-291 for order details. SHOWDOWNDISPLAYS.COM · ASI 87188 · PPAI 254687 · SAGE 67383 · PPPC 20101202

production lead time after final proof approval  
**7 DAYS**



## TABLETOP TUMBLE TOWER



Bring on the friendly competition with this classic tabletop tumble tower! Stack it high, pull carefully and let the fun fall into place!

- Game includes 54 wood blocks, wooden case and two wood dice
- Vibrant full-color imprint on lid
- Constructed with wood

### Tabletop Tumble Tower

Item #	Description	1	2-5	6-11	12-24
AG0271	Kit	24.31	23.43	22.81	22.34

Setup fee: \$20(G)

Pricing is subject to change.

Kit Includes: 54 Blocks, 2 Dice and Imprinted Wood Case

USD MSRP (C)

#### Product Size

case: 4"W x 4"H x 12"D  
(1) block: 3"W x 0.5"H x 1"D

#### Finished Graphic Size

view online template

#### Product Wt.

3 lbs.



Imprinted lid showcases your logo.



Shown with decal

## 4L MINI FRIDGE



This mini fridge keeps your essentials cool without the bulk!

- 4 liter capacity
- Constructed with plastic
- Includes AC power cord for standard U.S. outlets and a DC adapter for vehicle power ports
- Features shelf and door basket
- Cooling and warming capabilities
- Available with vibrant full-color imprint or decal
- Decals are permanent and cannot be swapped or repositioned

### 4L Mini Fridge

Item #	Description	1	2-5	6-11	12-24
AF0001	Door Decal	143.20	138.10	134.40	131.60
AF0002	Door Imprint	139.70	134.70	131.10	128.40

Setup fee: \$20(G)

Pricing is subject to change.

USD MSRP (C)

#### Product Size

7.25"W x 10.25"H x 10.75"D

#### Finished Graphic Size

view online template

#### Product Wt.

4 lbs.

#### Media (Decal)

decal vinyl film



Door easily hinges open to access the interior of the mini fridge.



Back panel includes all plugins and power options.

production lead time after final proof approval

**7 DAYS**

## 10L MINI FRIDGE



This sleek mini fridge keeps your favorites chilled!

- Cooluli Concord line fridge: 10 liter capacity
- Semiconductor cooling system provides energy-efficient and ultra-quiet operation
- Cooling and warming capabilities
- Constructed with plastic
- Includes AC power cord for standard U.S. outlets and a DC adapter for vehicle power ports
- Available with vibrant full-color imprint or decal
- Decals are permanent and cannot be swapped or repositioned

### 10L Mini Fridge

Item #	Description	1	2-5	6-11	12-24
AF0011	Door Decal	189.40	184.50	180.80	176.70
AF0012	Door Imprint	185.30	180.50	176.90	172.90

Setup fee: \$20(G)

Pricing is subject to change.

USD MSRP (C)

Product Size	Finished Graphic Size	Product Wt.	Media (Decal)
9.4"W x 13.4"H x 11.4"D	view online template	7.9 lbs.	decal vinyl film



Shown in white with decal



Features two shelves and door basket; holds up to 10 standard 12 oz. cans.



Mini fridge includes a handle for easy transport.



Available with black or white door.

#### Stock 10L Mini Fridge Colors

- White  Black

PMS colors are for reference only and may vary slightly from actual color.

## 20L MINI FRIDGE



With a larger capacity, this mini fridge keeps everything close by!

- Cooluli Concord line fridge: 20 liter capacity
- Semiconductor cooling system provides energy-efficient and ultra-quiet operation
- Cooling and warming capabilities
- Constructed with plastic
- Includes AC power cord for standard U.S. outlets and a DC adapter for vehicle power ports
- Available with vibrant full-color imprint or decal
- Decals are permanent and cannot be swapped or repositioned

### 20L Mini Fridge

Item #	Description	1	2-5	6-11	12-24
AF0021	Door Decal	351.00	342.00	335.25	327.50
AF0022	Door Imprint	346.50	337.50	330.75	323.50

Setup fee: \$20(G)

Pricing is subject to change.

USD MSRP (C)

Product Size	Finished Graphic Size	Product Wt.	Media (Decal)
11.25"W x 16.25"H x 13.75"D	view online template	13.1 lbs.	decal vinyl film



Shown in black with imprint



Available with black or white door.



Features two shelves and two door baskets for ample storage.



Exterior controls include power button and temperature settings.

#### Stock 20L Mini Fridge Colors

- White  Black

PMS colors are for reference only and may vary slightly from actual color.



Shown with wrap graphic with door decal

## 50L COUNTERTOP FRIDGE



Whether it's a quiet night in or a full house, this mini fridge is always down to chill.

- 50 liter capacity
- Cooling temperature range 32°F – 42°F
- Features adjustable shelf and LED interior lighting
- Constructed with steel and black tempered double-layered glass
- UL listed
- Vibrant full-color decal and wrap graphic; glass etching is not full-color
- Decals are permanent and cannot be swapped or repositioned
- Not eligible for Rush Service

### 50L Countertop Fridge

Item #	Description	1	2-5	6-11	12-24
AF0031	Wrap Graphic	514.00	500.50	490.75	479.50
AF0032	Wrap Graphic with Glass Etching	569.00	554.00	543.00	531.00
AF0035	Wrap Graphic with Door Decal	584.00	569.00	557.50	545.00

Setup fee: \$20(G)

Pricing is subject to change.

USD MSRP (C)

Product Size	Finished Graphic Size	Product Wt.	Media (Decal / Wrap)
18.5"W x 20"H x 17"D	view online template	43 lbs.	decal vinyl film / wrap vinyl



Glass etching maintains visibility to the inside of the fridge.



Holds up to 40 standard 12 oz. cans.



Shown with wrap graphic with glass etching

## 80L LARGE COUNTERTOP FRIDGE



Stylish and made to blend in anywhere, this mini fridge is great from dorms to office spaces.

- 80 liter capacity
- Features three adjustable shelves and LED interior lighting
- Constructed with steel and black tempered double-layered glass
- UL listed
- Vibrant full-color wrap graphic; glass etching is not full-color
- Not eligible for Rush Service

### 80L Large Countertop Fridge

Item #	Description	1	2-5	6-11	12-24
AF0041	Wrap Graphic	716.00	697.50	683.50	668.00
AF0042	Wrap Graphic with Glass Etching	771.00	751.00	736.00	719.50

Setup fee: \$20(G)

Pricing is subject to change.

USD MSRP (C)

Product Size	Finished Graphic Size	Product Wt.	Media (Wrap)
19"W x 30.75"H x 17.5"D	view online template	59 lbs.	wrap vinyl



Holds up to 100 standard 12 oz. cans.

production lead time after final proof approval

**7 DAYS**

## HIGH DOME GRILL



Elevate your outdoor cooking game with this high dome grill that is compact enough to take anywhere, yet powerful enough to impress.

- Classic charcoal grill (charcoal not included)
- Features high dome lid with air vent for temperature control
- Constructed with steel; chrome grilling grates and handle
- Vibrant full-color decal on plaque
- Decals are permanent and cannot be swapped or repositioned
- Large handle for easy transport
- Assembly required

### High Dome Grill

Item #	Description	1	2-5	6-11	12-24
AGR021	Kit	82.05	77.90	74.00	67.95

Setup fee: \$20(G)

Pricing is subject to change.

Kit Includes: Grill, Decaled Plaque and Grill Grate

USD MSRP (C)

Product Size	Finished Graphic Size	Product Wt.	Media
12"W x 17"H x 12"D	view online template	7 lbs.	decal vinyl film



Shown in azure



Air vent helps regulate the temperature while grilling.



Dome lid features a handle for easy lifting.

#### Stock High Dome Grill Colors

- Crimson PMS 186
- Azure PMS 286
- Black

PMS colors are for reference only and may vary slightly from actual color.

## KETTLE GRILL



Fire up the flavor anywhere with this classic kettle grill with a built-in logo plate for standout branding, it's the ultimate grilling companion for on-the-go promotions.

- Classic charcoal grill (charcoal not included)
- Features enameled dome lid with temperature gauge
- Ash catcher
- Constructed with steel; chrome grilling grate and handles
- Vibrant full-color decal on plate
- Decals are permanent and cannot be swapped or repositioned
- Wheels and large handle for easy transport
- Assembly required

### Kettle Grill

Item #	Description	1	2-5	6-11	12-24
AGR031	Kit	270.25	260.50	253.75	248.40

Setup fee: \$20(G)

Pricing is subject to change.

Kit Includes: Grill, Decaled Plate and Grill Grate

USD MSRP (C)

Product Size	Finished Graphic Size	Product Wt.	Media
19"W x 37.5"H x 24.5"D	view online template	19 lbs.	decal vinyl film



Shown in crimson

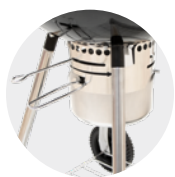

Ash catcher for easy ash disposal.



Vent helps regulate the temperature while grilling.

#### Stock Kettle Grill Colors

- Crimson PMS 186
- Azure PMS 286
- Black

PMS colors are for reference only and may vary slightly from actual color.



## GIANT TAILGATE GRILL



Transforms from compact to cookout-ready in seconds for easy transport to any event.

- Unfolds into a full-sized cooking station; fueled by charcoal (not included)
- Cook up to 12 burgers and hot dogs simultaneously
- Features chrome grilling and warming grates
- Constructed with steel
- Vibrant full-color decal
- Decals are permanent and cannot be swapped or repositioned

### Giant Tailgate Grill

Item #	Description	1	2-5	6-11	12-24
AGR011	Kit	231.00	225.00	220.50	215.50

Setup fee: \$20(G)

Pricing is subject to change.

Kit Includes: Decaled Grill, Grilling Grate and Warming Grate USD MSRP (C)

Product Size	Finished Graphic Size	Product Wt.	Media
30"W x 30"H x 32"D	view online template	35 lbs.	decal vinyl film



Folds flat for easy transport.

## TUSCANY PIZZA OVEN



Fire up artisan-style pizzas in your own backyard. Pairing durable stainless steel with a premium stone for delicious results every time.

- Cook restaurant-style pizza in seconds; fits 10" dia. pizza
- Features detachable handle to feed wood pellets into the hopper
- Removable door with handle
- Includes pizza stone
- Laser-etched artwork on stainless steel oven door
- Uses wood pellets (not included)
- Assembly required
- Not eligible for Rush Service

### Tuscany Pizza Oven

Item #	Description	1	2-5	6-11	12-24
AGR061	Kit	330.00	321.50	315.00	308.00

Setup fee: \$20(G)

Pricing is subject to change.

Kit Includes: Laser-Etched Pizza Oven, Handle and Spout USD MSRP (C)

Product Size	Finished Graphic Size	Product Wt.
16"W x 25"H x 26.625"D	view online template	33 lbs.



Use the removable door handle to open and close the oven door.



Add wood pellets into the basket at the back of the oven.



Foldable legs for easy setup and transport.

production lead time after final proof approval

**7 DAYS**

**PRICES ARE SUBJECT TO CHANGE.** No setup fee on orders placed via our website. Visit [showdowndisplays.com](http://showdowndisplays.com) for current pricing, graphic templates, product videos and assembly instructions. See pages 288-291 for order details.

SHOWDOWNDISPLAYS.COM · ASI 87188 · PPAI 254687 · SAGE 67383 · PPPC 20101202

## BBQ GRILL APRON



Keep your hands free and grill station organized with this apron.

- Includes apron, spatula, fork, tongs and mitt
- Artwork is vibrantly imprinted on rPET polyester apron
- Adjustable neck and waist straps
- Utensils are constructed with stainless steel featuring hardwood handles; mitt is constructed with insulated cotton
- Laser engraved utensil handles custom option available (call for quote; restrictions may apply)

### BBQ Grill Apron

Item #	Description	1	2-5	6-11	12-24
AGR001	Kit	42.79	40.63	38.58	35.43

Setup fee: \$20(G)

Pricing is subject to change.

Kit Includes: Imprinted Apron, Spatula, Fork, Tongs and Mitt USD MSRP (C)

Product Size	Finished Graphic Size	Product Wt.	Media
16"W x 23"H	view online template	2 lbs.	rPET polyester



Conveniently rolls up with a snap closure for compact storage.



Features multiple pockets to hold utensils.



## PATIO HEATER



Extend your outdoor seating season for your patio, restaurant or outdoor space with this 7'H heater.

- Steel patio heater heats up to 200 sq. ft.
- Automatic shutoff if tipped over
- Uses a standard 20 lb. propane or butane gas cylinder only (not included)
- Available with vibrant full-color imprint or decal
- Decals are permanent and cannot be swapped or repositioned
- Assembly required; assembles in approximately 60 minutes
- Do not leave unattended when in use
- ETL – USA certified
- Outdoor use only; maintain a clearance of 47" from combustible materials from top and sides

### Patio Heater

Item #	Description	1	2-5	6-11	12-24
APH001	Front Imprint	493.25	480.50	470.75	460.25
APH002	Front Decal	506.50	493.25	483.50	472.50

Setup fee: \$20(G)

Pricing is subject to change.

USD MSRP (C)

Product Size	Finished Graphic Size	Product Wt.	Media (Decal)
18"W x 84"H x 18"D	view online template	39 lbs.	decal vinyl film



Patio heater features a stainless flame screen.



Shown with imprint

Shown with decal

**PRICES ARE SUBJECT TO CHANGE.** No setup fee on orders placed via our website. Visit [showdowndisplays.com](http://showdowndisplays.com) for current pricing, graphic templates, product videos and assembly instructions. See pages 288-291 for order details. SHOWDOWNDISPLAYS.COM · ASI 87188 · PPAI 254687 · SAGE 67383 · PPPC 20101202

production lead time after final proof approval  
**7 DAYS**



## PORTABLE FIRE PIT



Bring the heat wherever you go with this portable fire pit. Lightweight, durable, it's made for warmth, grilling and standout branding.

- Lightweight and rust-resistant
- Constructed with steel
- Includes grill grate and fire poker
- Features ember screen for safety
- Vibrant full-color decal on plaque
- Decals are permanent and cannot be swapped or repositioned

### Portable Fire Pit

Item #	Description	1	2-5	6-11	12-24
AGR041	Kit	270.25	260.50	253.75	248.40

**Setup fee: \$20(G)** **Pricing is subject to change.**

Kit Includes: Fire Pit, Decaled Plaque, Ember Screen, Grill Grate, Fire Poker and Soft Carry Case USD MSRP (C)

Product Size	Finished Graphic Size	Product Wt.	Media
26"W x 19"H x 26"D	view online template	19 lbs.	decal vinyl film



Fire pit folds into carry case for easy transport.



Decaled plaque is connected to the fire pit by hooks and chains.



Legs are secured to the base with a pin.



## STAINLESS STEEL FIRE PIT



Bring the heat without the hassle. This sleek stainless steel fire pit delivers a warm, glowing fire.

- Laser-etched artwork on stainless steel
- Innovative design provides a full fire while reducing smoke output
- Uses firewood or wood pellets (not included)
- Includes heat-resistant gloves
- Removable handles for positioning
- Carry case for portability and storage
- Not eligible for Rush Service



Stainless Steel Fire Pit Plus includes full-color imprint on carry case.

### Stainless Steel Fire Pit

Item #	Description	1	2-5	6-11	12-24
AGR051	Kit	385.00	375.00	367.50	359.25

**Setup fee: \$20(G)** **Pricing is subject to change.**

Kit Includes: Laser-Etched Fire Pit and Soft Carry Case USD MSRP (C)

### Stainless Steel Fire Pit Plus

Item #	Description	1	2-5	6-11	12-24
AGR052	Kit	394.25	384.00	376.50	368.00

**Setup fee: \$20(G)** **Pricing is subject to change.**

Kit Includes: Laser-Etched Fire Pit and Imprinted Soft Carry Case USD MSRP (C)

Product Size	Finished Graphic Size	Product Wt.
15"W x 16"H x 15"D	view online template	21 lbs.



Connect handles to the base by placing them in the bottom holes.



production lead time after final proof approval

**7 DAYS**



## NIGHTLIFE SPEAKER



The ultimate party guest! It's there to have fun, turn up the volume and steal the spotlight.

- Inflatable, high quality Bluetooth speaker
- Vivid full-color imprint
- Easily pair two Nightlife Speakers together via automatic Bluetooth pairing
- IP66 waterproof; dust-tight and protected against high-pressure water (not rated for submersion)

### Nightlife Speaker

Item #	Description	1	2-5	6-11	12-24
ASP001	Kit	61.25	59.70	58.50	57.15

**Setup fee: \$20(G)** Pricing is subject to change.

Kit Includes: Imprinted Speaker and Charging Cable USD MSRP (C)

**Product Size** 6.7"W x 6.1"H x 6.7"D  
**Finished Graphic Size** view online template  
**Product Wt.** 1 lb.



Solar-powered with 7 LED light modes.



Includes tri-adapter: USB to iPhone, USB-C and Micro USB.

## COMPACT FOLDING WAGON



Ready when you are, this wagon rolls out for any adventure and packs down in seconds for hassle-free storage.

- Supports up to 176 lbs.
- Frame is constructed with steel
- Artwork is vibrantly printed on strong rPET Oxford cloth
- Features two built-in cupholders and two swivel wheels
- Telescoping handle hinges for easy transport
- The included soft case slides over the wagon when it's fully collapsed

### Compact Folding Wagon

Item #	Description	1	2-5	6-11	12-24
AW0001	Imprint (1 Location) Kit	209.10	203.70	199.60	195.10
AW0004	Imprint (2 Locations) Kit	213.10	207.60	203.40	198.80

**Setup fee: \$20(G)** Pricing is subject to change.

Kit Includes: Imprinted Wagon and Soft Carry Case USD MSRP (C)

### Compact Folding Wagon Plus

Item #	Description	1	2-5	6-11	12-24
AW0002	Imprint (1 Location) Kit	213.50	208.00	203.80	199.20
AW0005	Imprint (2 Locations) Kit	217.10	211.50	207.20	202.60

**Setup fee: \$20(G)** Pricing is subject to change.

Kit Includes: Imprinted Wagon and Imprinted Soft Carry Case USD MSRP (C)

**Product Size** 18"W x 22"H x 36"D  
**Finished Graphic Size** view online template  
**Product Wt.** 30 lbs.  
**Media** rPET oxford cloth



Compact Folding Wagon Plus includes full-color imprint on carry case.

Shown in crimson with 1 location

#### Stock Compact Folding Wagon Colors

- Crimson PMS 186
- Midnight PMS 2965
- Black

PMS colors are for reference only and may vary slightly from actual color.



55-gallon

44-gallon

32-gallon



Simply place the graphic over the lip to secure to the trash can.



Graphic stretches over trash can to provide a unique branding opportunity.



## TRASHWORKS WRAP



A unique branding solution to cover drab trash cans and increase branding advertising at your next event.

- Provides a clean, polished, fitted look
- Artwork is vibrantly dye sublimated on two-way stretch fabric
- Stretches over the bottom and around the top rim of the trash can (trash can not included)
- Great for indoor and outdoor use

### TrashWorks Wrap

Item #	Description	Product Wt.	1	2-5	6-11	12-24
271140	32-Gallon	0.4 lb.	116.60	113.10	109.60	106.10
271141	44-Gallon	0.8 lb.	123.10	119.40	115.70	112.00
271142	55-Gallon	0.8 lb.	129.70	125.80	121.90	118.00

Setup fee: \$20(G)

Pricing is subject to change.

USD MSRP (C)



36"W x 46"H

## SELFIE FRAME



Photo ops have never been more fun! Selfie frames create real-world opportunities for truly viral social media campaigns.

- Constructed of 4 mm corrugated plastic
- Corrugated plastic is much stronger than cardboard, so the frame won't sag or flop
- Available single-sided only
- Corrugated plastic can be recycled after use

### Selfie Frame

Item #	Description	Product Wt.	1	2-5	6-11	12-24
271130	18"W x 24"H	0.25 lb.	18.30	17.93	17.75	17.39
271131	24"W x 36"H	0.5 lb.	27.58	27.03	26.75	26.20
271132	36"W x 46"H	1 lb.	48.30	47.33	46.85	45.89

Setup fee: \$20(G)

Pricing is subject to change.

USD MSRP (C)



36" x 46" size is scored in back so it can be folded for shipping, and it features clear tabs to hold it together.

TRASHWORKS SELFIE production lead time after final proof approval  
**4-OR-3 DAYS**

**PRICES ARE SUBJECT TO CHANGE.** No setup fee on orders placed via our website. Visit [showdowndisplays.com](http://showdowndisplays.com) for current pricing, graphic templates, product videos and assembly instructions. See pages 288-291 for order details.

SHOWDOWNDISPLAYS.COM · ASI 87188 · PPAI 254687 · SAGE 67383 · PPPC 20101202



## EUROFIT BARRICADE



Turn your crowd-control barricade into an informational and advertisement opportunity!

- Artwork is dye sublimated on recycled polyester knit
- 100% recycled media is made with fibers recycled from plastic bottles
- Graphic cover slips over the frame like a pillowcase
- Lightweight aluminum frame; wide feet for added stability
- Not compatible with EuroFit Connector or other EuroFit accessories

### EuroFit Barricade

Item #	Description	1	2-5	6-11	12-24
263550	Kit	359.00	346.25	333.50	320.75

**Setup fee: \$20(G)** **Pricing is subject to change.**

Kit Includes: Hardware, Graphic Cover and Soft Carry Case USD MSRP (C)

Product Size	Finished Graphic Size	Product Wt.	Media
80.875"W x 42.125"H x 14.125"D	view online template	12.4 lbs.	recycled polyester knit



Break down your barricade and easily transport it in the included soft carry case.



## BARRICADE COVER



Transform your event barricade into a prime advertising opportunity.

- Covers the full barricade (barricade not included)
- Available in two-way stretch fabric (made in the USA) or Titan™ 18 oz. opaque scrim vinyl
- Hook-and-loop fasteners secure the cover
- Custom sizes and other media options available (call for quote; restrictions may apply)
- Barricade Covers used outdoors have a 90-day warranty; Barricade Covers used indoors have a 1-year warranty



3' x 7'

### Barricade Cover

Item #	Description	Product Wt.	1	2-5	6-11	12-24
302090	3' x 7' Two-Way Stretch Fabric Cover	1.8 lbs.	324.25	314.50	304.75	295.00
302091	3' x 7' 18 oz. Opaque Scrim Vinyl Cover	3.8 lbs.	309.75	300.50	291.25	282.00
302092	3' x 8' Two-Way Stretch Fabric Cover	2.2 lbs.	337.00	326.75	316.75	306.50
302093	3' x 8' 18 oz. Opaque Scrim Vinyl Cover	4.4 lbs.	324.25	314.50	304.75	295.00
302094	3' x 10' Two-Way Stretch Fabric Cover	2.8 lbs.	352.75	342.25	331.75	321.00
302095	3' x 10' 18 oz. Opaque Scrim Vinyl Cover	5.4 lbs.	337.00	326.75	316.75	306.50

**Setup fee: \$20(G)** **Pricing is subject to change.**

USD MSRP (C)

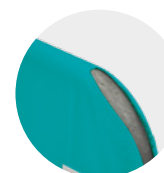

Covers are curved and open along the corners.

**PRICES ARE SUBJECT TO CHANGE.** No setup fee on orders placed via our website. Visit [showdowndisplays.com](http://showdowndisplays.com) for current pricing, graphic templates, product videos and assembly instructions. See pages 288-291 for order details. SHOWDOWNDISPLAYS.COM · ASI 87188 · PPAI 254687 · SAGE 67383 · PPPC 20101202

EUROFIT COVER production lead time after final proof approval  
**4-OR-3 DAYS**

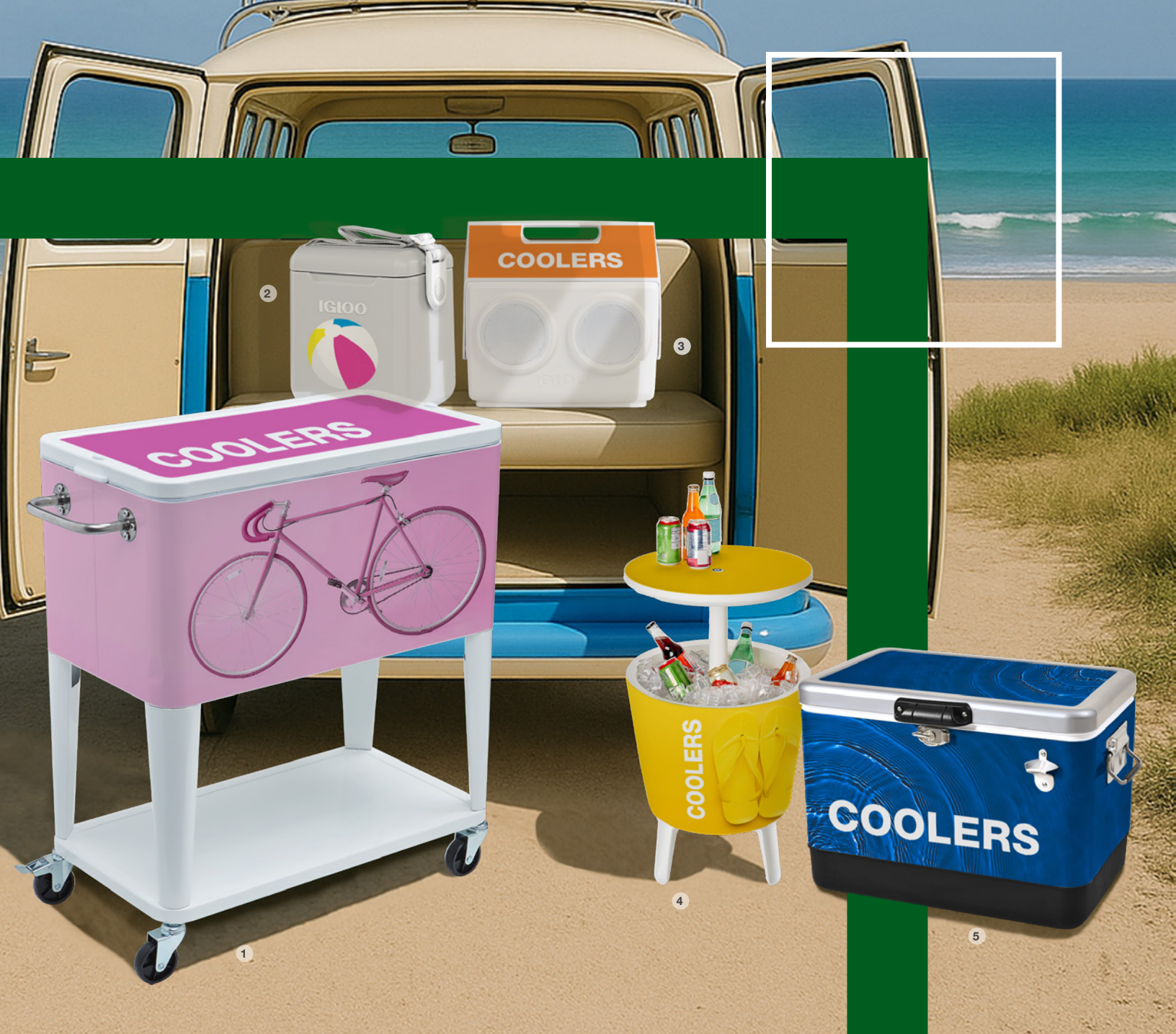

# COOLERS

1. Raise the Bar Cooler page 201 2. IGLOO® Tag Along Too Cooler page 187 3. IGLOO® KoolTunes Cooler page 188  
4. 45L Cool Bar page 200 5. Sasquatch 54QT Cooler page 195

## have you considered...

- **location** will this be used for an event or an in-store display?
- **transport** how will this cooler be transported?
- **size** how large does your cooler need to be?
- **longevity** do you require a lightweight or heavy-duty cooler?
- **accessories** do you need built-in bottle openers or wheels?

## how to FEATURE

Branded coolers are a unique premium item that are great for corporate gifting, event swag or customer loyalty programs. These high-valued products, that double as mobile advertisements, make your company memorable and appreciated.

## IGLOO® PLAYMATE ELITE COOLER



Iconic and versatile, this cooler keeps food and drinks cold with style and grab-and-go ease.

- 16 qt capacity
- Trademarked tent-top design swings open to either side
- Push-button lid for easy access
- Constructed with durable plastic
- Available in a variety of full-color imprint(s) and/or decal(s)
- Decals are permanent and cannot be swapped or repositioned



Shown in black with decals on lid with front imprint

### IGLOO® Playmate Elite Cooler

Item #	Description	1	2-5	6-11	12-24
AC0161	Lid Decals	89.00	84.50	80.25	73.70
AC0162	Lid Decals with Front Imprint	102.00	98.35	95.75	93.75
AC0165	Lid Imprint	65.00	64.35	63.70	63.05

Setup fee: \$20(G)

Pricing is subject to change.

USD MSRP (C)

Product Size	Finished Graphic Size	Product Wt.	Media (Decal)
16"W x 15"H x 10"D	view online template	4.18 lbs.	hi tac decal vinyl film

#### Stock IGLOO® Playmate Elite Cooler Colors

- Crimson PMS 186
  - Azure PMS 286
  - Black
- PMS colors are for reference only and may vary slightly from actual color.*



Built-in handle for easy portability.



Holds up to 30 standard 12 oz. cans with ice.

## IGLOO® TAG ALONG TOO COOLER



This lightweight and hands-free cooler brings the fun to your next event without something extra to hold.

- 11 qt capacity
- MaxCold® insulation provides advanced ice retention
- Prevents leaks with interior gasket seal
- Shoulder strap for easy portability
- Constructed with durable plastic
- Available with full-color imprints

### IGLOO® Tag Along Too Cooler

Item #	Description	1	2-5	6-11	12-24
AC0171	Front and Lid Imprints	112.00	106.30	101.00	92.75

Setup fee: \$20(G)

Pricing is subject to change.

USD MSRP (C)

Product Size	Finished Graphic Size	Product Wt.
13"W x 13"H x 9"D	view online template	5.26 lbs.



Lock lid into place by turning the strap attachment upright.



Holds up to 14 standard 12 oz. cans with ice.



Imprint is prominent on the top of the lid.



Features a detent hinge that keeps lid open until it's closed.

**PRICES ARE SUBJECT TO CHANGE.** No setup fee on orders placed via our website. Visit [showdowndisplays.com](http://showdowndisplays.com) for current pricing, graphic templates, product videos and assembly instructions. See pages 288-291 for order details. SHOWDOWNDISPLAYS.COM · ASI 87188 · PPAI 254687 · SAGE 67383 · PPPC 20101202

production lead time after final proof approval  
**7 DAYS**



## IGLOO® KOOLTUNES COOLER



Turn up the fun with the ultimate party cooler that brings retro vibes and modern convenience.

- 14 qt capacity
- Boombox-style cooler with two built-in twin Bluetooth speakers provides up to 10 hours of playtime on a single charge; 3' USB charging cord included
- Features THERMECOOL™ insulated foam
- Constructed with durable plastic
- Available with full-color decals
- Decals are permanent and cannot be swapped or repositioned

### IGLOO® KoolTunes Cooler

Item #	Description	1	2-5	6-11	12-24
AC0141	Lid Decals	250.00	241.00	234.60	229.80

Setup fee: \$20(G)

Pricing is subject to change.

USD MSRP (C)

Product Size	Finished Graphic Size	Product Wt.	Media (Decal)
15"W x 14"H x 11"D	view online template	5.26 lbs.	hi tac decal vinyl film



Holds up to 26 standard 12 oz. cans with ice.



Control panel on back includes LED status indicator with charging port.



## IGLOO® 25QT RETRO PICNIC BASKET COOLER



A classic design with modern performance that can stay cool wherever you go!

- 25 qt capacity
- Features THERMECOOL™ insulated foam
- Waffle-top lid doubles as a seat
- Constructed with durable plastic
- Available with full-color imprint

### IGLOO® 25QT Retro Picnic Basket Cooler

Item #	Description	1	2-5	6-11	12-24
AC0091	Front Imprint	122.60	116.40	110.50	101.50

Setup fee: \$20(G)

Pricing is subject to change.

USD MSRP (C)

Product Size	Finished Graphic Size	Product Wt.
20"W x 13"H x 12"D	view online template	6 lbs.



Holds up to 36 standard 12 oz. cans with ice.



Two molded-in side handles for easy lifting.

#### Stock IGLOO® 25QT Retro Picnic Basket Cooler Colors

- Crimson PMS 186
- Azure PMS 286
- Black

PMS colors are for reference only and may vary slightly from actual color.

production lead time after final proof approval

**7 DAYS**

**PRICES ARE SUBJECT TO CHANGE.** No setup fee on orders placed via our website. Visit [showdowndisplays.com](http://showdowndisplays.com) for current pricing, graphic templates, product videos and assembly instructions. See pages 288-291 for order details.

SHOWDOWNDISPLAYS.COM · ASI 87188 · PPAI 254687 · SAGE 67383 · PPPC 20101202

## IGLOO® 28QT ROLLING COOLER



Pack up and roll out! All the durability and features of the 60 qt cooler in a smaller, more convenient size.

- 28 qt capacity
- Features two rugged wheels and a locking, telescoping handle
- Capped drainage hole
- Constructed with durable plastic
- Available with full-color decals
- Decals are permanent and cannot be swapped or repositioned



Holds up to 36 standard 12 oz. cans with ice.



Shown in crimson

### IGLOO® 28QT Rolling Cooler

Item #	Description	1	2-5	6-11	12-24
AC0101	Front, Side and Lid Decals	119.00	113.00	107.30	98.55

Setup fee: \$20(G)

Pricing is subject to change.

USD MSRP (C)

Product Size	Finished Graphic Size	Product Wt.	Media (Decal)
18"W x 17"H x 13"D	view online template	9 lbs.	hi tac decal vinyl film

#### Stock IGLOO® 28QT Rolling Cooler Colors

- White
- Azure PMS 286
- Crimson PMS 186

PMS colors are for reference only and may vary slightly from actual color.



Telescoping handle for quick and simple transportation.



Molded-in side handles for easy lifting.

## IGLOO® 60QT ROLLING COOLER



Big, bold and built to roll! This large signature cube-shaped cooler brings impressive capacity and effortless portability wherever you go.

- 60 qt capacity
- Features two rugged wheels and a locking, telescoping handle
- Capped drainage hole
- Constructed with durable plastic
- Available with full-color decals
- Decals are permanent and cannot be swapped or repositioned

Holds up to 94 standard 12 oz. cans with ice.



Shown in azure

### IGLOO® 60QT Rolling Cooler

Item #	Description	1	2-5	6-11	12-24
AC0131	Front, Side and Lid Decals	155.00	149.40	145.50	142.40

Setup fee: \$20(G)

Pricing is subject to change.

USD MSRP (C)

Product Size	Finished Graphic Size	Product Wt.	Media (Decal)
20"W x 22"H x 18"D	view online template	14 lbs.	hi tac decal vinyl film

#### Stock IGLOO® 60QT Rolling Cooler Colors

- White
- Azure PMS 286
- Crimson PMS 186

PMS colors are for reference only and may vary slightly from actual color.



Telescoping handle for quick and simple transportation.



Molded-in side handles for easy lifting.

Heavy-duty swing-up side handles for easy portability.



Holds up to 158 standard 12 oz. cans.



Cool Riser Technology® improves cooling performance by elevating away from hot surfaces.



Stainless steel bottle opener with catch bin for caps.

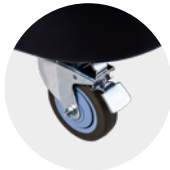

Two lockable swivel castor wheels.



Threaded drain plug for easy hose attachment.



Removable drink tray dividers and bottle caddy.

## IGLOO® PARTY BAR COOLER



Your ultimate celebration companion! This large capacity cooler keeps drinks cold longer and the good times rolling all day long.

- 125 qt capacity
- Ultratherm™ foam-insulated body for long-lasting ice retention
- Utility loops hold towels or trash bags
- Removable lid that transforms the cooler into an open-air beverage tub
- Available with full-color imprint
- Assembly required; tools needed for assembly (not included)

### IGLOO® Party Bar Cooler

Item #	Description	1	2-5	6-11	12-24
AC0151	Front Imprint	383.00	369.25	359.50	352.00

Setup fee: \$20(G)

Pricing is subject to change.

USD MSRP (C)

Product Size	Finished Graphic Size	Product Wt.
39.1"W x 26.9"H x 21.8"D	view online template	34.27 lbs.



Single pivot lid can be opened and closed with one hand.



Drain cooler easily with spout located at base.

## OUTDOOR EVENT COOLER



Keep drinks cold and your branding hot with this customizable cooler.

- Can be used indoors or outdoors
- Molded insulation keeps contents cold
- Clear lid lets you see what's inside
- Artwork is printed on Titan™ no-curl laminated media
- Holds up to 40 lbs. of ice and 48 standard 12 oz. cans

### Outdoor Event Cooler

Item #	Description	1	2-5	6-11	12-24
280240	Kit	515.00	505.00	499.75	489.25

Setup fee: \$20(G)

Pricing is subject to change.

Kit Includes: Cooler and Installed Graphic Wrap

USD MSRP (C)

Product Size	Finished Graphic Size	Product Wt.	Media
22.125"W x 35"H x 25.125"D	view online template	24.25 lbs.	Titan™ no-curl laminated media

PARTY BAR EVENT production lead time after final proof approval  
**7-OR-4 DAYS**



## IGLOO® 50QT MARINE PROFILE COOLER



This cooler is built for adventure with smart features, lasting chill and a design that's tough.

- 50 qt capacity
- Provides advanced ice retention
- Non-slip, comfort grip, swing-up handles
- Triple snap, leak-resistant drain plug
- Features THERMECOOL™ insulated foam
- Constructed with durable plastic that features UV inhibitors to protect against sun damage
- Available with full-color imprint and decals
- Decals are permanent and cannot be swapped or repositioned

### IGLOO® 50QT Marine Profile Cooler

Item #	Description	1	2-5	6-11	12-24
AC0111	Front, Side and Back Decals with Lid Imprint	155.00	153.50	151.90	150.40

Setup fee: \$20(G)

Pricing is subject to change.

USD MSRP (C)

Product Size	Finished Graphic Size	Product Wt.	Media (Decal)
23"W x 15"H x 14"D	view online template	9.5 lbs.	hi tac decal vinyl film



Holds up to 83 standard 12 oz. cans with ice.

## 65L ROLLING COOLER



This cooler is perfect for events, promotions, tailgates and outdoor gatherings.

- 65 liter capacity; holds up to 56 standard 12 oz. cans with ice
- Constructed with durable plastic
- Artwork is printed on Titan™ no-curl hybrid media

### 65L Rolling Cooler

Item #	Description	1	2-5	6-11	12-24
AC0071	Kit	346.50	343.00	339.50	336.00

Setup fee: \$20(G)

Pricing is subject to change.

Kit Includes: Cooler and Installed Graphic Wrap USD MSRP (C)

Product Size	Finished Graphic Size	Product Wt.	Media
16.5"W x 32"H x 16.5"D	view online template	15 lbs.	Titan™ no-curl hybrid media



**PRICES ARE SUBJECT TO CHANGE.** No setup fee on orders placed via our website. Visit [showdowndisplays.com](http://showdowndisplays.com) for current pricing, graphic templates, product videos and assembly instructions. See pages 288-291 for order details. SHOWDOWNDISPLAYS.COM · ASI 87188 · PPAI 254687 · SAGE 67383 · PPPC 20101202

production lead time after final proof approval  
**7 DAYS**



Shown with front and lid imprints

## 15L GRAB-N-GO COOLER



Designed for easy carry and all-day chill, it's your go-to for cool convenience on the move.

- 15 liter capacity
- Features long-lasting ice retention
- Constructed with durable plastic
- Available in a variety of full-color imprint(s), decal and/or wrap graphic
- Decals are permanent and cannot be swapped or repositioned
- Wrap graphic is not eligible for Rush Service

### 15L Grab-N-Go Cooler

Item #	Description	1	2-5	6-11	12-24
AC0011	Front Imprint	71.60	65.90	61.60	57.30
AC0012	Front and Lid Imprints	79.30	72.95	68.20	63.45
AC0013	Wrap Graphic	93.60	86.10	80.50	74.90
AC0014	Wrap Graphic with Lid Imprint	101.30	93.20	87.15	81.05
AC0017	Wrap Graphic with Lid Decal	108.60	99.90	93.40	86.90

Setup fee: \$20(G)

Pricing is subject to change.

USD MSRP (C)

Product Size	Finished Graphic Size	Product Wt.	Media (Wrap)
14"W x 13"H x 10.5"D	view online template	5 lbs.	wrap vinyl



Built-in handle for easy portability.



Holds up to 24 standard 12 oz. cans with ice.



Features two built-in cupholders on the lid.



## 25L OBP ROTOMOLDED COOLER



Engineered for any outing, this heavy-duty rotomolded cooler is virtually indestructible.

- 25 liter capacity; holds up to 32 standard 12 oz. cans with ice
- Constructed with ocean bound plastic (OBP); repurposing plastic waste before it reaches the ocean
- Available in a variety of full-color imprint, decal(s) and wrap graphic
- Decals are permanent and cannot be swapped or repositioned
- Wrap graphic is not eligible for Rush Service

### 25L OBP Rotomolded Cooler

Item #	Description	1	2-5	6-11	12-24
AC0031	Front Imprint	253.75	251.25	248.70	246.20
AC0032	Wrap Graphic with Lid Decal	297.75	294.75	291.75	288.75
AC0033	Wrap Graphic with Lid Decals	308.75	305.75	302.50	299.50

Setup fee: \$20(G)

Pricing is subject to change.

USD MSRP (C)

Product Size	Finished Graphic Size	Product Wt.	Media (Wrap / Decal)
18"W x 13.5"H x 12"D	view online template	16.5 lbs.	wrap vinyl / decal vinyl film



Quick-drain release valve.



Features a built-in handle and form-fitted interlock lid system.



Front imprint provides ample space for your logo or message.



Wrap graphic with lid decals includes an interior lid decal for additional branding.

production lead time after final proof approval

**7 DAYS**

## 35L OBP WHEELED EXPLORER COOLER



Make a quick getaway for any event with this perfectly sized cooler.

- 35 liter capacity; holds up to 42 standard 12 oz. cans with ice
- Durable wheels for easy portability
- Features form-fitted interlock lid system
- Constructed with ocean bound plastic (OBP); repurposing plastic waste before it reaches the ocean
- Available in a variety of full-color imprint, decal(s) and wrap graphic
- Decals are permanent and cannot be swapped or repositioned
- Wrap graphic is not eligible for Rush Service



Shown with wrap graphic with lid decal

### 35L OBP Wheeled Explorer Cooler

Item #	Description	1	2-5	6-11	12-24
AC0041	Front Imprint	390.50	386.50	382.50	378.75
AC0042	Wrap Graphic with Lid Decal	434.50	423.00	414.75	405.25
AC0043	Wrap Graphic with Lid Decals	445.50	433.75	425.00	415.50

Setup fee: \$20(G)

Pricing is subject to change.

USD MSRP (C)

Product Size	Finished Graphic Size	Product Wt.	Media (Wrap / Decal)
19.5"W x 19.5"H x 13.25"D	view online template	27 lbs.	wrap vinyl / decal vinyl film



Built-in telescoping handle.



Molded-in side handles for easy lifting.



Wrap graphic with lid decals includes an interior lid decal for additional branding.



Quick-drain release valve.

## 45L BENCH COOLER



A rugged, high-impact cooler that works hard and looks great doing it!

- 45 liter capacity
- Includes removable cushion
- Insulated rotomolded construction keeps contents cold
- Constructed with ocean bound plastic (OBP) and LLDPE
- Ocean bound plastic repurposes plastic waste before it reaches the ocean
- Features a capped drainage hole
- Available with full-color imprint(s)



Shown with front and cushion imprints

### 45L Bench Cooler

Item #	Description	1	2-5	6-11	12-24
AC0051	Front Imprint	436.50	432.25	427.75	423.50
AC0052	Front and Cushion Imprints	443.75	439.25	434.75	430.50

Setup fee: \$20(G)

Pricing is subject to change.

USD MSRP (C)

Product Size	Finished Graphic Size	Product Wt.
26"W x 16"H x 16"D	view online template	29 lbs.



Holds up to 60 standard 12 oz. cans with ice.

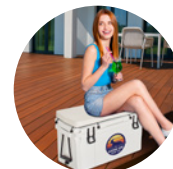

Thick, contoured cushion provides comfortable seating.

**PRICES ARE SUBJECT TO CHANGE.** No setup fee on orders placed via our website. Visit [showdowndisplays.com](http://showdowndisplays.com) for current pricing, graphic templates, product videos and assembly instructions. See pages 288-291 for order details. SHOWDOWNDISPLAYS.COM · ASI 87188 · PPAI 254687 · SAGE 67383 · PPPC 20101202

production lead time after final proof approval  
**7 DAYS**



Shown with wrap graphic with lid decal



Holds up to 36 standard 12 oz. cans with ice.



Rust-resistant lid latch and hardware.

# SASQUATCH™

Our Sasquatch™ Coolers aren't just built for the journey, they define it. With a sleek stainless steel exterior and generous capacity, they deliver lasting performance and standout style making them the ultimate companion for any journey.

## SASQUATCH™ 25L COOLER



Wherever your journey takes you, enjoy the durability and convenience of a compact, on-the-go design.

- 25 liter capacity
- Features a bottle opener
- Comfort grip steel handles
- Constructed with stainless steel
- Available with full-color imprint or wrap graphic with decal
- Decals are permanent and cannot be swapped or repositioned
- Wrap graphic is not eligible for Rush Service

### Sasquatch™ 25L Cooler

Item #	Description	1	2-5	6-11	12-24
AC0211	Front Imprint	228.70	226.40	224.10	221.80
AC0212	Wrap Graphic with Lid Decal	267.25	264.50	261.75	259.25

Setup fee: \$20(G)

Pricing is subject to change.

USD MSRP (C)

Product Size	Finished Graphic Size	Product Wt.	Media (Wrap / Decal)
18"W x 13"H x 11"D	view online template	14 lbs.	wrap vinyl / decal vinyl film

## SASQUATCH™ 54QT WOOD TOP COOLER



With thoughtful details built in and an optional engravable craft wood lid, it's made to chill and stand out anywhere you go.

- 54 qt capacity
- Tall design holds 2 liter bottles upright to help prevent spills
- Leak-resistant channel drain
- Constructed with stainless steel
- Available with full-color decal or wrap graphic with or without engraved lid
- Decals are permanent and cannot be swapped or repositioned
- Wrap graphic is not eligible for Rush Service

### Sasquatch™ 54QT Wood Top Cooler

Item #	Description	1	2-5	6-11	12-24
AC0241	Front Decal	402.00	391.50	383.75	375.00
AC0242	Wrap Graphic	446.00	434.25	425.75	416.00
AC0243	Wrap Graphic with Engraved Lid	485.50	473.00	463.50	453.00

Setup fee: \$20(G)

Pricing is subject to change.

USD MSRP (C)

Product Size	Finished Graphic Size	Product Wt.	Media (Wrap / Decal)
24"W x 17"H x 15"D	view online template	22 lbs.	wrap vinyl / decal vinyl film



Comfort grip steel handles.

Shown with wrap graphic with engraved lid



Built-in bottle opener.



Holds up to 85 standard 12 oz. cans with ice.



Craft wood lid with optional engraving.



Rust-resistant lid latch and hardware.

production lead time after final proof approval  
**7 DAYS**

**PRICES ARE SUBJECT TO CHANGE.** No setup fee on orders placed via our website.

Visit [showdowndisplays.com](http://showdowndisplays.com) for current pricing, graphic templates, product videos and assembly instructions. See pages 288-291 for order details.

SHOWDOWNDISPLAYS.COM · ASI 87188 · PPAI 254687 · SAGE 67383 · PPPC 20101202

## SASQUATCH™ 54QT COOLER



Our steel-belted cooler is made with the durability and capacity to keep up with any adventure.

- 54 qt capacity
- Tall design holds 2 liter bottles upright to help prevent spills
- Leak-resistant channel drain
- Constructed with steel
- Rust-resistant stainless steel lid latch and hardware
- Available in a variety of full-color imprint(s), decal(s) and wrap graphic
- Decals are permanent and cannot be swapped or repositioned
- Wrap graphic is not eligible for Rush Service



Shown in indigo with front imprint

Comfort grip steel handles.

### Sasquatch™ 54QT Cooler

Item #	Description	1	2-5	6-11	12-24
AC0221	Front Imprint	352.25	343.25	336.25	328.75
AC0222	Front and Lid Imprints	361.25	351.75	344.75	337.00
AC0223	Wrap Graphic with Lid Decal	396.25	386.00	378.25	369.75
AC0227	Wrap Graphic with Lid Decals	414.25	403.50	395.50	386.50

Setup fee: \$20(G)

Pricing is subject to change.

USD MSRP (C)

Product Size	Finished Graphic Size	Product Wt.	Media (Wrap / Decal)
22.5"W x 16.5"H x 14.5"D	view online template	23 lbs.	wrap vinyl / decal vinyl film

#### Stock Sasquatch™ 54QT Cooler Colors

- White
- Azure PMS 286
- Metallic Gray PMS 877
- Crimson PMS 186
- Indigo PMS 295
- Black

PMS colors are for reference only and may vary slightly from actual color.

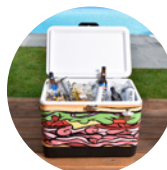

Holds up to 85 standard 12 oz. cans with ice.



Built-in bottle opener.

## SASQUATCH™ 54QT BLUETOOTH MUSIC COOLER



Take the party anywhere with this Bluetooth-enabled, LED-lit music cooler.

- 54 qt capacity
- Built-in bottle opener
- Tall design holds 2 liter bottles upright to help prevent spills
- Leak-resistant channel drain
- Constructed with stainless steel
- Available with full-color imprint(s) or wrap graphic
- Wrap graphic is not eligible for Rush Service



Shown with front and lid imprints

Comfort grip steel handles.

### Sasquatch™ 54QT Bluetooth Music Cooler

Item #	Description	1	2-5	6-11	12-24
AC0231	Front Imprint	420.50	416.25	412.00	407.75
AC0232	Front and Lid Imprints	429.50	425.25	421.00	416.75
AC0233	Wrap Graphic	475.50	470.75	466.00	461.25

Setup fee: \$20(G)

Pricing is subject to change.

USD MSRP (C)

Product Size	Finished Graphic Size	Product Wt.	Media (Wrap)
22.5"W x 16.5"H x 14.5"D	view online template	24 lbs.	wrap vinyl



Connect your smart device to the built-in Bluetooth speaker with solar-charging music activated LED lights.



Holds up to 85 standard 12 oz. cans with ice.



Rust-resistant lid latch and hardware.



Shown with wrap graphic with lid decals

## 54QT FULLY WRAPPED ROTOMOLDED COOLER



Our largest rotomolded cooler is built for durability and convenience. Perfect for any event!

- 54 qt capacity
- Constructed with ocean bound plastic (OBP) and LLDPE
- Ocean bound plastic repurposes plastic waste before it reaches the ocean
- Vibrant full-color decal and wrap graphic
- Available with full-color decal(s) and wrap graphic
- Decals are permanent and cannot be swapped or repositioned
- Not eligible for Rush Service

### 54QT Fully Wrapped Rotomolded Cooler

Item #	Description	1	2-5	6-11	12-24
AC0081	Wrap Graphic with Lid Decal	502.50	489.50	479.50	468.75
AC0082	Wrap Graphic with Lid Decals	524.50	511.00	500.50	489.25

Setup fee: \$20(G)

Pricing is subject to change.

USD MSRP (C)

Product Size	Finished Graphic Size	Product Wt.	Media (Wrap / Decal)
28.38"W x 16.49"H x 15.5"D	view online template	28 lbs.	wrap vinyl / decal vinyl film



Roped rubber handles for controlled lifting.



Holds up to 84 standard 12 oz. cans with ice.



Features form-fitted interlock lid system.



## PERSONAL COOLER BAG



From workdays to weekends this versatile cooler bag is the perfect size to keep your lunch or a 6-pack cool and convenient wherever you go.

- Features foam insulation and waterproof PEVA lining
- Includes adjustable shoulder strap for easy transport
- Secure shoulder strap with buckle
- Bag exterior is constructed with rPET polyester
- Available with full-color imprint

### Personal Cooler Bag

Item #	Description	1	2-5	6-11	12-24
AC0511	Front Imprint	26.59	26.32	26.06	25.79

Setup fee: \$20(G)

Pricing is subject to change.

USD MSRP (C)

Product Size	Finished Graphic Size	Product Wt.	Media
15.4"W x 9"H x 6.3"D	view online template	2.6 lbs.	rPET polyester



Holds up to 6 standard 12 oz. cans with ice.



Outside zipper pocket for accessible storage.



Easily carry with convenient shoulder strap.



Conveniently rolls up for compact storage.

production lead time after final proof approval

**7 DAYS**

**PRICES ARE SUBJECT TO CHANGE.** No setup fee on orders placed via our website. Visit [showdowndisplays.com](http://showdowndisplays.com) for current pricing, graphic templates, product videos and assembly instructions. See pages 288-291 for order details.

SHOWDOWNDISPLAYS.COM · ASI 87188 · PPAI 254687 · SAGE 67383 · PPPC 20101202

## IGLOO® BACKPACK COOLER



Keep your drinks and snacks perfectly chilled on-the-go with this easy-to-carry backpack cooler.

- Holds up to 18 standard 12 oz. cans with ice
- MaxCold® insulation provides advanced ice retention
- Bag exterior is constructed with rPET polyester
- Top handle for grab-and-go carrying
- Coated exterior bottom panel provides extra protection for longer lasting use
- Two side mesh pockets and a front zipper pocket for additional storage
- Adjustable, padded straps with breathable air mesh for added comfort
- Available with full-color imprint



Features a leak-resistant, antimicrobial liner that wipes clean easily.

### IGLOO® Backpack Cooler

Item #	Description	1	2-5	6-11	12-24
AC0521	Front Imprint	85.00	82.80	81.15	79.30

Setup fee: \$20(G) Pricing is subject to change.  
USD MSRP (C)

Product Size	Finished Graphic Size	Product Wt.	Media
11.25"W x 15"H x 9"D	view online template	1 lb.	rPET polyester

#### Stock IGLOO® Backpack Cooler Colors

- Turquoise PMS 2221
  - Charcoal PMS 425
- PMS colors are for reference only and may vary slightly from actual color.



Crush-proof EVA-molded lid compartment holds separate dry storage.



## BIG CHILL COOLER



Stay cool by combining temperature control with a soft, transport-friendly design making this the perfect cooler for trips, picnics or even daily errands.

- Holds up to 10 lbs. of ice and 24 standard 12 oz. cans
- Three-layer temperature control design features interior leak-proof liner with a layer of foam insulation
- Features two side clips for a more compact close
- Bag exterior is constructed with rPET polyester
- Available with full-color imprint



Shown in black

### Big Chill Cooler

Item #	Description	1	2-5	6-11	12-24
AC0501	Front Imprint	78.55	75.70	73.70	72.20

Setup fee: \$20(G) Pricing is subject to change.  
USD MSRP (C)

Product Size	Finished Graphic Size	Product Wt.	Media
17"W x 14"H x 9"D	view online template	4 lbs.	rPET polyester

#### Stock Big Chill Cooler Colors

- Crimson PMS 186
- Azure PMS 286
- Black

PMS colors are for reference only and may vary slightly from actual color.



Outside zipper pocket for accessible storage.



Includes handles and shoulder strap for easy transport.



## METAL TOOL BOX COOLER



Crafted with a sleek, high-gloss metal finish and inspired by vintage tool boxes, this industrial-style cooler combines timeless design with modern performance.

- 20 liter capacity
- Exterior is constructed with hi-gloss industrial metal
- Rust-resistant steel latch and handles
- Available with full-color imprint(s)

### Metal Tool Box Cooler

Item #	Description	1	2-5	6-11	12-24
AC0191	Front Imprint	195.30	193.30	191.30	189.40
AC0192	Front and Lid Imprints	211.80	209.60	207.50	205.40

Setup fee: \$20(G)

Pricing is subject to change.

USD MSRP (C)

Product Size	Finished Graphic Size	Product Wt.
17.5"W x 12"H x 10"D	view online template	12 lbs.



Holds up to 24 standard 12 oz. cans with ice.



Built-in bottle opener.

### Stock Metal Tool Box Cooler Colors

- White
- Azure PMS 286
- Crimson PMS 186
- Black

*PMS colors are for reference only and may vary slightly from actual color.*



Shown in indigo with front imprint

## METAL PARTY COOLER



Keep your drinks cold and your style hot with this vintage inspired cooler.

- 15 liter capacity
- Features long-lasting ice retention
- Exterior is constructed with hi-gloss industrial metal
- Built-in bottle opener
- Available with full-color imprint(s)

### Metal Party Cooler

Item #	Description	1	2-5	6-11	12-24
AC0181	Front Imprint	113.20	112.10	110.90	109.80
AC0182	Front and Lid Imprints	126.40	125.10	123.90	122.60

Setup fee: \$20(G)

Pricing is subject to change.

USD MSRP (C)

Product Size	Finished Graphic Size	Product Wt.
12"W x 12.25"H x 10.5"D	view online template	13 lbs.



Holds up to 24 standard 12 oz. cans with ice.



Built-in bottle opener.

### Stock Metal Party Cooler Colors

- White
- Azure PMS 286
- Black
- Crimson PMS 186
- Indigo PMS 295

*PMS colors are for reference only and may vary slightly from actual color.*

production lead time after final proof approval

**7 DAYS**

**PRICES ARE SUBJECT TO CHANGE.** No setup fee on orders placed via our website.

Visit [showdowndisplays.com](http://showdowndisplays.com) for current pricing, graphic templates, product videos and assembly instructions. See pages 288-291 for order details.

SHOWDOWNDISPLAYS.COM · ASI 87188 · PPAI 254687 · SAGE 67383 · PPPC 20101202

## WOOD TOP COOLER



Vintage tool box style with modern functionality that is durable, eye-catching and built to entertain.

- 20 liter capacity
- Features craft wood lid that doubles as a serving tray
- Constructed with high-gloss steel including rust-resistant handles
- Available with full-color imprint



### Wood Top Cooler

Item #	Description	1	2-5	6-11	12-24
AC0251	Front Imprint	223.00	220.70	218.50	216.30

Setup fee: \$20(G) Pricing is subject to change.  
USD MSRP (C)

Product Size	Finished Graphic Size	Product Wt.
18.3"W x 11.6"H x 9.9"D	view online template	12 lbs.



Holds up to 24 standard 12 oz. cans with ice.



Lid features two built-in cupholders.

## VINTAGE COOLER



Experience a blend of nostalgia and innovation with this cooler that combines modern cooling technology with the timeless charm of the past.

- 17 liter capacity
- Exterior is constructed with hi-gloss industrial metal and aluminum accents
- Temperature control technology
- Available with full-color imprint or wrap graphic
- Wrap graphic is not eligible for Rush Service



Shown in crimson with wrap graphic

### Vintage Cooler

Item #	Description	1	2-5	6-11	12-24
AC0001	Front Imprint	130.60	129.30	128.00	126.70
AC0002	Wrap Graphic	166.90	165.20	163.50	161.90

Setup fee: \$20(G) Pricing is subject to change.  
USD MSRP (C)

Product Size	Finished Graphic Size	Product Wt.	Media (Wrap)
12.5"W x 15.5"H x 9.5"D	view online template	12 lbs.	wrap vinyl



Built-in bottle opener.



Holds up to 16 standard 12 oz. cans with ice.

#### Stock Vintage Cooler Colors

- White
- Lapis PMS 2945
- Black
- Crimson PMS 186
- Indigo PMS 295

PMS colors are for reference only and may vary slightly from actual color.

PRICES ARE SUBJECT TO CHANGE. No setup fee on orders placed via our website. Visit [showdowndisplays.com](http://showdowndisplays.com) for current pricing, graphic templates, product videos and assembly instructions. See pages 288-291 for order details. SHOWDOWNDISPLAYS.COM · ASI 87188 · PPAI 254687 · SAGE 67383 · PPPC 20101202

production lead time after final proof approval  
**7 DAYS**



When open, the top creates a small table.

Shown with front and top imprints

## 15L MINI COOL BAR



Bring the party wherever you go by combining a cooler and pop-up table in one stylish, space-saving design.

- 15 liter capacity; holds up to 15 standard 12 oz. cans with ice
- Built-in handle
- Constructed with durable plastic
- Available with full-color imprint(s) or wrap graphic with decal
- Decals are permanent and cannot be swapped or repositioned
- Wrap graphic is not eligible for Rush Service

### 15L Mini Cool Bar

Item #	Description	1	2-5	6-11	12-24
AC0021	Front Imprint	166.10	160.10	155.90	152.60
AC0022	Front and Top Imprints	177.10	170.70	166.20	162.80
AC0023	Wrap Graphic with Top Decal	193.60	186.60	181.70	177.90

Setup fee: \$20(G)

Pricing is subject to change.

USD MSRP (C)

Product Size	Finished Graphic Size	Product Wt.	Media (Wrap / Decal)
13.5"W x 14.75"-23"H x 13.5"D	view online template	7 lbs.	wrap vinyl / decal vinyl film



Built-in bottle opener.



Features a condiment caddy with clear tongs.



Telescoping pole with locking system holds the tabletop in place when fully extended.



## 45L COOL BAR



The ultimate combination of cooler and stylish bar table, perfect for parties, patios and corporate events.

- 45 liter capacity
- Double-walled, condensation-free design keeps drinks cold and surfaces dry
- Built-in drainage hole with stopper
- Can be used with or without optional legs
- Available with wrap graphic with decal
- Decals are permanent and cannot be swapped or repositioned
- Assembly required
- Not eligible for Rush Service

### 45L Cool Bar

Item #	Description	1	2-5	6-11	12-24
AC0061	Wrap Graphic with Top Decal	249.50	247.00	244.50	242.00

Setup fee: \$20(G)

Pricing is subject to change.

USD MSRP (C)

Product Size	Finished Graphic Size	Product Wt.	Media (Wrap / Decal)
19.5"W x 22"-34"H x 19.5"D	view online template	14 lbs.	wrap vinyl / decal vinyl film



Constructed with durable plastic.



Telescoping pole with locking system holds the tabletop in place when fully extended.



Holds up to 40 standard 12 oz. cans with ice.

production lead time after final proof approval

**7 DAYS**

**PRICES ARE SUBJECT TO CHANGE.** No setup fee on orders placed via our website. Visit [showdowndisplays.com](http://showdowndisplays.com) for current pricing, graphic templates, product videos and assembly instructions. See pages 288-291 for order details.

SHOWDOWNDISPLAYS.COM · ASI 87188 · PPAI 254687 · SAGE 67383 · PPPC 20101202

## RAISE THE BAR COOLER



Take your entertaining to the next level with a cooler that instantly transforms into a fully functional bar.

- 63 qt capacity
- Includes lower storage shelf
- Two swivel locking wheels
- Features a capped drainage hole
- Constructed with steel
- Available with full-color imprint(s) or wrap graphic with decal
- Decals are permanent and cannot be swapped or repositioned
- Assembly required; tool included
- Wrap graphic is not eligible for Rush Service

### Raise the Bar Cooler

Item #	Description	1	2-5	6-11	12-24
AC0201	Front Imprint	421.75	410.75	402.50	393.50
AC0202	Front and Top Imprints	430.75	419.50	411.25	402.00
AC0203	Wrap Graphic with Top Decal	472.25	460.00	450.75	440.50

Setup fee: \$20(G)

Pricing is subject to change.

USD MSRP (C)

Product Size	Finished Graphic Size	Product Wt.	Media (Wrap / Decal)
27.5"W x 32"H x 14.5"D	view online template	30.86 lbs.	wrap vinyl / decal vinyl film

Elevating top that extends up to 8".



Shown with front and top imprints



Holds up to 120 standard 12 oz. cans with ice.



Built-in bottle opener and cap catcher.

## ROLLING COOLER VENDING CART



Keep drinks cold and business rolling with this ready to serve cooler!

- 80 qt capacity
- Features a capped drainage hole
- Includes brackets to hold a market umbrella for shade (sold separately)
- Steel construction with a high insulation, solid plastic lining
- Available with full-color imprint or wrap graphic with or without decals
- Decals are permanent and cannot be swapped or repositioned
- Assembly required
- Wrap graphic is not eligible for Rush Service

### Rolling Cooler Vending Cart

Item #	Description	1	2-5	6-11	12-24
AC0261	Front Imprint	392.75	388.75	384.75	381.00
AC0262	Wrap Graphic	436.75	432.25	428.00	423.50
AC0263	Wrap Graphic with Lid Decals	474.00	469.25	464.50	460.00

Setup fee: \$20(G)

Pricing is subject to change.

USD MSRP (C)

Product Size	Finished Graphic Size	Product Wt.	Media (Wrap / Decal)
31"W x 33"H x 15"D	view online template	46 lbs.	wrap vinyl / decal vinyl film

Two swivel locking wheels.



Shown with wrap graphic and lid decals



Holds up to 80 standard 12 oz. cans with ice.



Built-in bottle opener and cap catcher.

**PRICES ARE SUBJECT TO CHANGE.** No setup fee on orders placed via our website. Visit [showdowndisplays.com](http://showdowndisplays.com) for current pricing, graphic templates, product videos and assembly instructions. See pages 288-291 for order details. SHOWDOWNDISPLAYS.COM · ASI 87188 · PPAI 254687 · SAGE 67383 · PPPC 20101202

production lead time after final proof approval  
**7 DAYS**



# BAGS

1. Rivet Tote page 207 2. MVP Duffel page 210 3. On-the-Go Backpack page 212 4. Rock the Boat Bag page 203  
5. Hampton Tote page 208 6. On-the-Go Belt Bag page 211

## have you considered...

- **purpose** will the bag be used primarily for daily use, travel, or work, sport and other events?
- **audience** who will be using the bag?
- **size** how much do you need your bag to hold?
- **longevity** do you plan to have the bag used long-term or for a short-time promotion?
- **comfort** do you need padded straps or multiple handles?

## SATCHELS™ NEW YORK

Exclusively at Showdown Displays, our curated bag collection ranges from totes, to boat bags and backpacks. You'll be able to find just about any bag for your campaign such as giveaways and client appreciations.

# EMBROIDERED BAGS

## ELEVATE AND SET YOUR BRAND APART

Make a lasting impression with custom embroidered bags! Your logo is expertly stitched for a polished, professional look that stands the test of time. Embroidery adds rich texture and dimension to your artwork, creating a high-end finish that elevates any design.

### Embroidery Art Specifications

- Available for select bags; see product page for details
- Includes up to 8,000 stitches and up to six thread colors
- Custom options available (call for quote; restrictions may apply)
- Vector artwork required (PMS colors are required)
- Embroidery Tape Fee is included in the setup costs: \$110.00(G) per art setup per order
- Not eligible for Rush Service



Create a unique branded experience with embroidered artwork.



YOUR BAG YOUR WAY

### CUSTOM BRANDED BAGS

Select bags allow for customization options. Additional charges apply. See website for details, MOQ and lead times.

Custom bag options include: body color, printed or solid-color bag lining, woven ribbon, adjustable shoulder straps, leather handles, and more! Not all options are available for all bags.

### ROCK THE BOAT™ BAG



Built tough and ready to carry your brand wherever it goes.

- Constructed of 15 oz. natural cotton canvas with zipper closure
- Available with vibrant full-color imprint or embroidery
- Minimum order quantity of six for full-color imprint; 12 for embroidery
- Embroidery is not eligible for Rush Service

#### Full-Color Front Imprint

Item #	Description	6-11	12-24	25-49	50-149
AB0041	Rock the Boat™ Bag	18.77	17.63	16.63	15.52

Setup fee: \$20(G)

Pricing is subject to change.

Stock fabric colors with full-color artwork. Minimum order quantity of 6.

USD MSRP (C)

#### Embroidered

Item #	Description	12-24	25-49	50-74	75-99
ABE041	Rock the Boat™ Bag	25.62	24.47	23.44	22.42

Setup (includes embroidery tape) fee: \$110(G)

Pricing is subject to change.

Stock fabric colors with embroidery (max 6 thread colors). Minimum order quantity of 12.

USD MSRP (C)

Product Size	Handle Drop	Finished Graphic Size	Product Wt. (Qty 6 / 12)	Media
20"W x 12"H x 7.5"D	9"	view online template	7.5 lbs. / 15 lbs.	15 oz. cotton canvas

Handles and trim are color-matched for a cohesive look.

Expandable zipper top.



Shown in natural/maroon with full-color imprint

#### Stock Rock the Boat™ Bag Colors

- Azure PMS 286
- Indigo PMS 295
- Black
- Natural PMS 9060 / Pumpkin PMS 165
- Natural PMS 9060 / Crimson PMS 186
- Natural PMS 9060 / Ruby PMS 201
- Natural PMS 9060 / Maroon PMS 202
- Natural PMS 9060 / Azure PMS 286
- Natural PMS 9060 / Indigo PMS 295
- Natural PMS 9060 / Spruce PMS 3435
- Natural PMS 9060 / Black

PMS colors are for reference only and may vary slightly from actual color.



Includes a front exterior pocket.

**PRICES ARE SUBJECT TO CHANGE.** No setup fee on orders placed via our website (excludes embroidery). Visit [showdowndisplays.com](http://showdowndisplays.com) for current pricing, graphic templates, product videos and assembly instructions. See pages 288-291 for order details. SHOWDOWNDISPLAYS.COM · ASI 87188 · PPAI 254687 · SAGE 67383 · PPPC 20101202

IMPRINT EMBROIDERY production lead time after final proof approval  
**5-OR-10 DAYS**



Expandable zipper top.

Shown in natural/spruce with full-color imprint



Includes a front exterior pocket.

## CLASSIC BOAT BAG



Timeless style meets rugged durability that can carry it all!

- Constructed of 18 oz. natural cotton canvas
- Handles and trim are color-matched for a cohesive look
- Available with vibrant full-color imprint or embroidery
- Minimum order quantity of six for full-color imprint; 12 for embroidery
- Embroidery is not eligible for Rush Service

### Full-Color Front Imprint

Item #	Description	6-11	12-24	25-49	50-149
AB0001	Classic Boat Bag	22.03	20.69	19.52	18.22

Setup fee: **\$20(G)**

Pricing is subject to change.

Stock fabric colors with full-color artwork.  
Minimum order quantity of 6.

USD MSRP (C)

### Embroidered

Item #	Description	12-24	25-49	50-74	75-99
ABE001	Classic Boat Bag	28.88	27.58	26.43	25.27

Setup (includes embroidery tape) fee: **\$110(G)**

Pricing is subject to change.

Stock fabric colors with embroidery (max 6 thread colors).  
Minimum order quantity of 12.

USD MSRP (C)

Product Size	Handle Drop	Finished Graphic Size	Product Wt. (Qty 6 / 12)	Media
20"W x 12"H x 7.5"D	9"	view online template	8.4 lbs. / 16.8 lbs.	18 oz. canvas

### Stock Classic Boat Bag Colors

- Natural PMS 9060 / Pumpkin PMS 165
- Natural PMS 9060 / Crimson PMS 186
- Natural PMS 9060 / Azure PMS 286
- Natural PMS 9060 / Indigo PMS 295
- Natural PMS 9060 / Spruce PMS 3435
- Natural PMS 9060 / Black

PMS colors are for reference only and may vary slightly from actual color.



14 oz. canvas handles and trim are color-matched for a cohesive look.

Shown in natural/ruby with full-color imprint



Features a front exterior pocket.



Open top design for quick access.

## OPEN CANVAS BOAT BAG



Crafted for everyday utility with timeless style.

- Constructed of 14 oz. natural cotton canvas with shoulder length handles
- Available with vibrant full-color imprint or embroidery
- Minimum order quantity of six for full-color imprint; 12 for embroidery
- Embroidery is not eligible for Rush Service

### Full-Color Front Imprint

Item #	Description	6-11	12-24	25-49	50-149
AB0011	Open Canvas Boat Bag	15.73	14.77	13.94	13.01

Setup fee: **\$20(G)**

Pricing is subject to change.

Stock fabric colors with full-color artwork.  
Minimum order quantity of 6.

USD MSRP (C)

### Embroidered

Item #	Description	12-24	25-49	50-74	75-99
ABE011	Open Canvas Boat Bag	22.58	21.56	20.66	19.76

Setup (includes embroidery tape) fee: **\$110(G)**

Pricing is subject to change.

Stock fabric colors with embroidery (max 6 thread colors).  
Minimum order quantity of 12.

USD MSRP (C)

Product Size	Handle Drop	Finished Graphic Size	Product Wt. (Qty 6 / 12)	Media
20"W x 12"H x 7.5"D	9.5"	view online template	6.3 lbs. / 12.6 lbs.	14 oz. canvas

### Stock Open Canvas Boat Bag Colors

- Natural PMS 9060 / Crimson PMS 186
- Natural PMS 9060 / Ruby PMS 201
- Natural PMS 9060 / Azure PMS 286
- Natural PMS 9060 / Indigo PMS 295
- Natural PMS 9060 / Spruce PMS 3435
- Natural PMS 9060 / Black

PMS colors are for reference only and may vary slightly from actual color.

IMPRINT EMBROIDERY production lead time after final proof approval  
**5-OR-10 DAYS**

**PRICES ARE SUBJECT TO CHANGE.** No setup fee on orders placed via our website (excludes embroidery). Visit [showdowndisplays.com](http://showdowndisplays.com) for current pricing, graphic templates, product videos and assembly instructions. See pages 288-291 for order details.

SHOWDOWNDISPLAYS.COM · ASI 87188 · PPAI 254687 · SAGE 67383 · PPPC 20101202

## CARRY-ALL TOTE



Never worry about running out of room again! Wherever you go, this tote has you covered.

- Constructed of 15 oz. natural cotton canvas
- Features a secure magnetic closure
- Collar, shoulder length handles and trim are color-matched
- Available with vibrant full-color imprint or embroidery
- Minimum order quantity of six for full-color imprint; 12 for embroidery
- Embroidery is not eligible for Rush Service



Color-matched tote components create a cohesive look.



Includes an inside zipper pocket.



Shown in natural/pumpkin with embroidery

### Full-Color Front Imprint

Item #	Description	6-11	12-24	25-49	50-149
AB0061	Carry-All Tote	19.42	18.24	17.21	16.06

Setup fee: \$20(G)

Pricing is subject to change.

Stock fabric colors with full-color artwork.  
Minimum order quantity of 6.

USD MSRP (C)

### Embroidered

Item #	Description	12-24	25-49	50-74	75-99
ABE061	Carry-All Tote	26.27	25.09	24.04	22.99

Setup (includes embroidery tape) fee: \$110(G)

Pricing is subject to change.

Stock fabric colors with embroidery (max 6 thread colors).  
Minimum order quantity of 12.

USD MSRP (C)

Product Size	Handle Drop	Finished Graphic Size	Product Wt. (Qty 6 / 12)	Media
15.5"W x 15.5"H x 4.25"D	10.25"	view online template	6 lbs. / 12 lbs.	15 oz. canvas

#### Stock Carry-All Tote Colors

- Natural PMS 9060 / Pumpkin PMS 165
- Natural PMS 9060 / Crimson PMS 186
- Natural PMS 9060 / Indigo PMS 295
- Natural PMS 9060 / Black

PMS colors are for reference only and may vary slightly from actual color.

## ON-THE-GO TOTE



This sleek, minimalist all-black tote offers ample space to accommodate all your essentials.

- Constructed of rPET polyester
- Zippered main compartment
- Fully lined interior
- Sturdy, adjustable handles for easy travel
- Available with vibrant full-color imprint or embroidery
- Minimum order quantity of six for full-color imprint; 12 for embroidery
- Embroidery is not eligible for Rush Service

### Full-Color Front Imprint

Item #	Description	6-11	12-24	25-49	50-149
AB0091	On-the-Go Tote	54.15	50.85	47.97	44.77

Setup fee: \$20(G)

Pricing is subject to change.

Black with full-color artwork.  
Minimum order quantity of 6.

USD MSRP (C)

### Embroidered

Item #	Description	12-24	25-49	50-74	75-99
ABE091	On-the-Go Tote	61.00	58.25	55.80	53.35

Setup (includes embroidery tape) fee: \$110(G)

Pricing is subject to change.

Black with embroidery (max 6 thread colors).  
Minimum order quantity of 12.

USD MSRP (C)

Product Size	Handle Drop	Finished Graphic Size	Product Wt. (Qty 6 / 12)	Media
21"W x 13"H x 6"D	10.5"	view online template	6 lbs. / 12 lbs.	rPET polyester



Features interior mesh pockets.

PRICES ARE SUBJECT TO CHANGE. No setup fee on orders placed via our website (excludes embroidery). Visit [showdowndisplays.com](http://showdowndisplays.com) for current pricing, graphic templates, product videos and assembly instructions. See pages 288-291 for order details.

SHOWDOWNDISPLAYS.COM · ASI 87188 · PPAI 254687 · SAGE 67383 · PPPC 20101202

IMPRINT EMBROIDERY production lead time after final proof approval  
**5-10 DAYS**



## JAMIE TOTE



Add personality and practicality to your look with this boho fashion tote that brings a touch of carefree charm.

- Constructed of 24 oz. natural cotton canvas
- Features fringe accents
- Interior zippered pocket
- Thick handles for easy travel
- Available with vibrant full-color imprint or embroidery
- Minimum order quantity of six for full-color imprint; 12 for embroidery
- Embroidery is not eligible for Rush Service

### Full-Color Front Imprint

Item #	Description	6-11	12-24	25-49	50-149
AB0081	Jamie Tote	33.75	32.40	31.39	30.38

**Setup fee: \$20(G)**

**Pricing is subject to change.**

Natural with full-color artwork.  
Minimum order quantity of 6.

USD MSRP (C)

### Embroidered

Item #	Description	12-24	25-49	50-74	75-99
ABE081	Jamie Tote	40.74	38.91	37.28	35.65

**Setup (includes embroidery tape) fee: \$110(G)**

**Pricing is subject to change.**

Natural with embroidery (max 6 thread colors).  
Minimum order quantity of 12.

USD MSRP (C)

Product Size	Handle Drop	Finished Graphic Size	Product Wt. (Qty 6 / 12)	Media
14"W x 13.5"H x 6"D	7"	view online template	10.8 lbs. / 21.6 lbs.	24 oz. canvas



Fit the essentials for daily use in your tote.

Bold stripes contrast with the natural canvas for added appeal.



Includes an inside zipper pocket.



Shown in natural/azure with full-color imprint

## STRIPED CANVAS TOTE



Get noticed with this stylish tote. Perfect for daily use, events or on-the-go adventure.

- Constructed of 15 oz. natural cotton canvas with cotton handles
- Available with vibrant full-color imprint or embroidery
- Minimum order quantity of six for full-color imprint; 12 for embroidery
- Embroidery is not eligible for Rush Service

### Full-Color Front Imprint

Item #	Description	6-11	12-24	25-49	50-149
AB0111	Striped Canvas Tote	19.42	18.24	17.21	16.06

**Setup fee: \$20(G)**

**Pricing is subject to change.**

Stock fabric colors with full-color artwork.  
Minimum order quantity of 6.

USD MSRP (C)

### Embroidered

Item #	Description	12-24	25-49	50-74	75-99
ABE111	Striped Canvas Tote	26.27	25.09	24.04	22.99

**Setup (includes embroidery tape) fee: \$110(G)**

**Pricing is subject to change.**

Stock fabric colors with embroidery (max 6 thread colors).  
Minimum order quantity of 12.

USD MSRP (C)

Product Size	Handle Drop	Finished Graphic Size	Product Wt. (Qty 6 / 12)	Media
18"W x 16"H x 4"D	9"	view online template	7.5 lbs. / 15 lbs.	15 oz. canvas

#### Stock Striped Canvas Tote Colors

- Natural PMS 9060 / Pumpkin PMS 165
- Natural PMS 9060 / Crimson PMS 186
- Natural PMS 9060 / Azure PMS 286
- Natural PMS 9060 / Indigo PMS 295
- Natural PMS 9060 / Black

PMS colors are for reference only and may vary slightly from actual color.

IMPRINT EMBROIDERY production lead time after final proof approval  
**5-OR-10 DAYS**

**PRICES ARE SUBJECT TO CHANGE.** No setup fee on orders placed via our website (excludes embroidery). Visit [showdowndisplays.com](http://showdowndisplays.com) for current pricing, graphic templates, product videos and assembly instructions. See pages 288-291 for order details.

SHOWDOWNDISPLAYS.COM · ASI 87188 · PPAI 254687 · SAGE 67383 · PPPC 20101202

## ROPE TOTE



Rugged yet refined. This tote is your go-to for casual luxe with a coastal vibe.

- Constructed of 16 oz. natural cotton canvas
- Available with vibrant full-color imprint or embroidery
- Minimum order quantity of six for full-color imprint; 12 for embroidery
- Embroidery is not eligible for Rush Service

### Full-Color Front Imprint

Item #	Description	6-11	12-24	25-49	50-149
AB0191	Rope Tote	23.98	23.02	22.30	21.58

**Setup fee: \$20(G)** **Pricing is subject to change.**  
 Stock fabric colors with full-color artwork. USD MSRP (C)  
 Minimum order quantity of 6.

### Embroidered

Item #	Description	12-24	25-49	50-74	75-99
ABE191	Rope Tote	30.83	29.44	28.21	26.98

**Setup (includes embroidery tape) fee: \$110(G)** **Pricing is subject to change.**  
 Stock fabric colors with embroidery (max 6 thread colors). USD MSRP (C)  
 Minimum order quantity of 12.

Product Size	Handle Drop	Finished Graphic Size	Product Wt. (Qty 6 / 12)	Media
14"W x 12"H x 8"D	10.5"	view online template	8.4 lbs. / 16.8 lbs.	16 oz. recycled cotton canvas



Features grommets with natural rope handles and accent piping.

Spacious interior.

Shown in natural/black with full-color imprint

#### Stock Rope Tote Colors

- Natural PMS 9060 / Black
  - Natural PMS 9060 / Indigo PMS 295
- PMS colors are for reference only and may vary slightly from actual color.*

## RIVET TOTE



A rugged yet irresistibly soft tote whether you're heading to the market, the office or a weekend getaway.

- Constructed of 18 oz. cotton canvas
- Available with vibrant full-color imprint or embroidery
- Minimum order quantity of six for full-color imprint; 12 for embroidery
- Embroidery is not eligible for Rush Service

### Full-Color Front Imprint

Item #	Description	6-11	12-24	25-49	50-149
AB0101	Rivet Tote	22.79	21.88	21.19	20.51

**Setup fee: \$20(G)** **Pricing is subject to change.**  
 Stock fabric colors with full-color artwork. USD MSRP (C)  
 Minimum order quantity of 6.

### Embroidered

Item #	Description	12-24	25-49	50-74	75-99
ABE101	Rivet Tote	29.64	28.31	27.12	25.94

**Setup (includes embroidery tape) fee: \$110(G)** **Pricing is subject to change.**  
 Stock fabric colors with embroidery (max 6 thread colors). USD MSRP (C)  
 Minimum order quantity of 12.

Product Size	Handle Drop	Finished Graphic Size	Product Wt. (Qty 6 / 12)	Media
25"W x 12.5"H x 4"D	10.75"	view online template	8.4 lbs. / 16.8 lbs.	18 oz. cotton canvas



Large front pocket.

Shoulder length handles for easy travel.

Shown in pumpkin with embroidery

#### Stock Rivet Tote Colors

- Pumpkin PMS 165
- Crimson PMS 186
- Indigo PMS 295
- Black

*PMS colors are for reference only and may vary slightly from actual color.*



Features snap closure and matching copper rivets.

**PRICES ARE SUBJECT TO CHANGE.** No setup fee on orders placed via our website (excludes embroidery). Visit [showdowndisplays.com](http://showdowndisplays.com) for current pricing, graphic templates, product videos and assembly instructions. See pages 288-291 for order details. SHOWDOWNDISPLAYS.COM · ASI 87188 · PPAI 254687 · SAGE 67383 · PPPC 20101202

IMPRINT      EMBROIDERY      production lead time after final proof approval  
**5-OR-10 DAYS**



Features chrome snap closures at top and sides.



Shown in white/indigo with full-color imprint



Handles, trim and striped cotton lining are color-matched for a cohesive look.

## HAMPTON TOTE



This tote combines chic design and practical space for every adventure.

- Constructed of 18 oz. white cotton canvas with interior zippered pocket
- Available with vibrant full-color imprint or embroidery
- Minimum order quantity of six for full-color imprint; 12 for embroidery
- Embroidery is not eligible for Rush Service

### Full-Color Front Imprint

Item #	Description	6-11	12-24	25-49	50-149
AB0071	Hampton Tote	40.73	39.10	37.88	36.66

Setup fee: \$20(G)

Pricing is subject to change.

Stock fabric colors with full-color artwork. Minimum order quantity of 6.

USD MSRP (C)

### Embroidered

Item #	Description	12-24	25-49	50-74	75-99
ABE071	Hampton Tote	47.72	45.57	43.66	41.76

Setup (includes embroidery tape) fee: \$110(G)

Pricing is subject to change.

Stock fabric colors with embroidery (max 6 thread colors). Minimum order quantity of 12.

USD MSRP (C)

Product Size	Handle Drop	Finished Graphic Size	Product Wt. (Qty 6 / 12)	Media
17"W x 13"H x 8"D	7.75"	view online template	8 lbs. / 16 lbs.	18 oz. canvas

#### Stock Hampton Tote Colors

- White / Black
- White / Indigo PMS 295

PMS colors are for reference only and may vary slightly from actual color.



Features neutral gray lining.



Shown in indigo with embroidery



Includes a large outside pocket, inside zippered pocket and secure keyring.



## BARON TOTE



From work to weekend, this eco-conscious tote is designed to fit your busy lifestyle.

- Constructed of rPET Polyester
- Available with vibrant full-color imprint or embroidery
- Minimum order quantity of six for full-color imprint; 12 for embroidery
- Embroidery is not eligible for Rush Service

### Full-Color Front Imprint

Item #	Description	6-11	12-24	25-49	50-149
AB0051	Baron Tote	39.93	37.49	35.38	33.02

Setup fee: \$20(G)

Pricing is subject to change.

Stock fabric colors with full-color artwork. Minimum order quantity of 6.

USD MSRP (C)

### Embroidered

Item #	Description	12-24	25-49	50-74	75-99
ABE051	Baron Tote	46.78	44.67	42.80	40.93

Setup (includes embroidery tape) fee: \$110(G)

Pricing is subject to change.

Stock fabric colors with embroidery (max 6 thread colors). Minimum order quantity of 12.

USD MSRP (C)

Product Size	Handle Drop	Finished Graphic Size	Product Wt. (Qty 6 / 12)	Media
14"W x 11"H x 5.5"D	8.5"	view online template	5.2 lbs. / 10.4 lbs.	rPET polyester

#### Stock Baron Tote Colors

- Indigo PMS 295
- Gray Camo
- Black

PMS colors are for reference only and may vary slightly from actual color.

IMPRINT EMBROIDERY production lead time after final proof approval  
**5-OR-10 DAYS**

**PRICES ARE SUBJECT TO CHANGE.** No setup fee on orders placed via our website (excludes embroidery). Visit [showdowndisplays.com](http://showdowndisplays.com) for current pricing, graphic templates, product videos and assembly instructions. See pages 288-291 for order details.

SHOWDOWNDISPLAYS.COM · ASI 87188 · PPAI 254687 · SAGE 67383 · PPPC 20101202

## FLEX TOTE



This durable, beach-ready tote delivers style with the added benefit of custom branding.

- Constructed of strong, lightweight EVA plastic
- Large capacity fits up to six full-size towels; holds up to 40 lbs.
- Tote is 0.125" thick; handles are 0.25" thick
- Non-collapsible and tip-proof
- Easily wipes clean
- Holes on front and back of bag; holes have a 9/16" dia.
- Vivid full-color imprint
- Minimum order quantity of six



Shown in rose with center imprint

### Flex Tote

Item #	Description	6-11	12-24	25-49	50-149
AB0201	Center Imprint	60.00	56.35	53.15	49.62
AB0202	Lower Imprint	45.00	42.26	39.87	37.22
AB0203	Center and Lower Imprints	70.00	65.75	62.00	57.90

Setup fee: \$20(G)

Pricing is subject to change.

Stock colors with full-color artwork.  
Minimum order quantity of 6.

USD MSRP (C)

Product Size	Handle Drop	Finished Graphic Size	Product Wt. (Qty 6)	Media
17.75"W x 13.25"H x 8.5"D	9.25"	view online template	12 lbs.	EVA plastic

### Stock Flex Tote Colors

- White
- Crimson PMS 186
- Lilac PMS 2645
- Midnight Blue PMS 4145
- Lemon PMS 109
- Rose PMS 225
- Admiral PMS 7685
- Black

PMS colors are for reference only and may vary slightly from actual color.



Center imprint will be obstructed by holes on the tote.



Textured pattern on the bottom prevents the tote from tipping over.

## TRAVELER BAG



This bag combines durability and smart functionality to keep up with every adventure.

- Constructed of rPET polyester with a neutral gray recycled polyester lining
- Attaches to luggage with luggage sleeve for easy travel
- Available with vibrant full-color imprint or embroidery
- Minimum order quantity of six for full-color imprint; 12 for embroidery
- Embroidery is not eligible for Rush Service

### Full-Color Front Imprint

Item #	Description	6-11	12-24	25-49	50-149
AB0151	Traveler Bag	79.75	74.90	70.65	65.95

Setup fee: \$20(G)

Pricing is subject to change.

Stock fabric colors with full-color artwork.  
Minimum order quantity of 6.

USD MSRP (C)

### Embroidered

Item #	Description	12-24	25-49	50-74	75-99
ABE151	Traveler Bag	86.60	82.70	79.25	75.80

Setup (includes embroidery tape) fee: \$110(G)

Pricing is subject to change.

Stock fabric colors with embroidery (max 6 thread colors).  
Minimum order quantity of 12.

USD MSRP (C)

Product Size	Handle Drop	Finished Graphic Size	Product Wt. (Qty 6 / 12)	Media
25"W x 16"H x 8.5"D	8"	view online template	12 lbs. / 24 lbs.	rPET polyester

### Stock Traveler Bag Colors

- Indigo PMS 295
- Black

PMS colors are for reference only and may vary slightly from actual color.

Features a removable and adjustable shoulder strap with swivel hooks.



Features a front exterior pocket.

Shown in black with embroidery



Expandable zipper top with interior pockets allows for additional packing space.



Padded bottom compartment keeps footwear separate.

PRICES ARE SUBJECT TO CHANGE. No setup fee on orders placed via our website (excludes embroidery). Visit [showdowndisplays.com](http://showdowndisplays.com) for current pricing, graphic templates, product videos and assembly instructions. See pages 288-291 for order details.

SHOWDOWNDISPLAYS.COM · ASI 87188 · PPAI 254687 · SAGE 67383 · PPPC 20101202

IMPRINT      EMBROIDERY      production lead time after final proof approval  
**5-OR-10 DAYS**



Shown in gray/black with embroidery



Features a removable and adjustable shoulder strap with swivel hooks.

## CLASSIC DUFFEL



Whether heading to the gym or a weekend getaway, this durable bag is designed to keep you organized.

- Constructed of heavyweight 15 oz. cotton canvas
- Outside pocket
- Available with vibrant full-color imprint or embroidery
- Minimum order quantity of six for full-color imprint; 12 for embroidery
- Embroidery is not eligible for Rush Service

### Full-Color Front Imprint

Item #	Description	6-11	12-24	25-49	50-149
AB0121	Classic Duffel	25.61	24.59	23.82	23.05

Setup fee: \$20(G)

Pricing is subject to change.

Stock fabric colors with full-color artwork.  
Minimum order quantity of 6.

USD MSRP (C)

### Embroidered

Item #	Description	12-24	25-49	50-74	75-99
ABE121	Classic Duffel	34.08	32.55	31.18	29.82

Setup (includes embroidery tape) fee: \$110(G)

Pricing is subject to change.

Stock fabric colors with embroidery (max 6 thread colors).  
Minimum order quantity of 12.

USD MSRP (C)

Product Size	Finished Graphic Size	Product Wt. (Qty 6 / 12)	Media
20"W x 11"H x 11"D	view online template	8.4 lbs. / 16.8 lbs.	15 oz. cotton canvas

### Stock Classic Duffel Colors

- Indigo PMS 295
- Black
- Gray PMS 423 / Black

PMS colors are for reference only and may vary slightly from actual color.

## MVP DUFFEL



From workouts to weekend getaways, this bag keeps you organized and on-the-go in effortless style.

- Constructed of water-repellent rPET polyester with a recycled neutral gray polyester lining
- Features a 13" exterior padded laptop pocket with zippered closure
- Easy-carry handles with a snap closure and removable shoulder strap
- Attaches to luggage with luggage sleeve for easy travel
- Available with vibrant full-color imprint or embroidery
- Minimum order quantity of six for full-color imprint; 12 for embroidery
- Embroidery is not eligible for Rush Service

### Full-Color Front Imprint

Item #	Description	6-11	12-24	25-49	50-149
AB0141	MVP Duffel	102.30	98.15	95.10	92.05

Setup fee: \$20(G)

Pricing is subject to change.

Black with full-color artwork.  
Minimum order quantity of 6.

USD MSRP (C)

### Embroidered

Item #	Description	12-24	25-49	50-74	75-99
ABE141	MVP Duffel	109.20	104.30	99.95	95.60

Setup (includes embroidery tape) fee: \$110(G)

Pricing is subject to change.

Black with embroidery (max 6 thread colors).  
Minimum order quantity of 12.

USD MSRP (C)

Product Size	Finished Graphic Size	Product Wt. (Qty 6 / 12)	Media
20"W x 10.5"H x 10.5"D	view online template	17 lbs. / 34 lbs.	rPET polyester



Includes an extra deep side compartment and small exterior pockets for storage.



IMPRINT EMBROIDERY production lead time after final proof approval  
**5 -OR- 10 DAYS**

**PRICES ARE SUBJECT TO CHANGE.** No setup fee on orders placed via our website (excludes embroidery). Visit [showdowndisplays.com](http://showdowndisplays.com) for current pricing, graphic templates, product videos and assembly instructions. See pages 288-291 for order details.

## EXECUTIVE DUFFEL



Command attention with the luxurious Executive Duffel. This versatile bag is the perfect travel companion for the modern professional.

- Constructed of water-repellent rPET polyester with a neutral gray recycled polyester lining
- Features a 13" exterior padded laptop pocket with zippered closure
- Small exterior front pocket and zippered side pocket
- Interior mesh pockets and zippered fabric pocket
- Easy-carry handles with a snap closure
- Available with vibrant full-color imprint or embroidery
- Minimum order quantity of six for full-color imprint; 12 for embroidery
- Embroidery is not eligible for Rush Service



Features a removable and adjustable shoulder strap.



Shown with full-color imprint

### Full-Color Front Imprint

Item #	Description	6-11	12-24	25-49	50-149
AB0131	Executive Duffel	81.50	78.20	75.80	73.35

**Setup fee: \$20(G)** **Pricing is subject to change.**  
 Black with full-color artwork. USD MSRP (C)  
 Minimum order quantity of 6.

### Embroidered

Item #	Description	12-24	25-49	50-74	75-99
ABE131	Executive Duffel	88.35	84.35	80.80	77.30

**Setup (includes embroidery tape) fee: \$110(G)** **Pricing is subject to change.**  
 Black with embroidery (max 6 thread colors). USD MSRP (C)  
 Minimum order quantity of 12.

Product Size	Finished Graphic Size	Product Wt. (Qty 6 / 12)	Media
20"W x 13"H x 9"D	view online template	13 lbs. / 26 lbs.	rPET polyester



Side pocket for securing water bottles.



Extra deep side compartment is perfect for storing shoes.

## ON-THE-GO BELT BAG



This belt bag offers hands-free convenience keeping your essentials close with a comfy fit and easy-access compartments.

- Constructed of water-resistant recycled nylon with a recycled polyester lining
- Secure zippered back pocket
- Features an adjustable strap for waist or crossbody wear
- Available with vibrant full-color imprint or embroidery
- Minimum order quantity of six for full-color imprint; 12 for embroidery
- Embroidery is not eligible for Rush Service



Spacious main zippered compartment.



### Full-Color Front Imprint

Item #	Description	6-11	12-24	25-49	50-149
AB0021	On-the-Go Belt Bag	31.90	29.95	28.26	26.38

**Setup fee: \$20(G)** **Pricing is subject to change.**  
 Black with full-color artwork. USD MSRP (C)  
 Minimum order quantity of 6.

### Embroidered

Item #	Description	12-24	25-49	50-74	75-99
ABE021	On-the-Go Belt Bag	36.15	34.52	33.08	31.63

**Setup (includes embroidery tape) fee: \$110(G)** **Pricing is subject to change.**  
 Black with embroidery (max 6 thread colors). USD MSRP (C)  
 Minimum order quantity of 12.

Product Size	Finished Graphic Size	Product Wt. (Qty 6 / 12)	Media
8"W x 6"H x 2.5"D	view online template	3 lbs. / 6 lbs.	recycled nylon



Adjustable strap easily folds together for storage.

**PRICES ARE SUBJECT TO CHANGE.** No setup fee on orders placed via our website (excludes embroidery). Visit [showdowndisplays.com](http://showdowndisplays.com) for current pricing, graphic templates, product videos and assembly instructions. See pages 288-291 for order details. SHOWDOWNDISPLAYS.COM · ASI 87188 · PPAI 254687 · SAGE 67383 · PPPC 20101202

IMPRINT EMBROIDERY production lead time after final proof approval  
**5-OR-10 DAYS**



Shown with full-color imprint

## BACK-TO-BASICS BACKPACK



Simple, sleek and smart. This no-fuss backpack delivers everyday function with a modern edge.

- Constructed of rPET polyester with a recycled polyester lining
- Features two zippered top load compartments
- Available with vibrant full-color imprint or embroidery
- Minimum order quantity of six for full-color imprint; 12 for embroidery
- Embroidery is not eligible for Rush Service

### Full-Color Front Imprint

Item #	Description	6-11	12-24	25-49	50-149
AB0161	Back-to-Basics Backpack	90.65	87.00	84.30	81.60

**Setup fee: \$20(G)** **Pricing is subject to change.**  
 Black with full-color artwork. Minimum order quantity of 6. USD MSRP (C)

### Embroidered

Item #	Description	12-24	25-49	50-74	75-99
ABE161	Back-to-Basics Backpack	97.60	93.25	89.30	85.40

**Setup (includes embroidery tape) fee: \$110(G)** **Pricing is subject to change.**  
 Black with embroidery (max 6 thread colors). Minimum order quantity of 12. USD MSRP (C)

Product Size	Finished Graphic Size	Product Wt. (Qty 6 / 12)	Media
12"W x 17"H x 5.25"D	view online template	8 lbs. / 16 lbs.	rPET polyester



Features 16" padded laptop compartment.



Side pockets for securing water bottles.



Simply attach backpack to luggage with the luggage sleeve for easy travel.



Interior mesh pockets are great for storing smaller items.

## ON-THE-GO BACKPACK



Perfect for a busy lifestyle, this backpack has smart storage options.

- Constructed of water-repellent rPET polyester with a recycled polyester lining
- Available with vibrant full-color imprint or embroidery
- Minimum order quantity of six for full-color imprint; 12 for embroidery
- Embroidery is not eligible for Rush Service

### Full-Color Front Imprint

Item #	Description	6-11	12-24	25-49	50-149
AB0181	On-the-Go Backpack	75.75	72.70	70.45	68.15

**Setup fee: \$20(G)** **Pricing is subject to change.**  
 Black with full-color artwork. Minimum order quantity of 6. USD MSRP (C)

### Embroidered

Item #	Description	12-24	25-49	50-74	75-99
ABE181	On-the-Go Backpack	82.60	78.85	75.55	72.25

**Setup (includes embroidery tape) fee: \$110(G)** **Pricing is subject to change.**  
 Black with embroidery (max 6 thread colors). Minimum order quantity of 12. USD MSRP (C)

Product Size	Finished Graphic Size	Product Wt. (Qty 6 / 12)	Media
12"W x 16"H x 6"D	view online template	6 lbs. / 12 lbs.	rPET polyester



Extra-wide zippered compartment features 16" padded laptop compartment and interior mesh and fabric pockets.



Spacious zippered front compartment.



Simply attach backpack to luggage with the luggage sleeve for easy travel.



Side pockets for securing water bottles.

IMPRINT EMBROIDERY production lead time after final proof approval  
**5-OR-10 DAYS**

**PRICES ARE SUBJECT TO CHANGE.** No setup fee on orders placed via our website (excludes embroidery). Visit [showdowndisplays.com](http://showdowndisplays.com) for current pricing, graphic templates, product videos and assembly instructions. See pages 288-291 for order details.

## LEADER OF THE PACK BACKPACK



Designed as an all-in-one backpack for quick trips anywhere you want, from road trips to the office, this has it all.

- Constructed of water-repellent rPET polyester with a recycled polyester lining
- Exterior zippered pockets and one interior zippered pocket
- Available with vibrant full-color imprint or embroidery
- Minimum order quantity of six for full-color imprint; 12 for embroidery
- Embroidery is not eligible for Rush Service

### Full-Color Front Imprint

Item #	Description	6-11	12-24	25-49	50-149
AB0171	Leader of the Pack Backpack	104.60	100.40	97.25	94.10

**Setup fee: \$20(G)** Pricing is subject to change.  
 Black with full-color artwork. USD MSRP (C)  
 Minimum order quantity of 6.

### Embroidered

Item #	Description	12-24	25-49	50-74	75-99
ABE171	Leader of the Pack Backpack	111.60	106.50	102.10	97.60

**Setup (includes embroidery tape) fee: \$110(G)** Pricing is subject to change.  
 Black with embroidery (max 6 thread colors). USD MSRP (C)  
 Minimum order quantity of 12.

Product Size	Finished Graphic Size	Product Wt. (Qty 6 / 12)	Media
10.5"W x 18"H x 5"D	view online template	12.5 lbs. / 25 lbs.	rPET polyester

Buckle flap closure to keep item secure.



Shown with embroidery



Extra-wide opening with drawstring and deep front pocket with snap closure.



Features a side load external 16" padded laptop compartment.



Side pockets for securing water bottles.



Simply attach backpack to luggage with the luggage sleeve for easy travel.

## PICKLEBALL CARRY BAG



This bag helps organize your equipment with its spacious and simple design.

- Constructed of water-repellent rPET polyester with a recycled polyester lining
- Features two zippered compartments; one holds your paddles and one holds accessories
- Side pocket for securing a water bottle
- Available with vibrant full-color imprint or embroidery
- Minimum order quantity of six for full-color imprint; 12 for embroidery
- Embroidery is not eligible for Rush Service
- Pickleball paddles and balls sold separately; see pages 168-169

### Full-Color Front Imprint

Item #	Description	6-11	12-24	25-49	50-149
AB0031	Pickleball Carry Bag	61.50	57.75	54.50	50.90

**Setup fee: \$20(G)** Pricing is subject to change.  
 Black with full-color artwork. USD MSRP (C)  
 Minimum order quantity of 6.

### Embroidered

Item #	Description	12-24	25-49	50-74	75-99
ABE031	Pickleball Carry Bag	68.35	65.30	62.55	59.80

**Setup (includes embroidery tape) fee: \$110(G)** Pricing is subject to change.  
 Black with embroidery (max 6 thread colors). USD MSRP (C)  
 Minimum order quantity of 12.

Product Size	Finished Graphic Size	Product Wt. (Qty 6 / 12)	Media
15"W x 20"H x 8"D	view online template	6.5 lbs. / 13 lbs.	rPET polyester



Plastic hook to hang bag on fence during play.



Adjustable padded shoulder strap with buckle.



Includes a small front zippered pocket.

**PRICES ARE SUBJECT TO CHANGE.** No setup fee on orders placed via our website (excludes embroidery). Visit [showdowndisplays.com](http://showdowndisplays.com) for current pricing, graphic templates, product videos and assembly instructions. See pages 288-291 for order details. SHOWDOWNDISPLAYS.COM · ASI 87188 · PPAI 254687 · SAGE 67383 · PPPC 20101202

IMPRINT EMBROIDERY production lead time after final proof approval  
**5-OR-10 DAYS**

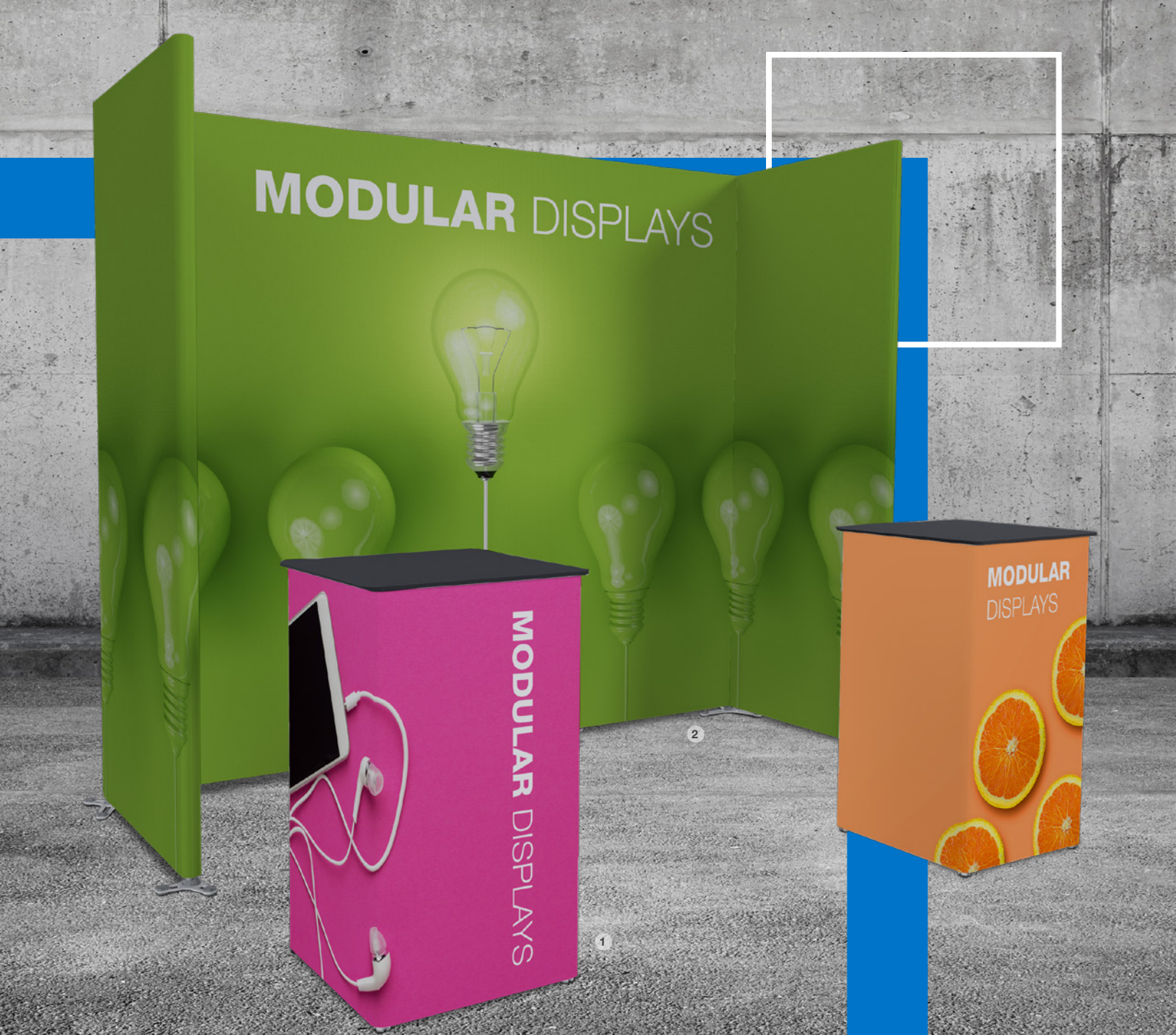

# MODULAR DISPLAYS

1. TRIGA® Go Counter page 226 2. TRIGA® Go U-Booth page 226

## have you considered...

- **size** how large is your display space?
- **location** where will these products be used?
- **use** are you looking to design your own booth or seeking tried-and-true product pairings?
- **lighting** will you require the product to be illuminated in the space?
- **accessories** do you need lights, shelves or monitor mounts?

## how to **DISPLAY**

Customizable modular displays come in various sizes and designs allowing you to tailor them to specific campaigns, themes and brand aesthetics. These durable displays can withstand frequent use making them a long-term investment.

# MODULAR DISPLAY FULL WALL COMPARISON CHART

BEST SELLERS ★ SUSTAINABLE ◆  PG #	FRAME WARRANTY	FULL WALL FRAME WIDTHS										FEATURES					GRAPHIC PANEL DETAILS		
		3'	4'	5'	6'	8'	10'	12'	15'	20'	SILICONE EDGE GRAPHICS	MODULAR CONNECTOR SETS	FOLDABLE FRAME	INTERNAL LED LIGHTS	ANGLED WALL OPTION	MULTIPLE HEIGHT OPTIONS	SINGLE-SIDED	DOUBLE-SIDED	MATERIAL
Journey ★ ◆ 216	2 years	X	X	X	X	X	X	X	X	X		✓	✓	✓				X	Recycled Polyester Knit
Astra 220	3 years	X		X		X	X					✓	✓		✓		✓	X	Backlit Woven Polyester
TRIGA® Go ◆ 224	3 years	X			X		X				X	✓				✓		X	Recycled Polyester Knit

## MODULAR DISPLAY HARDWARE

Journey



3'W wall

Astra



3'W x 8'H wall

3'W x 6.5'H wall

TRIGA® Go



3'W wall double-sided

3'W wall single-sided (back view)



The lightweight aluminum frame folds down for easy transportation.



Hardware can be assembled to be 6.5'H or 8'H. Replacement graphics are available online.



Join the top and bottom poles by simply turning the connector to the lock position.

Compatible with Journey and TRIGA® Go.



### Prime LED Light Kit

Item #	Description	1	2-5	6-11	12-24
150133	Single Light Kit	187.50	181.80	176.20	170.60

Kit Includes: Light and Soft Carry Case

### Modular Accessories



### Modular Hard Case

Item #	Description	1	2-5	6-11	12-24
220397	Hard Case with Two Wheels	434.50	421.50	408.50	395.50
220398	Hard Case with Four Wheels	599.50	581.50	563.50	545.50

Pricing is subject to change.  
USD MSRP (C)

# JOURNEY MODULAR DISPLAY SYSTEM



## Pack up your SEG and go with this lightweight, portable frame.

- Modular design allows you to expand and modify into various configurations
- Combine with other Journey components to craft a highly adaptable and visually striking display (sold separately)
- Artwork is dye sublimated on recycled polyester knit
- 100% recycled media is made with fibers recycled from plastic bottles
- 1.625" frame depth
- Aluminum frame can be recycled after use
- Tool-free assembly
- Booth kits are not eligible for Rush Service



Use the 90° Connector Set to build corners with your display.

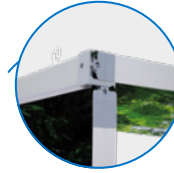

Bridge Connector Set easily attaches at the top of the frame to allow you to connect a Journey wall over the top of two Journey walls.



## Journey Modular Connector Sets



**180° Connector Set**  
Connect two Journey walls in a straight line.

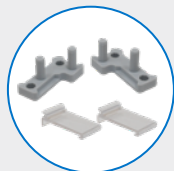

**90° Connector Set**  
Connect two Journey walls at a 90° angle.



**T Connector Set**  
Connect three Journey walls in a T shape.



**Bridge Connector Set**  
Install overhead Journey wall horizontally across the top of your Journey displays.



Scan to view Journey modular display in 3D



Shine with the Prime LED Light Kit (item #150133, sold separately) to bring more attention to your Journey display.



Walls include two graphic panels for a double-sided display.

### Journey Full Wall

Item #	Description	1	2-5	6-11	12-24
254860	3'W Kit	513.50	492.75	472.25	451.75
254863	4'W Kit	634.50	609.00	583.50	558.50
254866	5'W Kit	711.00	682.50	654.00	625.50
254869	6'W Kit	933.00	914.00	856.50	838.00
254872	8'W Kit	1051.00	1031.00	965.50	945.50
254875	10'W Kit	1650.00	1609.00	1516.00	1475.00
254950	12'W Kit	2016.00	1939.00	1852.00	1774.00
254953	15'W Kit	2675.00	2571.00	2457.00	2353.00
254956	20'W Kit	3372.00	3235.00	3098.00	2960.00

Setup fee: \$20(G)

Pricing is subject to change.

USD MSRP (C)

3'-5'W Kit Includes: Hardware, 2 Graphic Panels and Soft Carry Case  
 6'-10'W Kit Includes: Hardware, 2 Graphic Panels, 180° Connector Set and 2 Soft Carry Cases  
 12'-15'W Kit Includes: Hardware, 2 Graphic Panels, 2 - 180° Connector Sets and 3 Soft Carry Cases  
 20'W Kit Includes: Hardware, 2 Graphic Panels, 3 - 180° Connector Sets and 4 Soft Carry Cases

Description	Product Size	Finished Graphic Size	Product Wt.	Media
3'W	36.125"W x 90.625"H x 15.125"D	view online template	14 lbs.	recycled polyester knit
4'W	48.125"W x 90.625"H x 15.125"D	view online template	15 lbs.	recycled polyester knit
5'W	61"W x 90.625"H x 15.125"D	view online template	16.6 lbs.	recycled polyester knit
6'W	72"W x 90.625"H x 15.125"D	view online template	26.4 lbs.	recycled polyester knit
8'W	96"W x 90.625"H x 15.125"D	view online template	28.4 lbs.	recycled polyester knit
10'W	120"W x 90.625"H x 15.125"D	view online template	31.6 lbs.	recycled polyester knit
12'W	144"W x 90.625"H x 15.125"D	view online template	48.2 lbs.	recycled polyester knit
15'W	180"W x 90.625"H x 15.125"D	view online template	53 lbs.	recycled polyester knit
20'W	240"W x 90.625"H x 15.125"D	view online template	71.2 lbs.	recycled polyester knit

### 3'W Journey Half Wall

Item #	Description	1	2-5	6-11	12-24
254890	Kit	254.00	243.90	233.80	223.60

Setup fee: \$20(G)

Pricing is subject to change.

Kit Includes: Hardware, 2 Graphic Panels, 90° Connector Set and Soft Carry Case USD MSRP (C)

Product Size	Finished Graphic Size	Product Wt.	Media
36"W x 36.5"H x 15.125"D	view online template	11.8 lbs.	recycled polyester knit



3' half wall

### Journey Connector Sets

Item #	Description	1	2-5	6-11	12-24
254885	90° Connector Set	13.33	12.80	12.26	11.73
254884	180° Connector Set	57.75	55.45	53.15	50.85
254886	Bridge Connector Set	33.33	32.00	30.66	29.33
254887	T Connector Set	11.11	10.67	10.22	9.78

Pricing is subject to change.

USD MSRP (C)

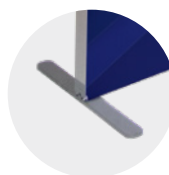

Slim feet stabilize the display and have a sleek look.



The lightweight aluminum frame folds for portability.



10' header shown with 3'W walls, 10'W wall and 90° Connector Set (sold separately)



Countertop and internal shelf supports up to 20 lbs.

### Journey Header

Item #	Description	1	2-5	6-11	12-24
254970	8'W Kit	504.00	483.75	463.50	443.25
254971	10'W Kit	615.00	590.00	565.50	541.00

Setup fee: \$20(G)

Pricing is subject to change.

Kit Includes: Hardware, 2 Graphic Panels and Soft Carry Case USD MSRP (C)

Description	Product Size	Finished Graphic Size	Product Wt.	Media
8'W	95.875"W x 11.875"H x 1.625"D	view online template	11.8 lbs.	recycled polyester knit
10'W	120"W x 11.875"H x 1.625"D	view online template	14 lbs.	recycled polyester knit

### Journey Counter

Item #	Description	1	2-5	6-11	12-24
254980	Kit	666.00	639.50	612.50	586.00

Setup fee: \$20(G)

Pricing is subject to change.

Kit Includes: Hardware, 3 Graphic Panels and Soft Carry Case USD MSRP (C)

Product Size	Finished Graphic Size	Product Wt.	Media
43.75"W x 40.25"H x 12.625"D	view online template	33.7 lbs.	recycled polyester knit



### 3' x 3' Journey Enclosure

Item #	Description	1	2-5	6-11	12-24
254630	Kit	1629.00	1564.00	1499.00	1434.00

Setup fee: \$20(G)

Pricing is subject to change.

Kit Includes: Hardware, 4 Graphic Panels, 4 Blank Interior Panels, 4 - 90° Connector Sets, 2 Top Corner Support Bars and Soft Carry Case USD MSRP (C)

### 5' x 9' Journey Enclosure

Item #	Description	1	2-5	6-11	12-24
254633	Kit	3652.00	3506.00	3360.00	3214.00

Setup fee: \$20(G)

Pricing is subject to change.

Kit Includes: Hardware, 6 Graphic Panels, 6 Blank Interior Panels, 4 - 90° Connector Sets, 2 - 180° Connector Sets, 4 Top Corner Support Bars and 8 Soft Carry Cases USD MSRP (C)

### 9' x 10' Journey Enclosure

Item #	Description	1	2-5	6-11	12-24
254636	Kit	4290.00	4118.00	3947.00	3775.00

Setup fee: \$20(G)

Pricing is subject to change.

Kit Includes: Hardware, 6 Graphic Panels, 6 Blank Interior Panels, 4 - 90° Connector Sets, 4 - 180° Connector Sets, 4 Top Corner Support Bars and 10 Soft Carry Cases USD MSRP (C)

Description	Product Size	Finished Graphic Size	Product Wt.	Media
3' x 3'	39.375"W x 90.625"H x 36.125"D	view online template	52.6 lbs.	recycled polyester knit
5' x 9'	111.25"W x 90.625"H x 67.75"D	view online template	126.4 lbs.	recycled polyester knit
9' x 10'	111.25"W x 90.625"H x 126.75"D	view online template	159.4 lbs.	recycled polyester knit

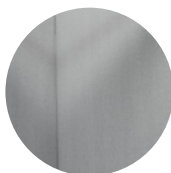

Interior panels are light gray.



Included top corner support bars keep your enclosure stable.



When shut, the door can be locked to keep your merchandise safe.



ENCLOSURES production lead time after final proof approval  
**4-OR-5 DAYS**

**PRICES ARE SUBJECT TO CHANGE.** No setup fee on orders placed via our website.

Visit [showdowndisplays.com](http://showdowndisplays.com) for current pricing, graphic templates, product videos and assembly instructions. See pages 288-291 for order details.

SHOWDOWNDISPLAYS.COM · ASI 87188 · PPAI 254687 · SAGE 67383 · PPPC 20101202

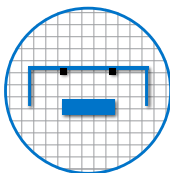

**Journey Modular Booth Kit 1**

Item #	Description	1	2-5	6-11	12-24
255520	Kit	3167.00	3100.00	2917.00	2850.00

**Setup fee: \$20(G)** Pricing is subject to change.

Kit Includes: Hardware, 9 Graphic Panels, 2 Prime LED Light Kits, USD MSRP (C)  
2 - 90° Connector Sets and 7 Soft Carry Cases

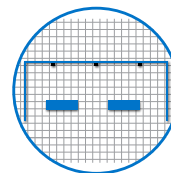

**Journey Modular Booth Kit 2**

Item #	Description	1	2-5	6-11	12-24
255521	Kit	6210.00	6055.00	5710.00	5555.00

**Setup fee: \$20(G)** Pricing is subject to change.

Kit Includes: Hardware, 12 Graphic Panels, 3 Prime LED Light Kits, USD MSRP (C)  
2 - 90° Connector Sets and 11 Soft Carry Cases

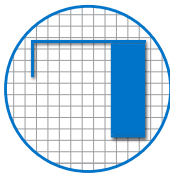

**Journey Modular Booth Kit 3**

Item #	Description	1	2-5	6-11	12-24
255522	Kit	3175.00	3071.00	2914.00	2810.00

**Setup fee: \$20(G)** Pricing is subject to change.

Kit Includes: Hardware, 8 Graphic Panels, 90° Connector Set, USD MSRP (C)  
Bridge Connector Set and 5 Soft Carry Cases

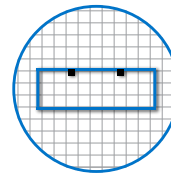

**Journey Modular Booth Kit 4**

Item #	Description	1	2-5	6-11	12-24
255523	Kit	3639.00	3574.00	3349.00	3284.00

**Setup fee: \$20(G)** Pricing is subject to change.

Kit Includes: Hardware, 8 Graphic Panels, 2 Prime LED Light Kits, USD MSRP (C)  
2 - 90° Connector Sets and 7 Soft Carry Cases

PLEASE NOTE: SUBSTITUTIONS NOT ALLOWED.

**PRICES ARE SUBJECT TO CHANGE.** No setup fee on orders placed via our website. Visit [showdowndisplays.com](http://showdowndisplays.com) for current pricing, graphic templates, product videos and assembly instructions. See pages 288-291 for order details.

SHOWDOWNDISPLAYS.COM · ASI 87188 · PPAI 254687 · SAGE 67383 · PPPC 20101202

production lead time  
after final proof approval  
**6 DAYS**

3'W x 8'H



3'W x 8'H

10'W x 8'H

3'W x 8'H shown with monitor mount

## ASTRA MODULAR DISPLAY SYSTEM



**Innovative, lightweight, and customizable display solution designed to captivate audiences with its seamless integration of LED lighting.**

- Modular design allows you to expand and modify into various configurations
- Combine with other Astra components to craft a highly adaptable and visually striking display (sold separately)
- Integrated LED lights on top and bottom provide edge-to-edge illumination
- Black PVC frame offers a sophisticated look while ensuring durability
- 4.75" frame depth
- Artwork is dye sublimated on backlit woven polyester
- SEG for easy graphic panel installation
- Includes two graphic panels for a double-sided display
- Includes a soft case with protective hard foam lining
- Tool-free assembly
- UL listed
- Booth kits are not eligible for Rush Service



Lightweight and portable snap-fit interlocking frame sets up in minutes.

### Astra Modular Connectors

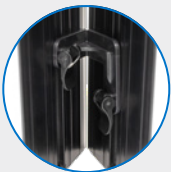

**45° Connector Set**  
Connect two Astra walls at a 45° angle.



**90° Connector Set**  
Connect two Astra walls at a 90° angle.

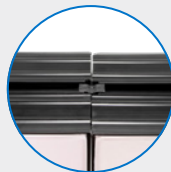

**180° Connector Set**  
Connect two Astra walls at a 180° angle.

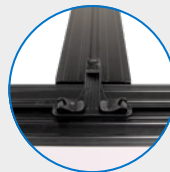

**T & Bridge Connector Set**  
Install overhead Astra wall horizontally across the top of your Astra displays or connect three Astra walls in a T shape.

### Add-Ons

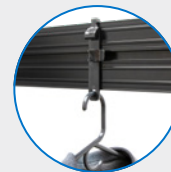

**Hanger Clip**  
Hang merch off your Astra frame.

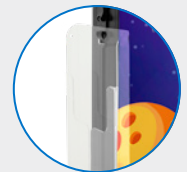

**Literature Holder**  
Hang to display literature. Pocket size: 9.25"W x 14"H x 1.25"D



**NEW**  
TABLETOP  
OPTION

**Astra Tabletop**

Item #	Description	1	2-5	6-11	12-24
255563	Kit	627.00	602.00	577.00	552.00

**Setup fee: \$20(G)** **Pricing is subject to change.**  
Kit Includes: Hardware, 2 Graphic Panels and Soft Carry Case USD MSRP (C)

Product Size	Finished Graphic Size	Product Wt.	Media
24"W x 24"H x 4.75"D	view online template	10.5 lbs.	backlit woven polyester

**6.5'H Astra Wall**

Item #	Description	1	2-5	6-11	12-24
255300	3'W Kit	1128.00	1082.00	1037.00	992.00
255303	5'W Kit	1788.00	1716.00	1645.00	1573.00
255306	8'W Kit	2915.00	2798.00	2682.00	2565.00
255309	10'W Kit	3289.00	3157.00	3026.00	2894.00

**Setup fee: \$20(G)** **Pricing is subject to change.**  
3' & 5'W Kit Includes: Hardware, 2 Graphic Panels and Soft Carry Case USD MSRP (C)  
8' & 10'W Kit Includes: Hardware, 2 Graphic Panels and Soft Carry Case with Wheels

Description	Product Size	Finished Graphic Size	Product Wt.	Media
3'W	37"W x 78.75"H x 15.75"D	view online template	28.2 lbs.	backlit woven polyester
5'W	61"W x 78.75"H x 19.625"D	view online template	39.6 lbs.	backlit woven polyester
8'W	97"W x 78.75"H x 19.625"D	view online template	50 lbs.	backlit woven polyester
10'W	119"W x 78.75"H x 19.625"D	view online template	56.8 lbs.	backlit woven polyester

**8'H Astra Wall**

Item #	Description	1	2-5	6-11	12-24
255312	3'W Kit	1210.00	1162.00	1113.00	1065.00
255314	5'W Kit	1898.00	1822.00	1746.00	1670.00
255316	8'W Kit	3053.00	2930.00	2808.00	2686.00
255318	10'W Kit	3454.00	3316.00	3178.00	3040.00

**Setup fee: \$20(G)** **Pricing is subject to change.**  
3' & 5'W Kit Includes: Hardware, 2 Graphic Panels and Soft Carry Case USD MSRP (C)  
8' & 10'W Kit Includes: Hardware, 2 Graphic Panels and Soft Carry Case with Wheels

Description	Product Size	Finished Graphic Size	Product Wt.	Media
3'W	37"W x 96"H x 15.75"D	view online template	28.6 lbs.	backlit woven polyester
5'W	61"W x 96"H x 19.625"D	view online template	40.4 lbs.	backlit woven polyester
8'W	97"W x 96"H x 19.625"D	view online template	51.3 lbs.	backlit woven polyester
10'W	119"W x 96"H x 19.625"D	view online template	58.4 lbs.	backlit woven polyester

**Astra Connector Sets**

Item #	Description	1	2-5	6-11	12-24
255350	45° Connector Set	49.50	47.52	45.54	43.56
255351	90° Connector Set	49.50	47.52	45.54	43.56
255352	180° Connector Set	22.00	21.12	20.24	19.36
255353	T Connector	22.00	21.12	20.24	19.36
255354	Bridge Connector Set	165.00	158.40	151.80	145.20

**Pricing is subject to change.**  
USD MSRP (C)

**Astra Hanger Clip**

Item #	Description	1	2-5	6-11	12-24
255355	Hanger Clip	22.00	21.12	20.24	19.36

**Pricing is subject to change.**  
USD MSRP (C)

**Astra Stabilizing Feet**

Item #	Description	1	2-5	6-11	12-24
255362	Stabilizing Feet (Set of 2)	77.00	73.90	70.85	67.75

**Pricing is subject to change.**  
USD MSRP (C)

**Astra Literature Holder**

Item #	Description	1	2-5	6-11	12-24
255360	Kit	55.00	52.80	50.60	48.40

**Pricing is subject to change.**  
Kit Includes: Literature Holder and Literature Holder Hanging Clip USD MSRP (C)

**HARDWARE-ONLY LEAD TIME: SHIPS SAME DAY WHEN ORDERED BEFORE 2 PM CENTRAL**

**PRICES ARE SUBJECT TO CHANGE.** No setup fee on orders placed via our website. Visit [showdowndisplays.com](http://showdowndisplays.com) for current pricing, graphic templates, product videos and assembly instructions. See pages 288-291 for order details.

SHOWDOWNDISPLAYS.COM · ASI 87188 · PPAI 254687 · SAGE 67383 · PPPC 20101202

production lead time  
after final proof approval  
**4 DAYS**



### Astra Counter

Item #	Description	1	2-5	6-11	12-24
255390	Kit	1034.00	992.50	951.50	910.00

**Setup fee: \$20(G)** **Pricing is subject to change.**  
 Kit Includes: Hardware, 2 Graphic Panels and Soft Carry Case USD MSRP (C)

Product Size	Finished Graphic Size	Product Wt.	Media
43.75"W x 40.25"H x 15.75"D	view online template	30.4 lbs.	backlit woven polyester

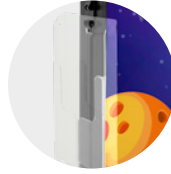

Add the Astra Literature Holder to the side of your counter to keep counter space open (sold separately).



Countertop supports up to 20 lbs.

### Astra Shelves

Item #	Description	Product Wt.	1	2-5	6-11	12-24
255340	Single Shelf Kit	9.8 lbs.	214.50	205.90	197.30	188.80
255341	Double Shelf Kit	15.2 lbs.	302.50	290.50	278.25	266.25

**Pricing is subject to change.**

Single Kit Includes: Shelf, 2 Shelf Brackets, 2 Stabilizer Feet and Soft Carry Case USD MSRP (C)  
 Double Kit Includes: 2 Shelves, 2 Shelf Brackets, 2 Stabilizer Feet and Soft Carry Case  
 Compatible with 3'W Astra Wall (sold separately).  
 Shelves support up to 15 lbs. Shelf size 36.75"W x 8.75"D.

### Astra Side Shelf

Item #	Description	Product Wt.	1	2-5	6-11	12-24
255342	Kit	7 lbs.	132.00	126.70	121.40	116.20

**Pricing is subject to change.**

Kit Includes: Shelf, Bracket and Soft Carry Case USD MSRP (C)  
 Shelf supports up to 10 lbs. Shelf size 12.25"W x 8.625"D.

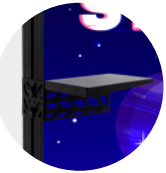

Side shelf can be displayed on the left or right side of any size wall and at any height.

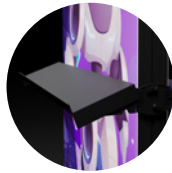

Single and double shelves can be attached at any height on a 3'W wall and displayed flat or at a 20° angle.



### Astra Monitor Mount

Item #	Description	Product Wt.	1	2-5	6-11	12-24
255330	Kit	11.8 lbs.	269.50	258.75	247.90	237.20

**Pricing is subject to change.**

Kit Includes: Mounting Hardware, 2 Stabilizer Feet and Soft Carry Case USD MSRP (C)  
 Compatible with 3'W Astra Wall (sold separately).  
 Max monitor size of 50" or 18 lbs. (monitor not included).



Monitor cord can be threaded through the channel on the frame to limit visibility.



Max monitor size of 50" (monitor not included).



production lead time after final proof approval

**4 DAYS**

**HARDWARE-ONLY LEAD TIME: SHIPS SAME DAY WHEN ORDERED BEFORE 2 PM CENTRAL**

**PRICES ARE SUBJECT TO CHANGE.** No setup fee on orders placed via our website.

Visit [showdowndisplays.com](http://showdowndisplays.com) for current pricing, graphic templates, product videos and assembly instructions. See pages 288-291 for order details.

SHOWDOWNDISPLAYS.COM · ASI 87188 · PPAI 254687 · SAGE 67383 · PPPC 20101202



**ASTRA PLUS KITS**  
INCLUDES HARD CASES

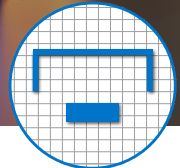

**Astra Modular Booth Kit 1**

Item #	Description	1	2-5	6-11	12-24
255530	6.5'H Kit	6585.00	6410.00	6050.00	5875.00
255532	8'H Kit	6905.00	6725.00	6345.00	6165.00

**Setup fee: \$20(G)** **Pricing is subject to change.**

Kit Includes: Hardware, 8 Graphic Panels, 2 - 90° Connector Sets and 4 Soft Carry Cases USD MSRP (C)

**Astra Plus Modular Booth Kit 1**

Item #	Description	1	2-5	6-11	12-24
255531	6.5'H Kit	8325.00	8100.00	7685.00	7460.00
255533	8'H Kit	8650.00	8415.00	7980.00	7750.00

**Setup fee: \$20(G)** **Pricing is subject to change.**

Kit Includes: Hardware, 8 Graphic Panels, 2 - 90° Connector Sets, 4 Soft Carry Cases and 3 Hard Cases with Wheels USD MSRP (C)

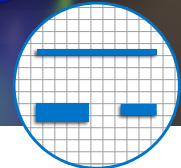

**Astra Modular Booth Kit 2**

Item #	Description	1	2-5	6-11	12-24
255534	6.5'H Kit	5720.00	5490.00	5260.00	5035.00
255536	8'H Kit	5970.00	5730.00	5490.00	5250.00

**Setup fee: \$20(G)** **Pricing is subject to change.**

Kit Includes: Hardware, 6 Graphic Panels, Monitor Mount and 4 Soft Carry Cases USD MSRP (C)

**Astra Plus Modular Booth Kit 2**

Item #	Description	1	2-5	6-11	12-24
255535	6.5'H Kit	7320.00	7075.00	6760.00	6520.00
255537	8'H Kit	7565.00	7315.00	6990.00	6740.00

**Setup fee: \$20(G)** **Pricing is subject to change.**

Kit Includes: Hardware, 6 Graphic Panels, Monitor Mount, 4 Soft Carry Cases and 3 Hard Cases with Wheels USD MSRP (C)

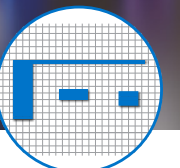

**Astra Modular Booth Kit 3**

Item #	Description	1	2-5	6-11	12-24
255538	8'H Kit	11910.00	11695.00	10925.00	10705.00

**Setup fee: \$20(G)** **Pricing is subject to change.**

Kit Includes: Hardware, 12 Graphic Panels, Monitor Mount, Double Shelf, 180° Connector Set, Bridge Connector Set and 8 Soft Carry Cases USD MSRP (C)

**Astra Plus Modular Booth Kit 3**

Item #	Description	1	2-5	6-11	12-24
255539	8'H Kit	14670.00	14370.00	13515.00	13210.00

**Setup fee: \$20(G)** **Pricing is subject to change.**

Kit Includes: Hardware, 12 Graphic Panels, Monitor Mount, Double Shelf, 180° Connector Set, Bridge Connector Set, 8 Soft Carry Cases and 5 Hard Cases with Wheels USD MSRP (C)



**Astra Modular Booth Kit 4**

Item #	Description	1	2-5	6-11	12-24
255540	8'H Kit	7425.00	7120.00	6815.00	6515.00

**Setup fee: \$20(G)** **Pricing is subject to change.**

Kit Includes: Hardware, 8 Graphic Panels, Monitor Mount, 90° Connector Set, Bridge Connector Set and 5 Soft Carry Cases USD MSRP (C)

**Astra Plus Modular Booth Kit 4**

Item #	Description	1	2-5	6-11	12-24
255541	8'H Kit	9165.00	8810.00	8455.00	8095.00

**Setup fee: \$20(G)** **Pricing is subject to change.**

Kit Includes: Hardware, 8 Graphic Panels, Monitor Mount, 90° Connector Set, Bridge Connector Set, 5 Soft Carry Cases and 3 Hard Cases with Wheels USD MSRP (C)

PLEASE NOTE: SUBSTITUTIONS NOT ALLOWED.

PRICES ARE SUBJECT TO CHANGE. No setup fee on orders placed via our website.

Visit [showdowndisplays.com](http://showdowndisplays.com) for current pricing, graphic templates, product videos and assembly instructions. See pages 288-291 for order details.

SHOWDOWNDISPLAYS.COM · ASI 87188 · PPAI 254687 · SAGE 67383 · PPPC 20101202

production lead time after final proof approval

**6 DAYS**

## TRIGA® GO MODULAR DISPLAY SYSTEM



The TRIGA® Go modular display system is a lightweight, portable display solution designed for easy setup and customization. It offers a sleek and professional presence for trade shows, events, and brand activations.

- Modular design allows you to expand and modify into various configurations
- Combine with other TRIGA® Go components to craft a highly adaptable and visually striking display (sold separately)
- Innovative fabric tension poles ensure a wrinkle-free finish
- One-piece wraparound graphic provides a polished look
- Available in single- and double-sided options
- Artwork is dye sublimated on recycled polyester knit
- 100% recycled media is made with fibers recycled from plastic bottles
- Compact and lightweight
- Packs flat for easy transport
- Tool-free assembly
- Warranties range between two and three years (see website for details)
- Booth kits are not eligible for Rush Service



TRIGA® Go Kit 3

Prime LED Light

10' U-Booth shown with monitor mount

20" counter

20" counter

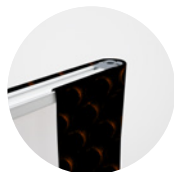

Graphic simply slides into grooves on the top and bottom rails.



Easily connect horizontal rails to vertical poles.



Join the top and bottom poles by turning the connector to the lock position.



Corner braces provide added stability to your display.



**TRIGA® Go Wall (Single-Sided)**

Item #	Description	1	2-5	6-11	12-24
255400	3'W Kit	709.00	680.50	652.00	623.50
255405	6'W Kit	1360.00	1306.00	1251.00	1197.00
255410	10'W Kit	1767.00	1696.00	1625.00	1555.00
255415	20'W Kit	3338.00	3204.00	3071.00	2937.00

Setup fee: \$20(G)

3'-10'W Kit Includes: Hardware, Graphic Panel and Soft Carry Case  
 20'W Kit Includes: Hardware, Graphic Panel and 2 Soft Carry Cases

Pricing is subject to change.

USD MSRP (C)

**TRIGA® Go Wall (Double-Sided)**

Item #	Description	1	2-5	6-11	12-24
255401	3'W Kit	791.50	759.50	728.00	696.50
255406	6'W Kit	1525.00	1464.00	1403.00	1342.00
255411	10'W Kit	1987.00	1907.00	1828.00	1748.00
255416	20'W Kit	3778.00	3626.00	3475.00	3324.00

Setup fee: \$20(G)

3'-10'W Kit Includes: Hardware, Graphic Panel and Soft Carry Case  
 20'W Kit Includes: Hardware, Graphic Panel and 2 Soft Carry Cases

Pricing is subject to change.

USD MSRP (C)

Description	Product Size	Finished Graphic Size	Product Wt. (Single / Double)	Media
3'W	43"W x 96.25"H x 12.875"D	view online template	15.8 lbs. / 17.2 lbs.	recycled polyester knit
6'W	80.5"W x 96.25"H x 12.875"D	view online template	27.8 lbs. / 30.6 lbs.	recycled polyester knit
10'W	118.5"W x 96.25"H x 12.875"D	view online template	33.2 lbs. / 37.4 lbs.	recycled polyester knit
20'W	230.25"W x 96.25"H x 12.875"D	view online template	67.9 lbs. / 76.3 lbs.	recycled polyester knit



6', 10' and 20' walls can be angled 90° at any interior vertical pole, allowing you to create unique shapes with the same graphic across the display.

6' shown at a 90° angle



Single-sided graphic wraps partially around the frame for a seamless front view.



Double-sided graphic has a partial overlap on the backside.



79"

38"

20"



20" countertop and internal shelf supports up to 50 lbs.; 38" and 79" countertop and internal shelves support up to 100 lbs.



**TRIGA® Go Counter**

Item #	Description	1	2-5	6-11	12-24
255450	20" W Kit	1250.00	1200.00	1150.00	1100.00
255453	38" W Kit	1534.00	1472.00	1411.00	1350.00
255456	79" W Kit	2555.00	2453.00	2351.00	2248.00

**Setup fee: \$20(G)**

**Pricing is subject to change.**

20" & 38" W Kit Includes: Hardware, Graphic Panel and 2 Soft Carry Cases USD MSRP (C)  
 79" W Kit Includes: Hardware, Graphic Panel and 3 Soft Carry Cases

Description	Product Size	Finished Graphic Size	Product Wt.	Media
20"W	23.5"W x 40"H x 23.5"D	view online template	36.4 lbs.	recycled polyester knit
38"W	41.125"W x 40"H x 23.5"D	view online template	52.75 lbs.	recycled polyester knit
79"W	78.625"W x 40"H x 23.5"D	view online template	92 lbs.	recycled polyester knit



10'



20'



Hardware is visible along the backside of the U-booth.

**TRIGA® Go U-Booth**

Item #	Description	1	2-5	6-11	12-24
255430	10' W Kit	2993.00	2873.00	2753.00	2633.00
255433	20' W Kit	4630.00	4445.00	4260.00	4074.00

**Setup fee: \$20(G)**

**Pricing is subject to change.**

10' W Kit Includes: Hardware, Graphic Panel and 2 Soft Carry Cases USD MSRP (C)  
 20' W Kit Includes: Hardware, Graphic Panel and 3 Soft Carry Cases

Description	Product Size	Finished Graphic Size	Product Wt.	Media
10'W	119.75"W x 96.25"H x 42.5"D	view online template	50.3 lbs.	recycled polyester knit
20'W	231.5"W x 96.25"H x 42.5"D	view online template	93 lbs.	recycled polyester knit

production lead time after final proof approval

**4 DAYS**

**PRICES ARE SUBJECT TO CHANGE.** No setup fee on orders placed via our website.

Visit [showdowndisplays.com](http://showdowndisplays.com) for current pricing, graphic templates, product videos and assembly instructions. See pages 288-291 for order details.

SHOWDOWNDISPLAYS.COM · ASI 87188 · PPAI 254687 · SAGE 67383 · PPPC 20101202



20" x 20"



36" x 20"



36" x 36"

**TRIGA® Go Towers**

Item #	Description	1	2-5	6-11	12-24
255500	20" x 20" Kit	1900.00	1824.00	1748.00	1672.00
255503	36" x 20" Kit	2100.00	2016.00	1932.00	1848.00
255506	36" x 36" Kit	2230.00	2141.00	2052.00	1962.00

**Setup fee: \$20(G)**

**Pricing is subject to change.**

Kit Includes: Hardware, Graphic Panel and Soft Carry Case

USD MSRP (C)

Description	Product Size	Finished Graphic Size	Product Wt.	Media
20" x 20"	24.5"W x 96.25"H x 24.5"D	view online template	30 lbs.	recycled polyester knit
36" x 20"	42"W x 96.25"H x 24.5"D	view online template	33 lbs.	recycled polyester knit
36" x 36"	42"W x 96.25"H x 42"D	view online template	36 lbs.	recycled polyester knit

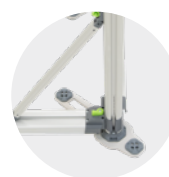

Keep a smaller footprint by displaying with feet pointing towards the inside of the tower.



Monitor mount securely attaches to poles; max monitor size of 50" (monitor not included).



Shown on 6'W TRIGA Go® wall (sold separately)

**TRIGA® Go Monitor Mount**

Item #	Description	Product Wt.	1	2-5	6-11	12-24
255472	Kit	9.5 lbs.	727.50	698.50	669.50	640.00

Pricing is subject to change.

Kit Includes: 2 Poles and Monitor Mount  
Max monitor size of 50" or 25 lbs. (monitor not included).

USD MSRP (C)

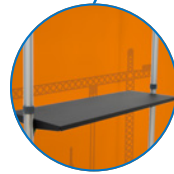

Each shelf supports up to 20 lbs.



Shown on 10'W TRIGA Go® wall (sold separately)

**TRIGA® Go Shelf**

Item #	Description	Product Wt.	1	2-5	6-11	12-24
255471	Kit	19 lbs.	770.00	739.00	708.50	677.50

Pricing is subject to change.

Kit Includes: 2 Poles and 2 Shelves  
Each shelf supports up to 20 lbs. Shelf size 36.25"W x 13.75"D.

USD MSRP (C)



Shown on 10'W TRIGA Go® wall (sold separately)

**TRIGA® Go Apparel Bar**

Item #	Description	Product Wt.	1	2-5	6-11	12-24
255468	Kit	14 lbs.	575.00	552.00	529.00	506.00

Pricing is subject to change.

Kit Includes: 2 Poles and 2 Apparel Hanging Bars  
Each bar supports up to 35 lbs.

USD MSRP (C)



Apparel bars easily attach to poles and each bar supports up to 35 lbs.

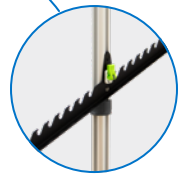

Each waterfall hanger supports up to 10 lbs.



Shown on 6'W TRIGA Go® wall (sold separately)

**TRIGA® Go Waterfall Hanger**

Item #	Description	Product Wt.	1	2-5	6-11	12-24
255470	Kit	2.8 lbs.	297.00	285.00	273.25	261.25

Pricing is subject to change.

Kit Includes: Pole and 2 Waterfall Hangers  
Each hanger supports up to 10 lbs.

USD MSRP (C)

when ordered before 2 pm central

**HARDWARE SHIPS  
SAME DAY**

**PRICES ARE SUBJECT TO CHANGE.** No setup fee on orders placed via our website.

Visit [showdowndisplays.com](http://showdowndisplays.com) for current pricing, graphic templates, product videos and assembly instructions. See pages 288-291 for order details.

SHOWDOWNDISPLAYS.COM · ASI 87188 · PPAI 254687 · SAGE 67383 · PPPC 20101202



10' wall

38" counter

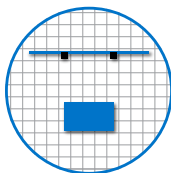

20' wall shown with monitor mount and Prime LED Light



79" counter

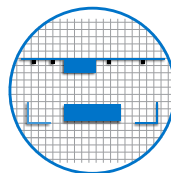

6' shown at a 90° angle

**TRIGA® Go Modular Booth Kit 1**

Item #	Description	1	2-5	6-11	12-24
255550	Kit	3884.00	3743.00	3580.00	3439.00

**Setup fee: \$20(G)** Pricing is subject to change.

Kit Includes: Hardware, 2 Graphic Panels, 2 Prime LED Light Kits and 6 Soft Carry Cases USD MSRP (C)

**TRIGA® Go Modular Booth Kit 2**

Item #	Description	1	2-5	6-11	12-24
255551	Kit	10275.00	9990.00	9455.00	9170.00

**Setup fee: \$20(G)** Pricing is subject to change.

Kit Includes: Hardware, Monitor Mount, 4 Graphic Panels, 4 Prime LED Light Kits and 11 Soft Carry Cases USD MSRP (C)



10'W U-Booth shown with monitor mount and Prime LED Light

20" counter

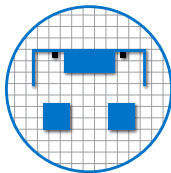

20'W U-Booth shown with monitor mount, shelves and Prime LED Light

38" counter

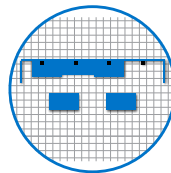

**TRIGA® Go Modular Booth Kit 3**

Item #	Description	1	2-5	6-11	12-24
255552	Kit	6485.00	6335.00	5965.00	5815.00

**Setup fee: \$20(G)** Pricing is subject to change.

Kit Includes: Hardware, 3 Graphic Panels, Monitor Mount, 2 Prime LED Light Kits and 8 Soft Carry Cases USD MSRP (C)

**TRIGA® Go Modular Booth Kit 4**

Item #	Description	1	2-5	6-11	12-24
255553	Kit	10070.00	9850.00	9260.00	9040.00

**Setup fee: \$20(G)** Pricing is subject to change.

Kit Includes: Hardware, 3 Graphic Panels, Monitor Mount, 2 Shelves, 4 Prime LED Light Kits and 11 Soft Carry Cases USD MSRP (C)

PLEASE NOTE: SUBSTITUTIONS NOT ALLOWED.

PRICES ARE SUBJECT TO CHANGE. No setup fee on orders placed via our website.

Visit showdowndisplays.com for current pricing, graphic templates, product videos and assembly instructions. See pages 288-291 for order details.

SHOWDOWNDISPLAYS.COM · ASI 87188 · PPAI 254687 · SAGE 67383 · PPPC 20101202

production lead time after final proof approval  
**6 DAYS**



# FLOOR DISPLAYS

1. Splash Display pages 246-247 2. Fusion Glo page 239 3. EuroFit Straight Wall pages 232-233

## have you considered...

- **size** what is the size of your space?
- **frequency** how often will you be setting up and taking down your display?
- **transport** how will this display be transported?
- **flexibility** will you be changing out your look frequently?
- **accessories** do you need lights for your display, and will power be available?

## how to **DISPLAY**

With high visibility, these large displays create spaces for impactful branding, engagement, and product presentations. Great for retail stores, trade shows, and promotional events. High quality displays enhance your brands professional look.

# EUROFIT DISPLAYS

## VERSATILE. MODULAR. CONNECTED.



Personalize your display by adding accessories (sold separately; see page 235).

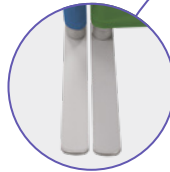

Slim swivel feet allow units to be paired at angles.

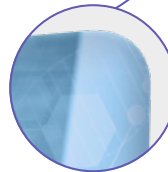

Fabric contours to the frame for a form-fitted look.



Tubular aluminum frame is lightweight and stable.

### EUROFIT FEATURES & BENEFITS



Joints are labeled for accurate step-by-step frame assembly.



Push-button connectors make assembly easy.



Artwork is dye sublimated on recycled polyester knit is made with fibers recycled from plastic bottles.

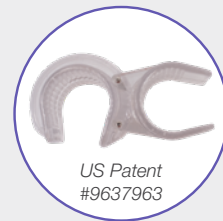

US Patent #9637963

Compatible displays can be hinged together using the EuroFit Connector.



Soft carry case included with all kits.

### EASE OF SETUP

Double-sided graphic covers easily slide on and off.

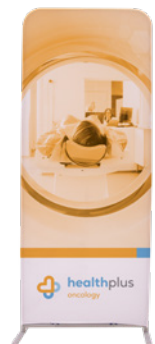
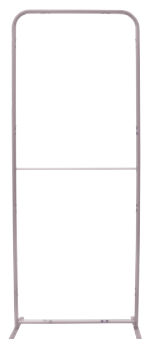

## EUROFIT STRAIGHT WALLS



The ever-popular EuroFit line offers many elegant and versatile display solutions.

- Artwork is dye sublimated on recycled polyester knit
- 100% recycled media is made with fibers recycled from plastic bottles
- Double-sided graphic cover is viewable from both the front and back of the display



### 54" H EuroFit Straight Wall

Item #	Description	1	2-5	6-11	12-24
256200	2'W Kit	250.00	242.50	235.00	227.50
256209	3'W Kit	314.50	305.00	295.50	286.00
256218	4'W Kit	384.50	373.00	361.25	349.75
256227	5'W Kit	461.00	447.25	433.50	419.50
256236	8'W Kit	640.00	620.50	601.50	582.50

Setup fee: \$20(G)

Pricing is subject to change.

Kit Includes: Hardware, Graphic Cover, EuroFit Connector and Soft Carry Case

USD MSRP (C)

Description	Product Size	Finished Graphic Size	Product Wt.	Media
2'W	24.5"W x 54"H x 19"D	view online template	6.6 lbs.	recycled polyester knit
3'W	36.5"W x 54"H x 19"D	view online template	7.5 lbs.	recycled polyester knit
4'W	48.5"W x 54"H x 19"D	view online template	8.25 lbs.	recycled polyester knit
5'W	60.5"W x 54"H x 19"D	view online template	9.25 lbs.	recycled polyester knit
8'W	96.5"W x 54"H x 19"D	view online template	13.8 lbs.	recycled polyester knit



### 72" H EuroFit Straight Wall

Item #	Description	1	2-5	6-11	12-24
256203	2'W Kit	291.00	282.25	273.50	265.00
256212	3'W Kit	384.50	364.00	347.00	330.25
256221	4'W Kit	486.50	472.00	457.50	442.75
256230	5'W Kit	605.50	587.50	569.00	551.00
255650	6'W Kit	722.00	700.50	679.00	657.00
256239	8'W Kit	819.00	794.00	769.50	745.00

Setup fee: \$20(G)

Pricing is subject to change.

Kit Includes: Hardware, Graphic Cover, EuroFit Connector and Soft Carry Case

USD MSRP (C)

Description	Product Size	Finished Graphic Size	Product Wt.	Media
2'W	24.5"W x 72"H x 19"D	view online template	7.5 lbs.	recycled polyester knit
3'W	36.5"W x 72"H x 19"D	view online template	8.25 lbs.	recycled polyester knit
4'W	48.5"W x 72"H x 19"D	view online template	9.5 lbs.	recycled polyester knit
5'W	60.5"W x 72"H x 19"D	view online template	11 lbs.	recycled polyester knit
6'W	72.5"W x 72"H x 19"D	view online template	11.2 lbs.	recycled polyester knit
8'W	96.5"W x 72"H x 19"D	view online template	15.5 lbs.	recycled polyester knit

production lead time after final proof approval

**4 DAYS**

**PRICES ARE SUBJECT TO CHANGE.** No setup fee on orders placed via our website.

Visit [showdowndisplays.com](http://showdowndisplays.com) for current pricing, graphic templates, product videos and assembly instructions. See pages 288-291 for order details.

SHOWDOWNDISPLAYS.COM · ASI 87188 · PPAI 254687 · SAGE 67383 · PPPC 20101202



Printed as PMS 354C for a green screen compatible backdrop. Available in 4'W and 5'W.

**90"H EuroFit Straight Wall**

Item #	Description	1	2-5	6-11	12-24
256206	2'W Kit	345.50	335.25	324.75	314.50
256215	3'W Kit	464.50	450.50	436.50	422.50
256224	4'W Kit	605.50	587.50	569.00	551.00
456520	4'W Green Screen Kit	605.50	587.50	569.00	551.00
256233	5'W Kit	700.00	679.00	658.00	637.00
456522	5'W Green Screen Kit	700.00	679.00	658.00	637.00
255657	6'W Kit	794.50	770.50	746.50	723.00
255180	8'W Kit	1063.00	1031.00	999.50	967.50
256251	10'W Kit	1216.00	1184.00	1160.00	1134.00
256427	20'W Kit	2355.00	2319.00	2251.00	2221.00
256424	30'W Kit	3505.00	3422.00	3350.00	3287.00

**Setup fee: \$20(G)** **Pricing is subject to change.**  
 Kit Includes: Hardware, Graphic Cover, EuroFit Connector and Soft Carry Case USD MSRP (C)  
 20' Display Includes: Hardware, Graphic Cover, 2 EuroFit Connectors and 2 Soft Carry Cases  
 30' Display Includes: Hardware, Graphic Cover, 6 EuroFit Connectors and 3 Soft Carry Cases

Description	Product Size	Finished Graphic Size	Product Wt.	Media
2'W	24.5"W x 91.25"H x 19"D	view online template	9.25 lbs.	recycled polyester knit
3'W	36.5"W x 91.25"H x 19"D	view online template	10.3 lbs.	recycled polyester knit
4'W	48.5"W x 91.25"H x 19"D	view online template	11.4 lbs.	recycled polyester knit
5'W	60.5"W x 91.25"H x 19"D	view online template	12.6 lbs.	recycled polyester knit
6'W	72.5"W x 91.25"H x 19"D	view online template	13.4 lbs.	recycled polyester knit
8'W	96.5"W x 91.25"H x 19"D	view online template	18 lbs.	recycled polyester knit
10'W	115.5"W x 91.25"H x 19"D	view online template	21.25 lbs.	recycled polyester knit
20'W	231"W x 91.25"H x 19"D	view online template	42.75 lbs.	recycled polyester knit
30'W	346.5"W x 91.25"H x 19"D	view online template	64.25 lbs.	recycled polyester knit

**120"H EuroFit Straight Wall**

Item #	Description	1	2-5	6-11	12-24
256512	8'W Kit	1261.00	1223.00	1185.00	1148.00
256515	10'W Kit	1650.00	1601.00	1551.00	1502.00

**Setup fee: \$20(G)** **Pricing is subject to change.**  
 Kit Includes: Hardware, Graphic Cover, EuroFit Connector and Soft Carry Case USD MSRP (C)

Description	Product Size	Finished Graphic Size	Product Wt.	Media
8'W	96"W x 119.5"H x 29"D	view online template	18.5 lbs.	recycled polyester knit
10'W	115.25"W x 119.5"H x 29"D	view online template	22.5 lbs.	recycled polyester knit





## LITEWAY EUROFIT STRAIGHT WALL



Our favorite EuroFit Straight Wall comes in a durable, black PVC option alongside the classic aluminum version. Perfect for budget-focused campaigns.

- Featuring PVC construction for cost-efficient production
- Artwork is dye sublimated on recycled polyester knit
- 100% recycled media is made with fibers recycled from plastic bottles
- Double-sided graphic cover is viewable from both the front and back of the display
- Graphic cover slips over the frame like a pillowcase
- Fabric contours to the frame for a form-fitted look

### 72"H LiteWay EuroFit Straight Wall

Item #	Description	1	2-5	6-11	12-24
256100	2'W Kit	185.22	179.61	174.08	168.56
256102	3'W Kit	241.19	226.53	214.63	202.81

**Setup fee: \$20(G)**

**Pricing is subject to change.**

Kit Includes: Hardware, Graphic Cover and Soft Carry Case

USD MSRP (C)

Description	Product Size	Finished Graphic Size	Product Wt.	Media
2'W	24.5"W x 72"H x 19"D	view online template	7 lbs.	recycled polyester knit
3'W	36.5"W x 72"H x 19"D	view online template	9.4 lbs.	recycled polyester knit



Push-button connectors make assembly a snap.



Joints are labeled for step-by-step frame assembly.



## EUROFIT PLUS



A perfect pairing of our best-selling EuroFit Straight Walls with a Case-to-Counter for promotion on the go.

- The EuroFit Straight Wall kit is the perfect backdrop for a stunning presentation
- Recycled polyester knit is a 100% recycled media made from plastic bottles
- A Case-to-Counter Conversion kit transforms the hard case into a podium

### 90"H EuroFit Straight Wall Plus

Item #	Description	1	2-5	6-11	12-24
256300	8'W Kit	1863.00	1807.00	1757.00	1701.00
256303	10'W Kit	2015.00	1960.00	1918.00	1867.00

**Setup fee: \$20(G)**

**Pricing is subject to change.**

Kit Includes: Hardware, Graphic Cover, EuroFit Connector, Soft Carry Case, Oval Hard Case, Oval Countertop and UltraFit Wrap Graphic

USD MSRP (C)

Description	Product Size	Finished Graphic Size	Product Wt.	Media
8'W	EuroFit: 96.5"W x 91.25"H x 19"D case: 26.25"W x 38.5"H x 17.5"D	view online template	43 lbs.	EuroFit: recycled polyester knit wrap: two-way stretch fabric
10'W	EuroFit: 115.5"W x 91.25"H x 19"D case: 26.25"W x 38.5"H x 17.5"D	view online template	46.75 lbs.	EuroFit: recycled polyester knit wrap: two-way stretch fabric

production lead time after final proof approval

**4 DAYS**

**PRICES ARE SUBJECT TO CHANGE.** No setup fee on orders placed via our website.

Visit [showdowndisplays.com](http://showdowndisplays.com) for current pricing, graphic templates, product videos and assembly instructions. See pages 288-291 for order details.

SHOWDOWNDISPLAYS.COM · ASI 87188 · PPAI 254687 · SAGE 67383 · PPPC 20101202

Mounting bracket is designed to hold monitors up to 23" in size (monitor not included).



Attaches to the top of 90"H EuroFit Straight Walls using the built-in clamps (excludes 2"W walls).

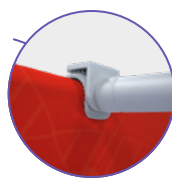

MDF shelves give you space to display merchandise.



Swivel castor wheels feature brakes so they can be locked into place.

Black shelf wraps around the edge of most EuroFit displays.

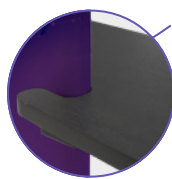

Same push-button assembly as EuroFit Walls.



**EuroFit Wall Shelf**

Item #	Description	Product Wt.	1	2-5	6-11	12-24
255123	Left Shelf Kit	7.5 lbs.	181.10	175.70	170.20	164.80
255124	Right Shelf Kit	7.5 lbs.	181.10	175.70	170.20	164.80

Pricing is subject to change.

Kit Includes: Hardware and Soft Carry Case  
Each shelf supports up to 10 lbs. Shelf size 20"W x 8"-11"D.

USD MSRP (C)

**EuroFit Cascade Merchandiser**

Item #	Description	Product Wt.	1	2-5	6-11	12-24
256390	Hanger Kit	14.4 lbs.	533.50	517.50	501.50	485.25
256391	Two-Shelf Kit	19 lbs.	533.50	517.50	501.50	485.25
256392	Three-Shelf Kit	22.5 lbs.	533.50	517.50	501.50	485.25

Pricing is subject to change.

Kit Includes: Hardware and Soft Carry Case  
Compatible with 90"H EuroFit Straight Walls (sold separately. Excludes 2"W walls).  
Each shelf supports up to 5 lbs., hanger supports up to 10 lbs.  
Recommended monitor size up to 23" (monitor not included).

USD MSRP (C)

**EuroFit Wheeled Feet**

Item #	Description	Product Wt.	1	2-5	6-11	12-24
255128	Wheeled Feet (Set of 2)	2.25 lbs.	69.90	67.80	65.70	63.60

Pricing is subject to change.

Not compatible with 120"H EuroFit Straight Wall

USD MSRP (C)

**EUROFIT WALL ACCESSORIES**



**EuroFit Light Clamp**

Item #	Description	1	2-5	6-11	12-24
255125	Light Clamp	7.56	7.33	7.11	6.88

Pricing is subject to change.

Clamp only. Ultimate LED Light Kit sold separately; see page 287.

USD MSRP (C)

**EuroFit Connector**

US Patent #9637963

Item #	Description	1	2-5	6-11	12-24
255122	Connector	6.89	6.71	6.58	6.43

Pricing is subject to change.

Included with most EuroFit kits  
See Kit Includes details

USD MSRP (C)



Wall Shelves

Hanger Merchandiser

Two-Shelf Merchandiser

Three-Shelf Merchandiser

Connector

Wheeled Feet; sold in a set of two

Light Clamp shown with Ultimate LED Light (sold separately)

EuroFit accessories shown on 90"H EuroFit Straight Walls (sold separately)

**PRICES ARE SUBJECT TO CHANGE.** No setup fee on orders placed via our website. Visit [showdowndisplays.com](http://showdowndisplays.com) for current pricing, graphic templates, product videos and assembly instructions. See pages 288-291 for order details.

SHOWDOWNDISPLAYS.COM · ASI 87188 · PPAI 254687 · SAGE 67383 · PPPC 20101202

when ordered before 2 pm central  
**HARDWARE SHIPS  
SAME DAY**



3' Incline

3' Two-Shelf Incline



Shelf attaches magnetically to the hardware and supports up to 20 lbs.

2' Apparel Incline

## EUROFIT EVOLUTION



An attractive incline and a vibrantly dye-sublimated graphic cover, you can see why this line extension is famous.

- Artwork is dye sublimated on recycled polyester knit
- 100% recycled media is made with fibers recycled from plastic bottles
- Graphic cover slips over the frame like a pillowcase
- Tool-free frame assembly allows for quick and easy setup
- Not compatible with EuroFit Connector or other EuroFit accessories

### EuroFit Evolution Incline

Item #	Description	1	2-5	6-11	12-24
258203	Kit	441.00	427.75	414.50	401.25

**Setup fee: \$20(G)**

**Pricing is subject to change.**

Kit Includes: Hardware, Graphic Cover and Soft Carry Case

USD MSRP (C)

Product Size	Finished Graphic Size	Product Wt.	Media
35.5"W x 71"H x 15.25"D	view online template	8.3 lbs.	recycled polyester knit

### EuroFit Evolution Apparel Incline

Item #	Description	1	2-5	6-11	12-24
258210	2'W Kit	482.25	467.75	453.25	438.75
258213	3'W Kit	584.50	567.00	549.50	532.00

**Setup fee: \$20(G)**

**Pricing is subject to change.**

Kit Includes: Hardware, Graphic Cover and Soft Carry Case

USD MSRP (C)

Description	Product Size	Finished Graphic Size	Product Wt.	Media
2'W	23.75"W x 59.25"H x 15.25"D	view online template	5.4 lbs.	recycled polyester knit
3'W	35.5"W x 71"H x 15.25"D	view online template	7.5 lbs.	recycled polyester knit

### EuroFit Evolution Two-Shelf Incline

Item #	Description	1	2-5	6-11	12-24
258240	2'W Kit	916.50	889.00	861.50	834.00
258243	3'W Kit	1050.00	1018.00	987.00	955.50
258246	4'W Kit	1194.00	1159.00	1123.00	1087.00

**Setup fee: \$20(G)**

**Pricing is subject to change.**

Kit Includes: Hardware, 3 Graphic Covers and Soft Carry Case

USD MSRP (C)

Description	Product Size	Finished Graphic Size	Product Wt.	Media
2'W	23.75"W x 59.25"H x 15.25"D	view online template	16 lbs.	recycled polyester knit
3'W	35.5"W x 71"H x 15.25"D	view online template	23 lbs.	recycled polyester knit
4'W	47.25"W x 71"H x 15.25"D	view online template	32.2 lbs.	recycled polyester knit



## EUROFIT INFINITY



The EuroFit Infinity creates a fun three-dimensional display for infinite viewing angles.

- This display is approximately 10' wide
- Artwork is dye sublimated on recycled polyester knit
- 100% recycled media is made with fibers recycled from plastic bottles
- Graphic cover slips over the frame like a pillowcase, then zips shut
- Heavy-duty zipper keeps the graphic cover secure and taut
- Fabric contours to the frame for a form-fitted look

### EuroFit Infinity

Item #	Description	1	2-5	6-11	12-24
255236	Kit	2050.00	1988.00	1927.00	1865.00

**Setup fee: \$20(G)**

**Pricing is subject to change.**

Kit Includes: Hardware, Graphic Cover, EuroFit Connector and Soft Carry Case

USD MSRP (C)

Product Size	Finished Graphic Size	Product Wt.	Media
118.5"W x 94.5"H x 16"D	view online template	33.5 lbs.	recycled polyester knit

production lead time after final proof approval

**4 DAYS**

**PRICES ARE SUBJECT TO CHANGE.** No setup fee on orders placed via our website.

Visit [showdowndisplays.com](http://showdowndisplays.com) for current pricing, graphic templates, product videos and assembly instructions. See pages 288-291 for order details.

SHOWDOWNDISPLAYS.COM · ASI 87188 · PPAI 254687 · SAGE 67383 · PPPC 20101202

## STANDARD SEG GLO



Add a lasting glow to your space with this lit SEG display.

- Easily change out graphic panel to update messaging
- Backlit SEG provides a glow effect
- Artwork is dye sublimated on backlit woven polyester
- Single-sided display
- 2.5" frame depth
- Ladder lights are mounted on a block-out back panel
- Tool-free assembly

### Standard SEG Glo

Item #	Description	1	2-5	6-11	12-24
254790	Kit	583.00	559.50	536.50	513.00

Setup fee: \$20(G)

Pricing is subject to change.

Kit Includes: Hardware, Back Panel with Ladder Lights, Graphic Panel and Soft Carry Case USD MSRP (C)

Product Size	Finished Graphic Size	Product Wt.	Media
39.375"W x 78.75"H x 13.75"D	view online template	14.3 lbs.	backlit woven polyester



Wall-mounted Standard and Value SEGs are available; see pages 108-109.



LED lights on the back panel of the display create a glow effect.

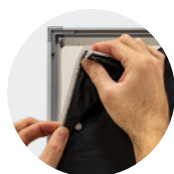

With a quick press of your thumb, the fabric's gasket edges are pushed into narrow channels built into the frame.

## DELUXE SEG GLO



Double your chances of being noticed with this double-sided lit SEG display.

- Easily change out graphic panels to update messaging
- LED lights built into the sides of the frame illuminate the SEG
- Artwork is dye sublimated on backlit woven polyester
- Includes two graphic panels for a double-sided display
- 3.125" frame depth
- Integrated magnet system allows multiple same-sized units to be linked together; use the included No-Gap Connectors for a tight seam
- Corner Connector can be used to link displays at a 90° angle (sold separately)
- Tool-free assembly

### Deluxe SEG Glo

Item #	Description	1	2-5	6-11	12-24
254800	3'W x 6.5'H Kit	894.50	858.50	823.00	787.00
254803	3'W x 8'H Kit	1113.00	1069.00	1024.00	979.50

Setup fee: \$20(G)

Pricing is subject to change.

Kit Includes: Hardware, 2 Graphic Panels, 4 No-Gap Connectors and Soft Carry Case USD MSRP (C)

Description	Product Size	Finished Graphic Size	Product Wt.	Media
3'W x 6.5'H	39.375"W x 79.25"H x 15.75"D	view online template	20.5 lbs.	backlit woven polyester
3'W x 8'H	39.375"W x 99"H x 15.75"D	view online template	23.2 lbs.	backlit woven polyester

### Deluxe SEG Glo & Fusion Glo Corner Connector

Item #	Description	1	2-5	6-11	12-24
254850	Corner Connector	13.33	12.80	12.26	11.73

Pricing is subject to change.

USD MSRP (C)

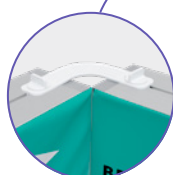

Corner Connector can be used to link to another Deluxe SEG at a 90° angle (sold separately).



LED lights on the sides of the frame create a glow effect.



Create a tight seam when linking to another Deluxe SEG Glo with included No-Gap Connectors.

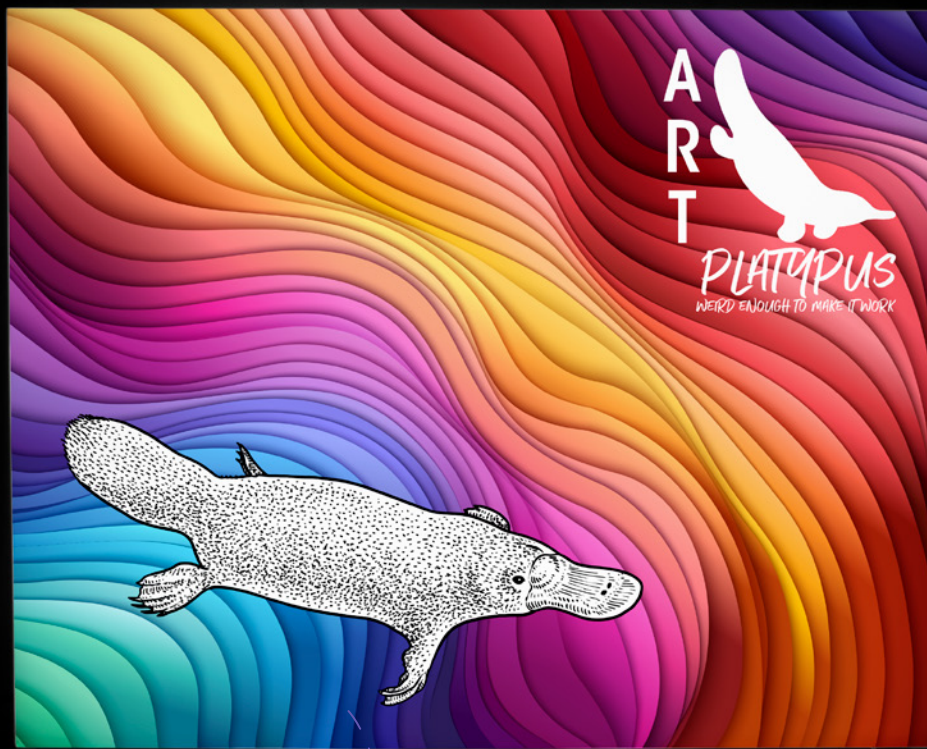

Included hard case with wheels is foam-lined to protect your SEG during storage and transport. See website for sizing information.

### PREMIER SEG GLO



**Illuminate your back wall with this LED lit SEG display!**

- Artwork is dye sublimated on backlit woven polyester
- Includes two graphic panels for a double-sided display
- SEG for easy graphic panel installation
- 4.75" frame depth
- Includes foam-lined hard case with wheels
- Tool-free assembly

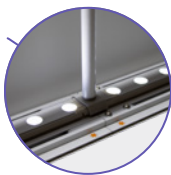

LED lights on the top and bottom of the frame create a glow effect.

#### Premier SEG Glo

Item #	Description	1	2-5	6-11	12-24
254840	8'W x 8'H Kit	3351.00	3217.00	3083.00	2949.00
254843	10'W x 8'H Kit	3929.00	3771.00	3614.00	3457.00

**Setup fee: \$20(G)**

**Pricing is subject to change.**

Kit Includes: Hardware, 2 Graphic Panels and Hard Case with Wheels

USD MSRP (C)

Description	Product Size	Finished Graphic Size	Product Wt.	Media
8'W x 8'H	94.25"W x 95.25"H x 16.5"D	view online template	80.6 lbs.	backlit woven polyester
10'W x 8'H	118.25"W x 95.25"H x 16.5"D	view online template	101.4 lbs.	backlit woven polyester



Pull tab lets you quickly remove SEG panel from the frame.



Accessible switch lets you easily turn the lights on and off.

production lead time after final proof approval

**4 DAYS**

**PRICES ARE SUBJECT TO CHANGE.** No setup fee on orders placed via our website.

Visit [showdowndisplays.com](http://showdowndisplays.com) for current pricing, graphic templates, product videos and assembly instructions. See pages 288-291 for order details.

SHOWDOWNDISPLAYS.COM · ASI 87188 · PPAI 254687 · SAGE 67383 · PPPC 20101202

## FUSION GLO



This light-up display is incredibly simple to set up so you're ready when it's glow time.

- Artwork is dye sublimated on backlit woven polyester
- Includes two graphic panels for a double-sided display
- SEG for easy graphic panel installation
- 4" frame depth
- Integrated magnet system allows multiple same-sized units to be linked together; use the included No-Gap Connectors for a tight seam
- Corner Connector can be used to link displays at a 90° angle (sold separately; see page 237)
- Tool-free assembly

### Fusion Glo

Item #	Description	1	2-5	6-11	12-24
254820	4'W x 4'H Kit	1091.00	1047.00	1004.00	960.00
254823	3'W x 6.5'H Kit	1063.00	1021.00	978.00	935.50
254826	3'W x 8'H Kit	1337.00	1283.00	1230.00	1176.00

Setup fee: \$20(G)

Pricing is subject to change.

Kit Includes: Hardware, 2 Graphic Panels, 4 No-Gap Connectors and Soft Carry Case USD MSRP (C)

Description	Product Size	Finished Graphic Size	Product Wt.	Media
4'W x 4'H	51.25"W x 51.75"H x 15.75"D	view online template	22.6 lbs.	backlit woven polyester
3'W x 6.5'H	39.5"W x 79.25"H x 15.75"D	view online template	24.2 lbs.	backlit woven polyester
3'W x 8'H	39.5"W x 99"H x 15.75"D	view online template	25.6 lbs.	backlit woven polyester



Lightweight aluminum frame easily pushes together for a tool-free assembly.



LED lights on the top and bottom of the frame create a glow effect.



## BRAVO EXPANDING DISPLAY



A durable, dependable expanding display built for long-term use.

- Single- or double-sided banner options available
- Frame poles are adjustable to accommodate a variety of banner sizes (see website for details)
- Reinforced joints keep the banner taut over an extended period of time
- Single-sided graphics are dye sublimated on recycled polyester knit
- 100% recycled media is made with fibers recycled from plastic bottles
- Double-sided graphics available on block-out fabric
- Small feet for a discreet footprint
- Custom banner sizes available (call for quote; restrictions may apply)

### Bravo Expanding Display

Item #	Description	1	2-5	6-11	12-24
254150	8' Single-Sided Kit	736.50	717.50	703.00	687.00
254154	8' Single-Sided Banner Only	357.00	347.75	340.75	333.00
254156	8' Double-Sided Kit	1025.00	998.00	978.00	956.00
254157	8' Double-Sided Banner Only	458.00	446.00	437.25	427.25
254151	10' Single-Sided Kit	892.50	869.00	852.00	832.50
254155	10' Single-Sided Banner Only	432.50	421.25	412.75	403.50
254158	10' Double-Sided Kit	1124.00	1095.00	1073.00	1048.00
254159	10' Double-Sided Banner Only	557.00	542.50	532.00	520.00

Setup fee: \$20(G)

Pricing is subject to change.

Kit Includes: Hardware, Graphic and Soft Carry Case USD MSRP (C)

Description	Product Size	Finished Graphic Size	Product Wt.	Media (Single / Double)
8'	94"W x 94.25"H x 14"D	view online template	20.2 lbs.	recycled polyester knit / block-out fabric
10'	118"W x 94.25"H x 14"D	view online template	22 lbs.	recycled polyester knit / block-out fabric



The vertical clamping system lets you adjust height.



Durable rounded corners.









PRICES ARE SUBJECT TO CHANGE. No setup fee on orders placed via our website.

Visit [showdowndisplays.com](http://showdowndisplays.com) for current pricing, graphic templates, product videos and assembly instructions. See pages 288-291 for order details.

SHOWDOWNDISPLAYS.COM · ASI 87188 · PPAI 254687 · SAGE 67383 · PPPC 20101202

production lead time  
after final proof approval  
**4 DAYS**

# POP-UP DISPLAY COMPARISON CHART

BEST SELLERS ★ SUSTAINABLE ◆ PG #	EASE OF SETUP	FRAME WARRANTY	FRAME DETAILS	PANEL INSTALLATION	PANEL MATERIAL	ADD-ON OPTIONS SOLD SEPARATELY
Splash ★ ◆ 246	●●●	2 years	 <ul style="list-style-type: none"> <li>high-grade 0.03" aluminum frame</li> <li>scissor construction</li> <li>bayonet locking system</li> <li>medium-weight nylon connecting hubs</li> </ul>	 Hook-and-loop fasteners	Recycled Polyester Knit Block-Out Fabric	Ultimate LED Light Kits
GeoMetrix 242	●●●●	1 year	 <ul style="list-style-type: none"> <li>lightweight 0.03" aluminum</li> <li>spring-action pop-up frame</li> </ul>	 Reinforced buttonholes on panels attach to pegs on the frame's hubs	Polyester Double Knit	Ultimate LED Light Kits
Deluxe GeoMetrix ★ 244	●●●	2 years	 <ul style="list-style-type: none"> <li>high-grade 0.03" aluminum frame</li> <li>scissor construction</li> <li>bayonet locking system</li> <li>medium-weight nylon connecting hubs</li> <li>rectangular extrusions for stability and shelf strength</li> </ul>	 Reinforced buttonholes on panels attach to pegs on the frame's hubs	Polyester Double Knit	Ultimate LED Light Kits Internal Shelf Stabilizer Feet Connector Shelf Edge Graphic Panels
ARISE 241	●●●●	Lifetime	 <ul style="list-style-type: none"> <li>high-grade 0.04" extruded aluminum frame</li> <li>self-locking scissor construction</li> <li>medium-weight nylon connecting hubs</li> </ul>	 Magnets connect bars to the frame for magnet-to-magnet panel registration	Fabric Panels Mural Panels	Internal Shelf

## PANEL MATERIAL

### Splash Pop-Ups



Face graphic panel



#### Block-Out Fabric

Block-out fabric is designed to prevent light from showing through the display. It is a good option for brightly lit areas.

#### Recycled Polyester Knit

Sustainable recycled polyester knit is made with fibers recycled from plastic bottles.

### GeoMetrix Pop-Ups

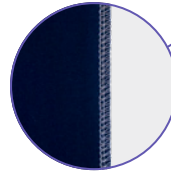

#### Polyester Double Knit

Stretches both ways to create a taut fit on GeoMetrix frames, giving you countless options for setting up a creative display.



Deluxe GeoMetrix 9-Quad Classic

### Traditional Pop-Ups

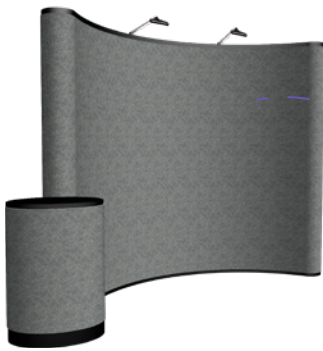

Full fabric panels

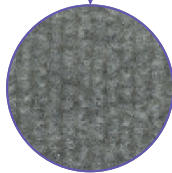

#### Hook-and-loop-receptive Fabric

High-quality polyester fiber.



Laminated center mural panels with fabric end panels



#### Mural Panel

Titan™ no-curl laminated media is rigid so it will not wrinkle or curl.



Laminated full mural panels

**Fabric Colors**

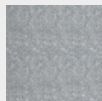

Charcoal PMS 424

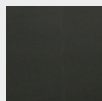

Lava PMS Black 6



10' curved full mural panel kit

**ARISE POP-UP DISPLAY**



This pop-up display is specifically engineered for the trade show professional.

- Choose between hook-receptive fabric or mural panels
- Panels attach to magnet bars for easy alignment
- Case-to-Counter Conversion Kit and Ultimate LED Double Light Kit included
- More kits available online

**8' Curved ARISE**

Item #	Description	1	2-5	6-11	12-24
332222	Full Fabric Panel Kit	2150.00	2064.00	1978.00	1892.00
332246	Mural Panels w/ Fabric Ends Kit	2600.00	2496.00	2444.00	2366.00
332254	Full Mural Panel Kit	3207.00	3111.00	3047.00	2951.00

Setup fee: \$20(G)

Pricing is subject to change.

Kit Includes: See Website

USD MSRP (C)

Product Size	Finished Graphic Size	Product Wt.	Media
100"W x 89.5"H x 26.25"D	view online template	83.25 lbs.	Titan™ no-curl laminated Media

**10' Curved ARISE**

Item #	Description	1	2-5	6-11	12-24
332223	Full Fabric Panel Kit	2450.00	2352.00	2303.00	2229.00
332247	Mural Panels w/ Fabric Ends Kit	2905.00	2818.00	2760.00	2673.00
332255	Full Mural Panel Kit	3505.00	3435.00	3365.00	3330.00

Setup fee: \$20(G)

Pricing is subject to change.

Kit Includes: See Website

USD MSRP (C)

Product Size	Finished Graphic Size	Product Wt.	Media
120.75"W x 89.5"H x 38.5"D	view online template	94 lbs.	Titan™ no-curl laminated Media

**10' Straight ARISE**

Item #	Description	1	2-5	6-11	12-24
332224	Full Fabric Panel Kit	2450.00	2352.00	2303.00	2229.00
332248	Mural Panels w/ Fabric Ends Kit	2905.00	2818.00	2760.00	2673.00
332256	Full Mural Panel Kit	3505.00	3435.00	3365.00	3330.00

Setup fee: \$20(G)

Pricing is subject to change.

Kit Includes: See Website

USD MSRP (C)

Product Size	Finished Graphic Size	Product Wt.	Media
109.5"W x 89.5"H x 12.5"D	view online template	86 lbs.	Titan™ no-curl laminated Media

**20' Gullwing ARISE**

Item #	Description	1	2-5	6-11	12-24
332226	Full Fabric Panel Kit	3931.00	3853.00	3774.00	3735.00
332250	Mural Panels w/ Fabric Ends Kit	5035.00	4832.00	4731.00	4580.00
332258	Full Mural Panel Kit	5725.00	5555.00	5440.00	5270.00

Setup fee: \$20(G)

Pricing is subject to change.

Kit Includes: See Website

USD MSRP (C)

Product Size	Finished Graphic Size	Product Wt.	Media
240"W x 89.5"H x 38.5"D	view online template	178 lbs.	Titan™ no-curl laminated Media

**Add-Ons**

Internal Shelf

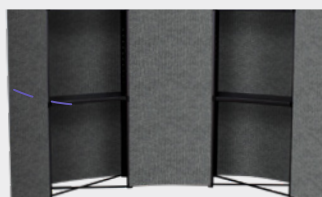

Shelf soft carry case holds up to four shelves.

**ARISE Internal Shelf**

Item #	Description	Product Wt.	1	2-5	6-11	12-24
290036	Curve Shelf	3 lbs.	167.80	164.40	161.00	159.40
220101	Soft Carry Case	1.25 lbs.	61.00	59.15	57.35	55.50

Pricing is subject to change.

Internal shelf supports up to 15 lbs. Shelf size 29"W x 12"D.

USD MSRP (C)



This kit turns an oval hard case into a podium. It includes an oval wrap, oval hard case and an oval countertop.

**Case-to-Counter Kit**

Item #	Description	Product Wt.	1	2-5	6-11	12-24
113030	Fabric Kit	4.75 lbs.	709.50	689.50	675.50	657.00
113031	Mural Kit	3.25 lbs.	985.00	951.50	923.50	890.00
113032	UltraFit Kit	2 lbs.	799.50	775.50	757.50	733.50

Setup fee: \$20(G)

Pricing is subject to change.

Kit Includes: Oval Countertop, Oval Wrap and Oval Hard Case

USD MSRP (C)

View online templates for Finished Graphic Sizes. Countertop supports up to 20 lbs.

FULL FABRIC PANEL KIT LEAD TIME: SHIPS IN 2 DAYS

PRICES ARE SUBJECT TO CHANGE. No setup fee on orders placed via our website. Visit showdowndisplays.com for current pricing, graphic templates, product videos and assembly instructions. See pages 288-291 for order details.

SHOWDOWNDISPLAYS.COM · ASI 87188 · PPAI 254687 · SAGE 67383 · PPPC 20101202

when ordered before 2 pm central  
**3** FOR **HARDWARE SHIPS SAME DAY**

## GEOMETRIX DISPLAY



These displays support a multitude of graphic configurations so you can show off your presentation in a unique way.

- 50% lighter than a standard pop-up display
- Artwork is dye sublimated on polyester double knit
- Additional kits and graphic panel kits available online



### GeoMetrix Centerpoint

Item #	Description	1	2-5	6-11	12-24
337121	Kit	1900.00	1843.00	1805.00	1748.00

Setup fee: \$20(G) Pricing is subject to change.

Kit Includes: Twelve-Quad Frame, 10 Graphic Panels and Soft Carry Case USD MSRP (C)

Product Size	Finished Graphic Size	Product Wt.	Media
119.38"W x 90.5"H x 11"D	view online template	23 lbs.	polyester double knit

### GeoMetrix 3-Quad Tower

Item #	Description	1	2-5	6-11	12-24
337126	Kit	600.00	576.00	564.00	546.00

Setup fee: \$20(G) Pricing is subject to change.

Kit Includes: Three-Quad Tower Frame, 3 Graphic Panels and Soft Carry Case USD MSRP (C)

Product Size	Finished Graphic Size	Product Wt.	Media
31.5"W x 90.5"H x 11"D	view online template	7.25 lbs.	polyester double knit



### GeoMetrix Classic

Item #	Description	1	2-5	6-11	12-24
337122	Kit	1561.00	1499.00	1467.00	1420.00

Setup fee: \$20(G) Pricing is subject to change.

Kit Includes: Nine-Quad Square Frame, 9 Graphic Panels and Soft Carry Case USD MSRP (C)

Product Size	Finished Graphic Size	Product Wt.	Media
90.5"W x 90.5"H x 11"D	view online template	18 lbs.	polyester double knit



### GeoMetrix Checkerboard

Item #	Description	1	2-5	6-11	12-24
337127	Kit	1561.00	1499.00	1467.00	1420.00

Setup fee: \$20(G) Pricing is subject to change.

Kit Includes: Nine-Quad Square Frame, 9 Graphic Panels and Soft Carry Case USD MSRP (C)

Product Size	Finished Graphic Size	Product Wt.	Media
90.5"W x 90.5"H x 11"D	view online template	18 lbs.	polyester double knit

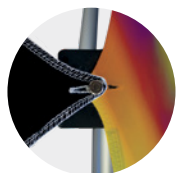

GeoMetrix pegs hold up to three panels each.

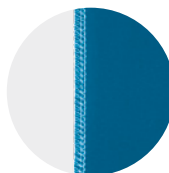

Graphic panels are finished with white stitching.



GeoMetrix folds down with installed graphics for easy transport.



Tabletop versions also available (see page 250).

production lead time after final proof approval

# 4 DAYS

## GEOMETRIX GRAPHIC PANELS



Create a look that is uniquely yours with our wide variety of graphic panels.

- Designed to attach to the frame at specific, predetermined angles (shown to the right)
- Artwork is dye sublimated on polyester double knit
- Hardware sold separately (complete frames only; see website for details)

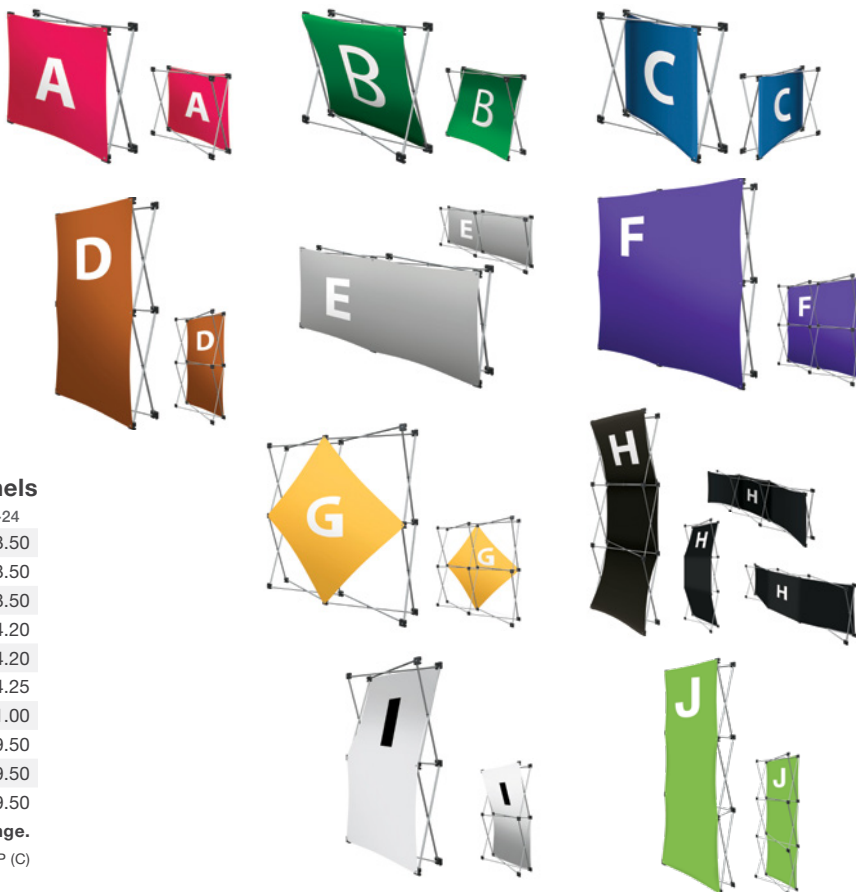

### GeoMatrix and Deluxe GeoMatrix Graphic Panels

Item #	Description	1	2-5	6-11	12-24
337000	Graphic Panel A	151.10	148.10	145.10	143.50
337001	Graphic Panel B	151.10	148.10	145.10	143.50
337002	Graphic Panel C	151.10	148.10	145.10	143.50
337003	Graphic Panel D	183.30	179.70	176.00	174.20
337004	Graphic Panel E	183.30	179.70	176.00	174.20
337005	Graphic Panel F	267.75	262.50	257.00	254.25
337006	Graphic Panel G	201.10	197.10	193.00	191.00
337007	Graphic Panel H	210.00	205.80	201.60	199.50
337008	Graphic Panel I	210.00	205.80	201.60	199.50
337021	Graphic Panel J	210.00	205.80	201.60	199.50

Setup fee: \$20(G)

Pricing is subject to change.

GeoMatrix pegs hold up to 3 panels each.  
Deluxe GeoMatrix pegs hold up to 6 panels each.  
View online templates for Finished Graphic Sizes.

USD MSRP (C)

Graphic panels shown on partial frames for illustrative purposes only.  
Partial frames not available for purchase.

## DELUXE GEOMETRIX BACK WALL



Block out background distractions by adding a stylish backdrop to your Deluxe GeoMatrix display.

- Super poly knit fabric with an opaque polyester block-out liner that features a double-sided silver acrylic coating
- Artwork is printed on both sides of the graphic panel; different artwork can be used on each side
- Buttonholes attach to corresponding pegs on Deluxe GeoMatrix frames
- Use with nine-quad and twelve-quad Deluxe GeoMatrix kits (see page 244)



Artwork is visible on both sides so your display stands out from every angle.

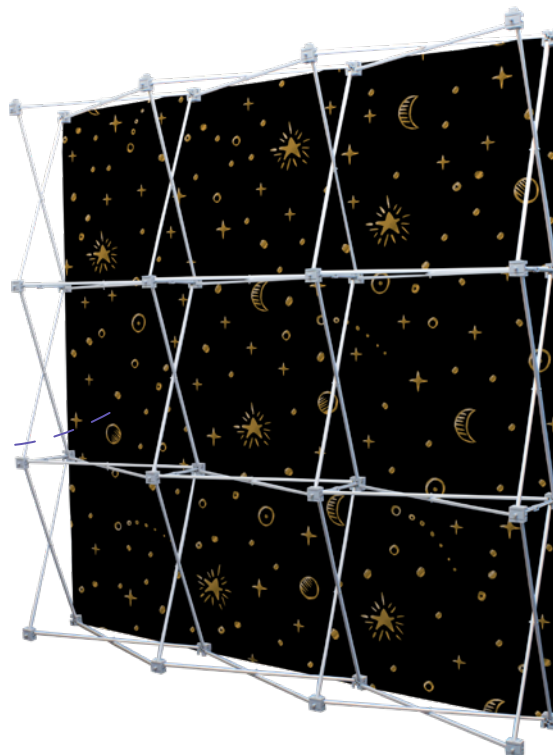

Nine-quad back wall shown on a Deluxe GeoMatrix nine-quad square frame (sold separately)

### Deluxe GeoMatrix Back Wall

Item #	Description	1	2-5	6-11	12-24
342060	Nine-Quad Back Wall	600.00	582.00	564.00	546.00
342061	Twelve-Quad Back Wall	722.00	700.50	679.00	657.00

Setup fee: \$20(G)

Pricing is subject to change.

Deluxe GeoMatrix pegs hold up to 6 panels each.  
View online templates for Finished Graphic Sizes.

USD MSRP (C)

PRICES ARE SUBJECT TO CHANGE. No setup fee on orders placed via our website.

Visit [showdowndisplays.com](http://showdowndisplays.com) for current pricing, graphic templates, product videos and assembly instructions. See pages 288-291 for order details.

SHOWDOWNDISPLAYS.COM · ASI 87188 · PPAI 254687 · SAGE 67383 · PPPC 20101202

production lead time  
after final proof approval  
**4 DAYS**

## DELUXE GEOMETRIX DISPLAY



A strong, durable frame supports multiple graphic panels and shelves so you have countless options for setting up a creative display.

- Setup and teardown can be done in seconds
- Artwork is dye sublimated on polyester double knit
- Aluminum frame with nylon plastic hubs
- Additional kits and graphic panel kits available online
- US Patent #9214104



12-Quad Classic

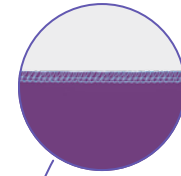

Graphic panels are finished with white stitching.



Shelf has rounded corners and supports up to 15 lbs.



Deluxe GeoMetric pegs hold up to six panels each.

### Add-Ons

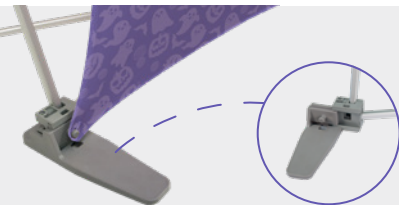

Feet slide into frame's hubs to keep the display stable when showcasing merchandise. Feet are not compatible with edge graphic panels.

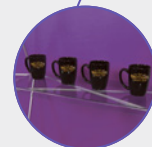

#### Deluxe GeoMetric Stabilizer Feet

Item #	Description	1	2-5	6-11	12-24
342070	Set of 4 for Three-Quad Tower Frame	29.89	28.99	28.10	27.20
342072	Set of 8 for Nine-Quad Square Frame	59.90	58.10	56.30	54.50
342073	Set of 10 for Twelve-Quad Frame	75.00	72.75	70.50	68.25

Pricing is subject to change.  
USD MSRP (C)

#### Deluxe GeoMetric Internal Shelves

Item #	Description	US Patent #D804,228			
		1	2-5	6-11	12-24
338050	Gray Internal Shelf	154.40	151.30	148.30	146.70
338068	Clear Internal Shelf	165.50	160.60	155.60	150.60

Pricing is subject to change.  
Each shelf supports up to 15 lbs. Shelf size 26.875"W x 12.125"D. USD MSRP (C)



### Deluxe GeoMetrix 9-Quad Header

Item #	Description	1	2-5	6-11	12-24
342004	Kit	1900.00	1843.00	1805.00	1748.00

**Setup fee: \$20(G)** Pricing is subject to change.

Kit Includes: Nine-Quad Square Frame, 6 Graphic Panels, 3 Internal Shelves and Soft Carry Case  
Shelves do not fit in provided soft carry case.  
See page 241 for shelf soft carry case.

Product Size	Finished Graphic Size	Product Wt.	Media
90"W x 89.5"H x 13"D	view online template	27 lbs.	polyester double knit



### Deluxe GeoMetrix 9-Quad Classic

Item #	Description	1	2-5	6-11	12-24
342006	Kit	1900.00	1843.00	1805.00	1748.00

**Setup fee: \$20(G)** Pricing is subject to change.

Kit Includes: Nine-Quad Square Frame, 4 Graphic Panels, 2 Internal Shelves and Soft Carry Case  
Shelves do not fit in provided soft carry case.  
See page 241 for shelf soft carry case.

Product Size	Finished Graphic Size	Product Wt.	Media
90"W x 89.5"H x 13"D	view online template	24 lbs.	polyester double knit



### Deluxe GeoMetrix 3-Quad Tower

Item #	Description	1	2-5	6-11	12-24
342010	Kit	866.50	849.00	832.00	823.50

**Setup fee: \$20(G)** Pricing is subject to change.

Kit Includes: Three-Quad Tower Frame, 3 Graphic Panels, 1 Internal Shelf and Soft Carry Case  
Shelf does not fit in provided soft carry case.  
See page 241 for shelf soft carry case.

Product Size	Finished Graphic Size	Product Wt.	Media
31.25"W x 89.5"H x 13"D	view online template	11 lbs.	polyester double knit



### Deluxe GeoMetrix 12-Quad Presenter

Item #	Description	1	2-5	6-11	12-24
342018	Kit	2244.00	2199.00	2154.00	2132.00

**Setup fee: \$20(G)** Pricing is subject to change.

Kit Includes: Twelve-Quad Frame, 5 Graphic Panels, 2 Internal Shelves and Soft Carry Case  
Shelves do not fit in provided soft carry case.  
See page 241 for shelf soft carry case.

Product Size	Finished Graphic Size	Product Wt.	Media
118"W x 89.5"H x 13"D	view online template	29.4 lbs.	polyester double knit



### Deluxe GeoMetrix 12-Quad Classic

Item #	Description	1	2-5	6-11	12-24
342000	Kit	2244.00	2199.00	2154.00	2132.00

**Setup fee: \$20(G)** Pricing is subject to change.

Kit Includes: Twelve-Quad Frame, 8 Graphic Panels, 2 Internal Shelves and Soft Carry Case  
Shelves do not fit in provided soft carry case.  
See page 241 for shelf soft carry case.

Product Size	Finished Graphic Size	Product Wt.	Media
118"W x 89.5"H x 13"D	view online template	30.5 lbs.	polyester double knit

**SHelves AND STABILIZER FEET LEAD TIME: SHIPS SAME DAY WHEN ORDERED BEFORE 2 PM CENTRAL**

**PRICES ARE SUBJECT TO CHANGE.** No setup fee on orders placed via our website.

Visit [showdowndisplays.com](http://showdowndisplays.com) for current pricing, graphic templates, product videos and assembly instructions. See pages 288-291 for order details.

SHOWDOWNDISPLAYS.COM · ASI 87188 · PPAI 254687 · SAGE 67383 · PPPC 20101202

production lead time  
after final proof approval

**4 DAYS**

## SPLASH DISPLAY



This pop-up display transforms from a compact unit to an impressive backdrop in minutes.

- All graphic panels are available in recycled polyester knit; 100% recycled media is made with fibers recycled from plastic bottles
- Block-out fabric is available for select displays
- Hook-and-loop fasteners make graphic panel installation simple
- Aluminum frame with nylon plastic hubs
- Tabletop version also available (see page 249)
- US Patent #9214104



10' tall straight with face graphic panel



10' curved with wrap graphic panel

3' straight with wrap graphic panel

### 3' Straight Splash

Item #	Description	1	2-5	6-11	12-24
341040	Recycled Polyester Knit Face Kit	522.00	503.00	483.25	464.50
342200	Block-Out Fabric Face Kit	639.00	619.50	607.00	587.50
341041	Recycled Polyester Knit Wrap Kit	627.50	609.00	596.50	577.50
342201	Block-Out Fabric Wrap Kit	739.00	712.00	684.00	657.00
341042	Recycled Polyester Knit 4-Sided Kit	994.50	954.50	934.50	905.00

Setup fee: \$20(G)

Pricing is subject to change.

Kit Includes: Frame, Graphic Panel and Soft Carry Case

USD MSRP (C)

Product Size 31"W x 89.5"H x 12.25"D  
 Finished Graphic Size view online template  
 Product Wt. 9.4 - 11.5 lbs.

### 10' Curved Splash

Item #	Description	1	2-5	6-11	12-24
341024	Recycled Polyester Knit Face Kit	1533.00	1503.00	1472.00	1457.00
342222	Block-Out Fabric Face Kit	1644.00	1611.00	1579.00	1562.00
341025	Recycled Polyester Knit Wrap Kit	1789.00	1753.00	1717.00	1699.00
342223	Block-Out Fabric Wrap Kit	1889.00	1851.00	1813.00	1794.00

Setup fee: \$20(G)

Pricing is subject to change.

Kit Includes: Frame, Graphic Panel and Soft Carry Case

USD MSRP (C)

Product Size 117.25"W x 89.5"H x 34"D  
 Finished Graphic Size view online template  
 Product Wt. 23.6 - 25.75 lbs.

### 10' Tall Straight Splash

Item #	Description	1	2-5	6-11	12-24
341030	Recycled Polyester Knit Face Kit	1889.00	1787.00	1703.00	1620.00
341031	Recycled Polyester Knit Wrap Kit	2088.00	1970.00	1874.00	1779.00

Setup fee: \$20(G)

Pricing is subject to change.

Kit Includes: Frame, Graphic Panel and Soft Carry Case

USD MSRP (C)

Product Size 119"W x 118.25"H x 12.25"D  
 Finished Graphic Size view online template  
 Product Wt. 30.5 - 31.5 lbs.



#### Block-Out Fabric

Block-out fabric is designed to prevent light from showing through the display. It is a good option for brightly lit areas.

#### Recycled Polyester Knit

Sustainable recycled polyester knit is made with fibers recycled from plastic bottles.

### 5' Straight Splash

Item #	Description	1	2-5	6-11	12-24
341046	Recycled Polyester Knit Face Kit	911.00	874.50	856.50	829.00
342204	Block-Out Fabric Face Kit	1022.00	981.00	961.00	930.00
341047	Recycled Polyester Knit Wrap Kit	1117.00	1072.00	1050.00	1016.00
342205	Block-Out Fabric Wrap Kit	1228.00	1179.00	1154.00	1117.00
341048	Recycled Polyester Knit 4-Sided Kit	1750.00	1680.00	1610.00	1540.00

Setup fee: \$20(G)

Pricing is subject to change.

Kit Includes: Frame, Graphic Panel and Soft Carry Case

USD MSRP (C)

Product Size 61"W x 89.5"H x 12.25"D  
 Finished Graphic Size view online template  
 Product Wt. 10.5 - 18.75 lbs.

### 8' Straight Splash

Item #	Description	1	2-5	6-11	12-24
341004	Recycled Polyester Knit Face Kit	1278.00	1252.00	1227.00	1214.00
342208	Block-Out Fabric Face Kit	1383.00	1356.00	1328.00	1314.00
341005	Recycled Polyester Knit Wrap Kit	1573.00	1532.00	1500.00	1465.00
342209	Block-Out Fabric Wrap Kit	1661.00	1617.00	1573.00	1535.00
341052	Recycled Polyester Knit 4-Sided Kit	2366.00	2224.00	2130.00	1988.00

Setup fee: \$20(G)

Pricing is subject to change.

Kit Includes: Frame, Graphic Panel and Soft Carry Case

USD MSRP (C)

Product Size 90"W x 89.5"H x 12.25"D  
 Finished Graphic Size view online template  
 Product Wt. 19.25 - 24.25 lbs.

### 8' Curved Splash

Item #	Description	1	2-5	6-11	12-24
341020	Recycled Polyester Knit Face Kit	1278.00	1252.00	1227.00	1214.00
342218	Block-Out Fabric Face Kit	1383.00	1356.00	1328.00	1314.00
341021	Recycled Polyester Knit Wrap Kit	1533.00	1503.00	1472.00	1457.00
342219	Block-Out Fabric Wrap Kit	1644.00	1611.00	1579.00	1562.00

Setup fee: \$20(G)

Pricing is subject to change.

Kit Includes: Frame, Graphic Panel and Soft Carry Case

USD MSRP (C)

Product Size 93"W x 89.5"H x 24"D  
 Finished Graphic Size view online template  
 Product Wt. 18.75 - 20.25 lbs.

### 10' Straight Splash

Item #	Description	1	2-5	6-11	12-24
341008	Recycled Polyester Knit Face Kit	1568.00	1519.00	1487.00	1454.00
342212	Block-Out Fabric Face Kit	1683.00	1640.00	1596.00	1559.00
341009	Recycled Polyester Knit Wrap Kit	1789.00	1753.00	1717.00	1699.00
342213	Block-Out Fabric Wrap Kit	1889.00	1851.00	1813.00	1794.00
341053	Recycled Polyester Knit 4-Sided Kit	2744.00	2580.00	2470.00	2305.00

Setup fee: \$20(G)

Pricing is subject to change.

Kit Includes: Frame, Graphic Panel and Soft Carry Case

USD MSRP (C)

Product Size 119"W x 89.5"H x 12.25"D  
 Finished Graphic Size view online template  
 Product Wt. 23.75 - 31 lbs.

### 20' Straight Splash

Item #	Description	1	2-5	6-11	12-24
341029	Recycled Polyester Knit Wrap Kit	2833.00	2776.00	2720.00	2691.00
342216	Block-Out Fabric Wrap Kit	2911.00	2853.00	2794.00	2765.00

Setup fee: \$20(G)

Pricing is subject to change.

Kit Includes: 2 Frames, Graphic Panel and 2 Soft Carry Cases

USD MSRP (C)

Product Size 237"W x 89.5"H x 12.25"D  
 Finished Graphic Size view online template  
 Product Wt. 47.75 - 49 lbs.



20' straight with wrap graphic panel



8' curved with face graphic panel

5' straight with wrap graphic panel

### Kit Options



**Face Graphic Kit**  
 Graphic panel covers the front of the frame.



**Wrap Graphic Kit**  
 Graphic panel covers the front and sides, extending to the first column of plastic hubs on the back of the frame. Back of the frame is not covered.



**4-Sided Graphic Kit**  
 Graphic panel wraps all the way around the frame, covering the front, back and two sides.





# TABLETOP DISPLAYS

1. Micro Teardrop Sail Sign page 257 2. Deluxe Mini Retractor page 256 3. EuroFit Tabletop Straight Wall page 252

## have you considered...

- **size** what is the size of your table?
- **flexibility** will you be changing the message often?
- **frequently** how often will you be using the display?
- **transport** how will this display be transported?
- **message** do you need a single- or double-sided display?

## how to **DISPLAY**

Tabletop displays are portable, versatile and there are numerous options to fit in any space you need. They allow for targeted marketing with focused messaging. Use them in a booth, a presentation area, or point of purchase.

## SPLASH TABLETOP DISPLAY



This display assembles in minutes and is easily transportable between events.

- Lightweight aluminum frame
- Hook-and-loop fasteners make graphic panel installation simple
- Graphic panel available in recycled polyester knit or block-out fabric
- Recycled polyester knit is a 100% recycled media made from plastic bottles
- Available in straight or curved versions
- Floor display kits also available (see pages 246-247)
- US Patent #9214104



Straight face kit on a 6' Standard throw shown in yellow (sold separately; see page 12)



Curved wrap kit on a 6' Standard throw shown in yellow (sold separately; see page 12)

### 6' Straight Splash Tabletop Display

Item #	Description	1	2-5	6-11	12-24
341000	Recycled Polyester Knit Face Kit	894.00	858.00	822.50	786.50
342226	Block-Out Fabric Face Kit	1005.00	965.00	945.00	915.00
341001	Recycled Polyester Knit Wrap Kit	1098.00	1054.00	1010.00	966.00
342227	Block-Out Fabric Wrap Kit	1211.00	1175.00	1150.00	1114.00

**Setup fee: \$20(G)** **Pricing is subject to change.**  
Kit Includes: Frame, Graphic Panel and Soft Carry Case USD MSRP (C)

### 6' Curved Splash Tabletop Display

Item #	Description	1	2-5	6-11	12-24
341012	Recycled Polyester Knit Face Kit	894.00	858.00	822.50	786.50
342230	Block-Out Fabric Face Kit	1005.00	965.00	945.00	915.00
341013	Recycled Polyester Knit Wrap Kit	1098.00	1054.00	1010.00	966.00
342231	Block-Out Fabric Wrap Kit	1211.00	1175.00	1150.00	1114.00

**Setup fee: \$20(G)** **Pricing is subject to change.**  
Kit Includes: Frame, Graphic Panel and Soft Carry Case USD MSRP (C)

Description	Product Size	Finished Graphic Size	Product Wt. (Face / Wrap)
straight	61"W x 61"H x 14"D	view online template	10.5 lbs. / 11 lbs.
curved	56"W x 61"H x 18"D	view online template	10.5 lbs. / 11 lbs.

**Block-Out Fabric**  
Block-out fabric is designed to prevent light from showing through the display. It is a good option for brightly lit areas.

**Recycled Polyester Knit**  
Sustainable recycled polyester knit is made with fibers recycled from plastic bottles.



High-grade aluminum frame with bayonet locking system keeps the display stable.



Graphic panels install using hook-and-loop fasteners.

**PRICES ARE SUBJECT TO CHANGE.** No setup fee on orders placed via our website. Visit [showdowndisplays.com](http://showdowndisplays.com) for current pricing, graphic templates, product videos and assembly instructions. See pages 288-291 for order details.

SHOWDOWNDISPLAYS.COM · ASI 87188 · PPAI 254687 · SAGE 67383 · PPPC 20101202

production lead time after final proof approval  
**4 DAYS**

## MICRO GEOMETRIX DISPLAY



Create a variety of multidimensional displays in seconds with the Micro GeoMetrix display.

- Lightweight aluminum frame with plastic hubs
- Artwork is dye sublimated on polyester double knit
- Additional kits, graphic panels and hardware available online

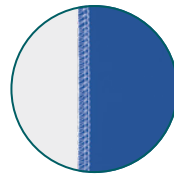

Graphic panels are finished with white stitching.



### Micro GeoMetrix Grid

Item #	Description	1	2-5	6-11	12-24
337205	Kit	496.50	476.75	457.00	437.00

Setup fee: \$20(G)

Pricing is subject to change.

Kit Includes: Six-Quad Horizontal Frame, 6 Graphic Panels and Soft Carry Case

USD MSRP (C)

Product Size	Finished Graphic Size	Product Wt.	Media
46"W x 32.12"H x 9.62"D	view online template	6.5 lbs.	polyester double knit

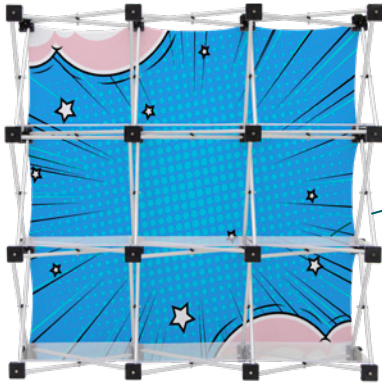

Display merchandise on included shelves; each shelf holds up to 5 lbs.

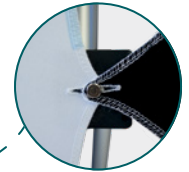

Pegs can hold up to three panels. Buttonholes are reinforced with white stitching to prevent tearing.

### Micro GeoMetrix Presenter

Item #	Description	1	2-5	6-11	12-24
337242	Nine-Quad Kit	1170.00	1123.00	1061.00	1023.00
337243	Twelve-Quad Kit	1367.00	1337.00	1260.00	1218.00

Setup fee: \$20(G)

Pricing is subject to change.

Nine-Quad Kit Includes: Square Frame, Back Wall, 9 Internal Clear

USD MSRP (C)

Shelves and 2 Soft Carry Cases

Twelve-Quad Kit Includes: Horizontal Frame, Back Wall, 12 Internal Clear

Shelves and 3 Soft Carry Cases

Description	Product Size	Finished Graphic Size	Product Wt.	Media
nine-quad	46"W x 46.75"H x 9.62"D	view online template	16 lbs.	polyester double knit
twelve-quad	60.75"W x 46.75"H x 9.62"D	view online template	21.4 lbs.	polyester double knit

### Micro GeoMetrix Column

Item #	Description	1	2-5	6-11	12-24
337201	Kit	264.25	253.75	243.20	232.60

Setup fee: \$20(G)

Pricing is subject to change.

Kit Includes: Three-Quad Vertical Frame, 3 Graphic Panels and Soft Carry Case

USD MSRP (C)

Product Size	Finished Graphic Size	Product Wt.	Media
16.62"W x 46.75"H x 9.62"D	view online template	4 lbs.	polyester double knit



### Micro GeoMetrix Centerpost

Item #	Description	1	2-5	6-11	12-24
337211	Kit	720.50	691.50	663.00	634.00

Setup fee: \$20(G)

Pricing is subject to change.

Kit Includes: Twelve-Quad Horizontal Frame, 8 Graphic Panels and Soft Carry Case

USD MSRP (C)

Product Size	Finished Graphic Size	Product Wt.	Media
60.75"W x 46.75"H x 9.62"D	view online template	12.5 lbs.	polyester double knit



### Micro GeoMetrix Classic

Item #	Description	1	2-5	6-11	12-24
337207	Kit	573.50	550.50	527.50	504.50

Setup fee: \$20(G)

Pricing is subject to change.

Kit Includes: Nine-Quad Square Frame, 5 Graphic Panels and Soft Carry Case

USD MSRP (C)

Product Size	Finished Graphic Size	Product Wt.	Media
46"W x 46.75"H x 9.62"D	view online template	9.25 lbs.	polyester double knit

production lead time after final proof approval

**4 DAYS**

**PRICES ARE SUBJECT TO CHANGE.** No setup fee on orders placed via our website.

Visit [showdowndisplays.com](http://showdowndisplays.com) for current pricing, graphic templates, product videos and assembly instructions. See pages 288-291 for order details.

SHOWDOWNDISPLAYS.COM · ASI 87188 · PPAI 254687 · SAGE 67383 · PPPC 20101202



## MICRO GEOMETRIX GRAPHIC PANELS



Graphic panels can be ordered separately so you can create a look that's uniquely yours.

- Designed to attach to the frame at specific angles (as shown)
- Artwork is dye sublimated on polyester double knit
- Graphic panels are finished with white stitching
- Hardware sold separately (complete frames only; see website for details)

### Micro GeoMetrix Graphic Panels

Item #	Description	1
337009	Graphic Panel A	81.05
337010	Graphic Panel B	81.05
337011	Graphic Panel C	81.05
337012	Graphic Panel D	96.50
337013	Graphic Panel E	96.50
337014	Graphic Panel F	130.10
337015	Graphic Panel G	96.50
337016	Graphic Panel H	111.90
337017	Graphic Panel I	96.50
337018	Graphic Panel J	111.90
337019	Graphic Panel K	111.90

**Setup fee: \$20(G)** Pricing is subject to change.  
 Micro GeoMetrix pegs hold up to 3 panels each. USD MSRP (C)  
 View online templates for finished graphic sizes.

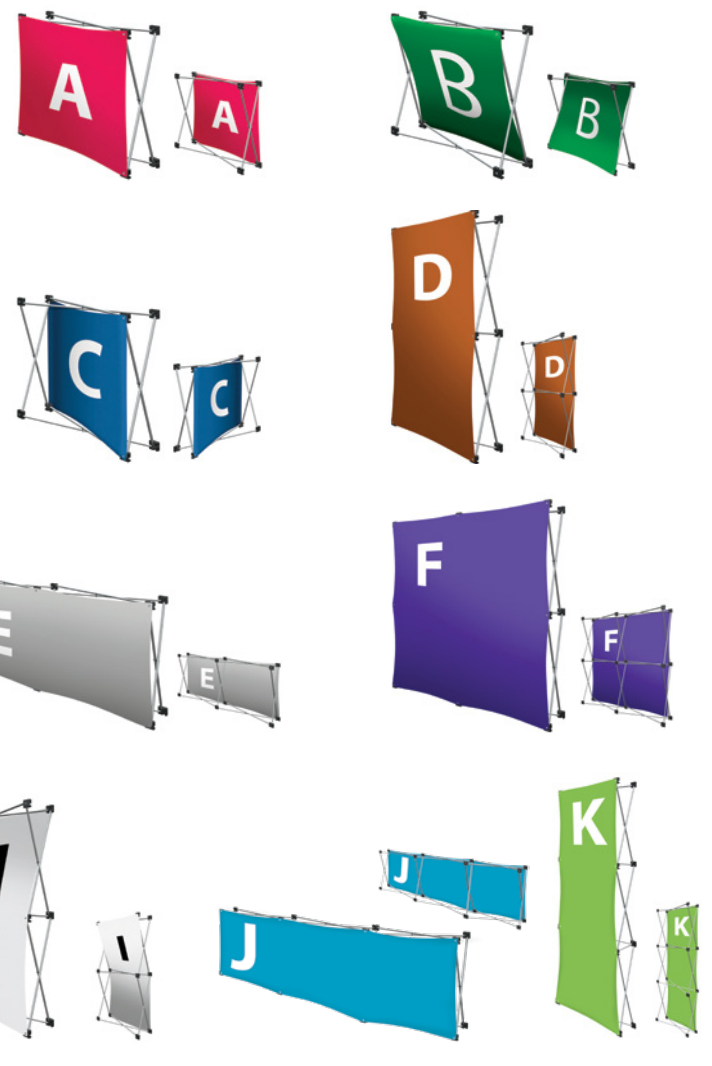

Graphic panels shown on partial frames for illustrative purposes only. Partial frames not available for purchase.

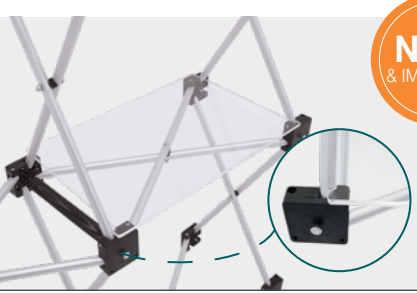

**NEW & IMPROVED**

Shelf design ensures a better fit for faster, easier installation.

### Add-Ons

#### Micro GeoMetrix Shelf

Item #	Description	1	2-5	6-11	12-24
338069	Internal Clear Shelf	50.45	48.45	46.43	44.41

Pricing is subject to change. USD MSRP (C)  
 Each shelf supports up to 5 lbs. Shelf size 14.5"W x 9.25"D.  
 Compatible with frames equipped with locking arms only.



**Ultimate LED Single or Double Light Kit**  
 Item #150120 & 150121  
 See page 287.

**HARDWARE-ONLY LEAD TIME: SHIPS SAME DAY WHEN ORDERED BEFORE 2 PM CENTRAL**

**PRICES ARE SUBJECT TO CHANGE.** No setup fee on orders placed via our website. Visit [showdowndisplays.com](http://showdowndisplays.com) for current pricing, graphic templates, product videos and assembly instructions. See pages 288-291 for order details.

SHOWDOWNDISPLAYS.COM · ASI 87188 · PPAI 254687 · SAGE 67383 · PPPC 20101202

production lead time after final proof approval  
**4 DAYS**



Joints are labeled for accurate step-by-step frame assembly.

3'W x 4'H and 3'W x 2'H kits on a 6' Standard throw shown in grape (sold separately; see page 12)

### EUROFIT TABLETOP STRAIGHT WALL



These six popular tabletop options feature everything you love about the EuroFit Straight Wall.

- Artwork is dye sublimated on recycled polyester knit
- 100% recycled media is made with fibers recycled from plastic bottles
- Fabric contours to the frame for a form-fitted look
- Lightweight aluminum frame
- Double-sided graphic cover slips over the frame like a pillowcase
- Push-button connectors make assembly a snap
- Floor display kits also available (see pages 232-233)

#### 2'H EuroFit Tabletop Straight Wall

Item #	Description	1	2-5	6-11	12-24
254620	2'W Kit	190.50	182.90	175.30	167.60
254623	3'W Kit	235.30	225.90	216.50	207.10
254626	6'W Kit	296.75	285.00	273.00	261.25

Setup fee: \$20(G)

Pricing is subject to change.

Kit Includes: Hardware, Graphic Cover, EuroFit Connector and Soft Carry Case

USD MSRP (C)

Description	Product Size	Finished Graphic Size	Product Wt.	Media
2'W	24.25"W x 25.375"H x 11.75"D	view online template	4.2 lbs.	recycled polyester knit
3'W	36.25"W x 25.375"H x 11.75"D	view online template	5 lbs.	recycled polyester knit
6'W	72.25"W x 25.375"H x 11.75"D	view online template	7 lbs.	recycled polyester knit

#### 4'H EuroFit Tabletop Straight Wall

Item #	Description	1	2-5	6-11	12-24
254603	2'W Kit	236.10	226.70	217.20	207.80
254606	3'W Kit	302.25	290.25	278.25	266.00
254615	6'W Kit	592.50	568.50	545.00	521.00

Setup fee: \$20(G)

Pricing is subject to change.

Kit Includes: Hardware, Graphic Cover, EuroFit Connector and Soft Carry Case

USD MSRP (C)

Description	Product Size	Finished Graphic Size	Product Wt.	Media
2'W	24.375"W x 49.5"H x 11.75"D	view online template	6.2 lbs.	recycled polyester knit
3'W	36.5"W x 49.5"H x 11.75"D	view online template	7.6 lbs.	recycled polyester knit
6'W	72.25"W x 49.5"H x 11.75"D	view online template	9.8 lbs.	recycled polyester knit



Hinge together multiple EuroFit displays with the included EuroFit Connector.

US Patent #9637963

production lead time after final proof approval

**4 DAYS**

**PRICES ARE SUBJECT TO CHANGE.** No setup fee on orders placed via our website.

Visit [showdowndisplays.com](http://showdowndisplays.com) for current pricing, graphic templates, product videos and assembly instructions. See pages 288-291 for order details.

SHOWDOWNDISPLAYS.COM · ASI 87188 · PPAI 254687 · SAGE 67383 · PPPC 20101202



## EUROFIT TRIFECTA



Maximize your tabletop space with the EuroFit Trifecta. This single display features three separate graphics, giving you more space to showcase your message on any 6-8' standard table.

- Three-panel design expands your message space with separate graphic areas
- Artwork is dye sublimated on recycled polyester knit; 100% recycled media is made with fibers recycled from plastic bottles
- Double-sided graphic covers slip over the frames like a pillowcase
- Fabric contours to the frame for a form-fitted look
- Aluminum frame features push-button connections
- Joints are labeled for step-by-step frame assembly



### EuroFit Trifecta

Item #	Description	1	2-5	6-11	12-24
254570	Kit	355.00	344.25	333.75	323.00

**Setup fee: \$20(G)** **Pricing is subject to change.**  
 Kit Includes: Hardware, Graphic Covers and Soft Carry Case USD MSRP (C)

Product Size	Finished Graphic Size	Product Wt.	Media
64.25"W x 24.75"H x 7"D	view online template	2.4 lbs.	recycled polyester knit



The two center feet contain two pole posts to connect your EuroFit frames together.



Center graphic cover has a curved top for a modern look.

## OVER-THE-TOP DISPLAY



Create an overhead banner or a stylish backdrop by simply clamping this display to a table.

- Artwork is dye sublimated on recycled polyester knit; 100% recycled media is made with fibers recycled from plastic bottles
- Double-sided cover is viewable from both the front and back of the display
- Lightweight, durable carbon composite poles with aluminum corners
- Use as a freestanding display by adding floor bases (sold separately)

### Over-The-Top Display

Item #	Description	1	2-5	6-11	12-24
280320	6' Header Kit	566.50	543.50	521.00	498.50
280321	8' Header Kit	590.00	566.50	543.00	519.50
280322	6' Short Back Wall Kit	594.50	570.50	547.00	523.00
280323	8' Short Back Wall Kit	636.00	610.50	585.00	559.50
280324	6' Tall Back Wall Kit	636.00	610.50	585.00	559.50
280325	8' Tall Back Wall Kit	664.50	638.00	611.00	584.50
280331	Floor Base with Pole Post (Set of 2)	130.10	124.90	119.70	114.50

**Setup fee: \$20(G)** **Pricing is subject to change.**  
 Kit Includes: Hardware, Graphic Cover and Soft Carry Case USD MSRP (C)

Description	Product Size	Finished Graphic Size	Product Wt.	Media
6' header	74.5"W x 44" or 68.25"H x 2.875"D	view online template	9.75 lbs.	recycled polyester knit
8' header	98"W x 44" or 68.25"H x 2.875"D	view online template	10 lbs.	recycled polyester knit
6' short back wall	74.5"W x 44"H x 2.875"D	view online template	11 lbs.	recycled polyester knit
8' short back wall	98"W x 44"H x 2.875"D	view online template	11.75 lbs.	recycled polyester knit
6' tall back wall	74.5"W x 68.25"H x 2.875"D	view online template	12 lbs.	recycled polyester knit
8' tall back wall	98"W x 68.25"H x 2.875"D	view online template	13.25 lbs.	recycled polyester knit



6' Header kit on a 6' UltraFit Curve throw (sold separately; see page 18)

**HARDWARE-ONLY LEAD TIME: SHIPS SAME DAY WHEN ORDERED BEFORE 2 PM CENTRAL**

**PRICES ARE SUBJECT TO CHANGE.** No setup fee on orders placed via our website. Visit [showdowndisplays.com](http://showdowndisplays.com) for current pricing, graphic templates, product videos and assembly instructions. See pages 288-291 for order details.

SHOWDOWNDISPLAYS.COM · ASI 87188 · PPAI 254687 · SAGE 67383 · PPPC 20101202

production lead time after final proof approval  
**4 DAYS**

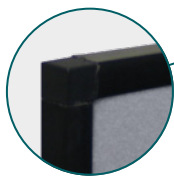

Plastic frame has square corners.



6' display with full graphics on a 6' Standard throw shown in mulberry (sold separately; see page 12)

Fabric Colors

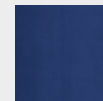

Blue PMS 287

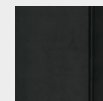

Black

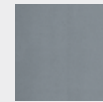

Gray PMS 430

FAST TRAK DISPLAY



Create an eye-catching presentation with this popular, lightweight display.

- Display can be used with graphic panels on both sides
- Hook-and-loop receptive fabric makes graphic panel changes quick and easy
- Seamless design with hidden double-acting hinges
- Available in 4' or 6' sizes
- Easy clip-on header

Fast Trak Display

Item #	Description	1	2-5	6-11	12-24
146084	4' Display Only	444.75	427.00	409.00	391.25
146011	4' Display with Header Graphic Panel	528.50	507.50	486.25	465.25
146012	4' Display with Full Graphic Panels	872.50	820.50	777.00	733.50
146085	6' Display Only	496.50	476.75	457.00	437.00
146014	6' Display with Header Graphic Panel	596.00	572.00	548.50	524.50
146015	6' Display with Full Graphic Panels	1049.00	984.50	931.50	878.50

Setup fee: \$20(G)

Pricing is subject to change.

USD MSRP (C)

Description	Product Size	Finished Graphic Size	Product Wt.	Media
4'	54"W x 37"H x 22"D	view online template	10 lbs.	Titan™ no-curl laminated media
6'	72"W x 48"H x 22"D	view online template	15 lbs.	Titan™ no-curl laminated media

Graphic Panels

Item #	Description	1	2-5	6-11	12-24
190015	4' Header Graphic Panel	83.95	80.60	77.20	73.85
190013	6' Header Graphic Panel	99.30	95.35	91.35	87.40
190017	4' Body Graphic Panel	114.70	110.10	105.50	100.90
190014	6' Body Graphic Panel	150.90	144.80	138.80	132.80

Setup fee: \$20(G)

Pricing is subject to change.

USD MSRP (C)

Display Options



Display Only Includes:

- Display (No Graphic Panels)
- Soft Carry Case



Display with Header Graphic Panel Includes:

- Display
- Header Graphic Panel
- Soft Carry Case



Display with Full Graphic Panels Includes:

- Display
- Header Graphic Panel
- 3 Body Graphic Panels
- Soft Carry Case

production lead time after final proof approval

3 DAYS

DISPLAY-ONLY (NO GRAPHICS) LEAD TIME: SHIPS SAME DAY WHEN ORDERED BEFORE 2 PM CENTRAL

PRICES ARE SUBJECT TO CHANGE. No setup fee on orders placed via our website.

Visit [showdowndisplays.com](http://showdowndisplays.com) for current pricing, graphic templates, product videos and assembly instructions. See pages 288-291 for order details.

SHOWDOWNDISPLAYS.COM · ASI 87188 · PPAI 254687 · SAGE 67383 · PPPC 20101202

Fabric Colors

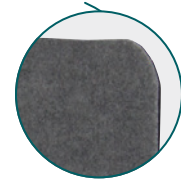
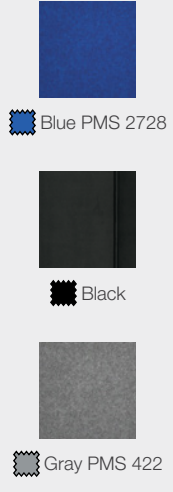

Frameless display has rounded corners.

6' display with graphic panels on a 6' Standard throw shown in navy blue (sold separately; see page 12)

DYNAMO TRIFECTA DISPLAY



Lightweight and affordable, this display is perfect for the budget-conscious marketer.

- Double-acting fabric hinges
- Hook-and-loop receptive fabric makes graphic panel changes quick and easy
- Available in 4' or 6' sizes
- Easy to fold for transportation and storage
- Includes soft carry case

Dynamo Trifecta Display

Item #	Description	1	2-5	6-11	12-24
141007	4' Display Only	218.10	209.40	200.60	191.90
141009	4' Display with Graphic Panels	504.00	483.50	462.75	442.25
141008	6' Display Only	250.25	240.30	230.30	220.30
141010	6' Display with Graphic Panels	685.00	656.50	628.50	600.50

Setup fee: \$20(G) Pricing is subject to change. USD MSRP (C)

Description	Product Size	Finished Graphic Size	Product Wt.	Media
4'	54"W x 24"H x 22"D	view online template	5 lbs.	Titan™ no-curl laminated media
6'	72"W x 36"H x 22"D	view online template	10 lbs.	Titan™ no-curl laminated media

Graphic Panels

Item #	Description	1	2-5	6-11	12-24
190023	4' Body Graphic Panel	99.30	95.35	91.35	87.40
190014	6' Body Graphic Panel	150.90	144.80	138.80	132.80

Setup fee: \$20(G) Pricing is subject to change. USD MSRP (C)



DISPLAY-ONLY (NO GRAPHICS) LEAD TIME: SHIPS SAME DAY WHEN ORDERED BEFORE 2 PM CENTRAL

PRICES ARE SUBJECT TO CHANGE. No setup fee on orders placed via our website. Visit showdowndisplays.com for current pricing, graphic templates, product videos and assembly instructions. See pages 288-291 for order details.

SHOWDOWNDISPLAYS.COM · ASI 87188 · PPAI 254687 · SAGE 67383 · PPPC 20101202

production lead time after final proof approval  
**3 DAYS**



18" Economy



24" LiteWay Economy



Deluxe Mini



Small Mini Promo



Large Mini Promo

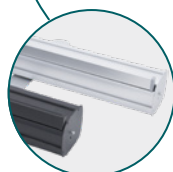

Economy hardware available in silver or black.

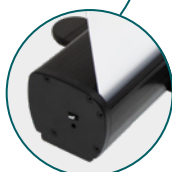

Hardware is made from durable PVC.



Flip-open base discretely hides the pole and banner when not in use.

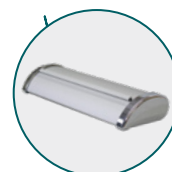

Lightweight aluminum base has a small footprint.

## MINI RETRACTORS



These mini retractors can be used even when space is limited.

- Compact size
- Lightweight and portable
- Warranties range between six months and one year (see Retractable Banner Comparison Chart on page 27 for details)

### Economy Tabletop Retractor

Item #	Description	1	2-5	6-11	12-24
261380	18" No-Curl Hybrid Media Kit	147.20	141.30	134.00	126.60
261381	18" No-Curl Opaque Fabric Kit	147.20	141.30	134.00	126.60
261382	18" PVC-Free Silver Backed Media Kit	147.20	141.30	134.00	126.60
261430	18" Dry-Erase Media Kit	147.20	141.30	134.00	126.60
261130	24" No-Curl Hybrid Media Kit	180.20	173.00	164.00	155.00
262160	24" No-Curl Opaque Fabric Kit	180.20	173.00	164.00	155.00
261360	24" PVC-Free Silver Backed Media Kit	180.20	173.00	164.00	155.00
261431	24" Dry-Erase Media Kit	180.20	173.00	164.00	155.00

**Setup fee: \$20(G)** **Pricing is subject to change.**  
Kit Includes: Silver or Black Hardware, Installed Graphic and Soft Carry Case USD MSRP (C)

Description	Product Size	Finished Graphic Size	Product Wt.	Media
deluxe mini	9.375"W x 17.75"H x 4"D	view online template	1.5 lbs.	Titan™ polypropylene media
small mini	9.625"W x 13.25"H x 3"D	view online template	1 lb.	Titan™ polypropylene media
large mini	13.125"W x 17.875"H x 3"D	view online template	1 lb.	Titan™ polypropylene media
18" economy	19"W x 28"H x 11"D	view online template	5.4 lbs.	see kit description
24" economy	24.75"W x 39"H x 11"D	view online template	5.5 lbs.	see kit description
liteway	24.75"W x 39"H x 11"D	view online template	5.8 lbs.	Titan™ no-curl hybrid media

### LiteWay Economy Tabletop Retractor

Item #	Description	1	2-5	6-11	12-24
261434	Kit	120.00	112.80	108.00	100.80

**Setup fee: \$20(G)** **Pricing is subject to change.**  
Kit Includes: Black Hardware, Installed Graphic and Soft Carry Case USD MSRP (C)

### Mini Promo Retractor

Item #	Description	1	2-5	6-11	12-24
210240	Small Kit	65.00	62.40	59.80	57.20
210242	Large Kit	72.65	69.75	66.85	63.95

**Setup fee: \$20(G)** **Pricing is subject to change.**  
Kit Includes: Hardware and Installed Graphic USD MSRP (C)

### Deluxe Mini Retractor

Item #	Description	1	2-5	6-11	12-24
262014	Kit	83.95	80.60	77.20	73.85

**Setup fee: \$20(G)** **Pricing is subject to change.**  
Kit Includes: Hardware and Installed Graphic USD MSRP (C)

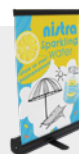

#### Dry-Erase Media

Dry-erase media, available for the Economy Tabletop Retractor, is both fun and functional. It features a glossy surface that has the write-on/wipe-off utility of a dry-erase board (dry-erase markers not included).

production lead time after final proof approval

**2DAYS**

**PRICES ARE SUBJECT TO CHANGE.** No setup fee on orders placed via our website.

Visit [showdowndisplays.com](http://showdowndisplays.com) for current pricing, graphic templates, product videos and assembly instructions. See pages 288-291 for order details.

SHOWDOWNDISPLAYS.COM · ASI 87188 · PPAI 254687 · SAGE 67383 · PPPC 20101202

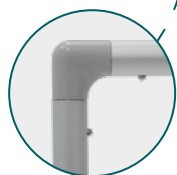

Aluminum frame features push-button connections and square plastic corners.



Base available with 1, 2 or 3 holes (4" x 6" Stick Flags sold separately; see page 77).



Double-sided flags feature a lightweight block-out polyester.

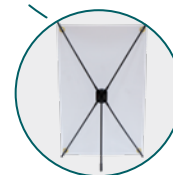

X-shaped frame features four tension rods that keep the banner taut.

## MINI DISPLAYS



These displays fit into small areas, making them perfect for tables and countertops.

- Lightweight and portable
- Warranties range between 6 months and one year (see website for details)

### EuroFit Mini Display

Item #	Description	1	2-5	6-11	12-24
280370	Kit	109.00	104.60	100.30	95.90

Setup fee: \$20(G) Pricing is subject to change.

Kit Includes: Hardware, Graphic Cover and Soft Carry Case USD MSRP (C)

### Micro Teardrop Sail Sign

Item #	Description	1	5	6-11	12-24
191540	Single-Sided Kit	NA	58.20	55.20	53.40
191541	Double-Sided Kit	NA	93.45	88.60	85.75

Setup fee: \$20(G) Pricing is subject to change.

Kit Includes: Hardware, Graphic and Carry Pouch USD MSRP (C)

### Mini X Banner Display

Item #	Description	1	2-5	6-11	12-24
210032	Kit	41.80	40.13	38.46	36.78

Setup fee: \$20(G) Pricing is subject to change.

Kit Includes: Hardware, Graphic and Drawstring Pouch USD MSRP (C)

### Stick Flag Base

Item #	Description	1	2-5	6-11	12-24
304757	Base for One 4" x 6" Stick Flag	2.59	2.38	2.23	2.07
304758	Base for Two 4" x 6" Stick Flags	3.68	3.39	3.16	2.94
304759	Base for Three 4" x 6" Stick Flags	3.68	3.39	3.16	2.94

Pricing is subject to change. USD MSRP (C)

Base only. Stick Flags sold separately (see page 77).

Description	Product Size	Finished Graphic Size	Product Wt.	Media
stick flag base	2.5"W x 1"H x 2.5"D	NA	0.25 lb.	NA
EuroFit mini	12.875"W x 18.625"H x 11"D	view online template	2.25 lbs.	recycled polyester knit
micro teardrop	9"W x 17.5"H x 3.125"D	view online template	3.9 oz.	see website
mini x	11.75"W x 18"H x 10.75"D	view online template	0.5 lb.	Titan™ no-curl laminated media

**HARDWARE-ONLY LEAD TIME: SHIPS SAME DAY WHEN ORDERED BEFORE 2 PM CENTRAL**  
**PRICES ARE SUBJECT TO CHANGE.** No setup fee on orders placed via our website.  
 Visit [showdowndisplays.com](http://showdowndisplays.com) for current pricing, graphic templates, product videos and assembly instructions. See pages 288-291 for order details.  
 SHOWDOWNDISPLAYS.COM · ASI 87188 · PPAI 254687 · SAGE 67383 · PPPC 20101202

MINI X production lead time after final proof approval  
**24 DAYS** 257



# STANDS & FURNITURE

1. Sports Chair page 277 2. ShowGlower Totem page 264 3. CounterPop page 259 4. Presto Easel page 279 5. Party Table page 266

## have you considered...

- **size** what is the size of your space?
- **frequency** how often will you be setting up and taking down your stand or furniture?
- **transport** how will this item be transported?
- **lighting** will you require the product to be illuminated in the space?
- **power** will power be available?

## how to **DISPLAY**

Provide a polished and organized space for product displays, literature, and promotional materials with our wide selection of counters, chairs and more! Improve brand visibility and enhance engagement across your displays. Great for any event!

## COUNTERPOP



Combining the features of a counter and a pop-up display, the CounterPop is truly a multifunctional display.

- Available in three widths
- Artwork is dye sublimated on recycled polyester knit
- 100% recycled media is made with fibers recycled from plastic bottles
- Hook-and-loop fasteners make it easy to install graphic panels
- Countertop supports up to 30 lbs.; internal shelves support up to 10 lbs.



MDF countertop and internal shelf with woodgrain laminate.



Countertop folds in half for convenient storage.

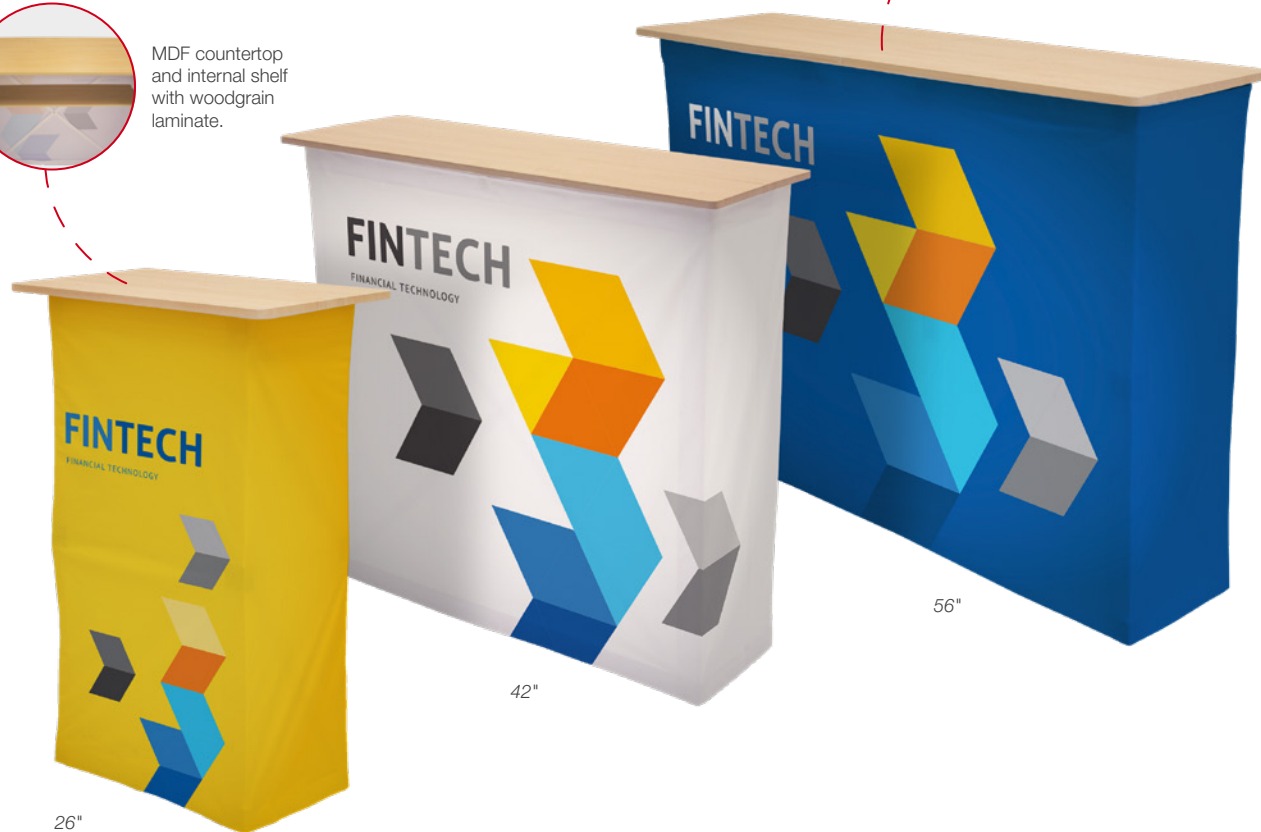

### CounterPop

Item #	Description	1	2-5	6-11	12-24
256800	26" Kit	604.00	586.00	567.50	549.50
257055	42" Kit	697.00	676.00	655.50	634.50
256803	56" Kit	781.50	758.00	734.50	711.00

Setup fee: \$20(G)

Pricing is subject to change.

Kit Includes: Hardware, Graphic Panel and Soft Carry Case

USD MSRP (C)

Description	Product Size	Finished Graphic Size	Product Wt.	Media
26"	26"W x 40"H x 15.75"D	view online template	17 lbs.	recycled polyester knit
42"	41.75"W x 40"H x 15.75"D	view online template	22.25 lbs.	recycled polyester knit
56"	55.875"W x 40"H x 15.75"D	view online template	28 lbs.	recycled polyester knit



**PRICES ARE SUBJECT TO CHANGE.** No setup fee on orders placed via our website. Visit [showdowndisplays.com](http://showdowndisplays.com) for current pricing, graphic templates, product videos and assembly instructions. See pages 288-291 for order details. SHOWDOWNDISPLAYS.COM · ASI 87188 · PPAI 254687 · SAGE 67383 · PPPC 20101202

production lead time after final proof approval  
**4 DAYS**



Rectangle

Oval

Black MDF countertop.

## IMPRESS COUNTERS



These easy-to-assemble counters feature your full-color artwork on the outside and storage space on the inside.

- SEG for easy graphic panel installation
- Artwork is dye sublimated on two-way stretch fabric
- Countertop supports up to 20 lbs.

### Impress Oval Counter

Item #	Description	1	2-5	6-11	12-24
257044	Kit	541.50	525.00	509.00	492.75

Setup fee: \$20(G)

Pricing is subject to change.

Kit Includes: Hardware, Graphic Panel and Soft Carry Case

USD MSRP (C)

Product Size	Finished Graphic Size	Product Wt.	Media
23.375"W x 39.75"H x 15.5"D	view online template	16 lbs.	two-way stretch fabric

### Impress Rectangle Counter

Item #	Description	1	2-5	6-11	12-24
257047	Kit	624.50	606.00	587.50	568.50

Setup fee: \$20(G)

Pricing is subject to change.

Kit Includes: Hardware, Graphic Panel and Soft Carry Case

USD MSRP (C)

Product Size	Finished Graphic Size	Product Wt.	Media
31.5"W x 39.75"H x 20.875"D	view online template	23.5 lbs.	two-way stretch fabric

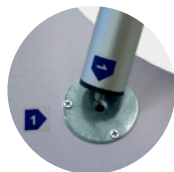

Threaded poles twist together for easy setup.



With a quick press of your thumb, the fabric's gasket edges are pushed into a narrow channel built into the countertop and base.



Zippered back creates an enclosed storage area.



Rubber feet for stability.



Hard case allows for storage when in use and during transport.



Use the space inside the counter for storage.



## TRANSPORT CASE-TO-COUNTER



The ultimate solution for all your transport and display needs. This hard case seamlessly transforms into a stylish counter display.

- Dye-sublimated wrap slides on for easy setup
- Durable, roto-molded case
- Wheeled case for easy transport
- Countertop supports up to 20 lbs.

### Transport Case-to-Counter

Item #	Description	1	2-5	6-11	12-24
257037	Kit	779.00	755.50	732.50	709.00
257038	Hard Case w/ Wheels Only	540.50	524.50	508.00	492.00

Setup fee: \$20(G)

Pricing is subject to change.

Kit Includes: Hard Case with Wheels and Graphic Wrap

USD MSRP (C)

Product Size	Finished Graphic Size	Product Wt.	Media
38"W x 37.625"H x 20.5"D	view online template	26 lbs.	two-way stretch fabric

production lead time after final proof approval

**4 DAYS**

**HARDWARE-ONLY LEAD TIME: SHIPS SAME DAY WHEN ORDERED BEFORE 2 PM CENTRAL**

**PRICES ARE SUBJECT TO CHANGE.** No setup fee on orders placed via our website.

Visit [showdowndisplays.com](http://showdowndisplays.com) for current pricing, graphic templates, product videos and assembly instructions. See pages 288-291 for order details.

SHOWDOWNDISPLAYS.COM · ASI 87188 · PPAI 254687 · SAGE 67383 · PPPC 20101202

## PROMO COUNTER



This portable counter delivers streamlined setup and professional presentation.

- Features a wooden black countertop
- Artwork is vibrantly printed on durable Titan 13 oz. scrim vinyl; attaches via hook-and-loop
- Keep your graphic attached to the support panel and roll it up for quick packing into the included padded soft carry case
- Countertop supports up to 30 lbs.

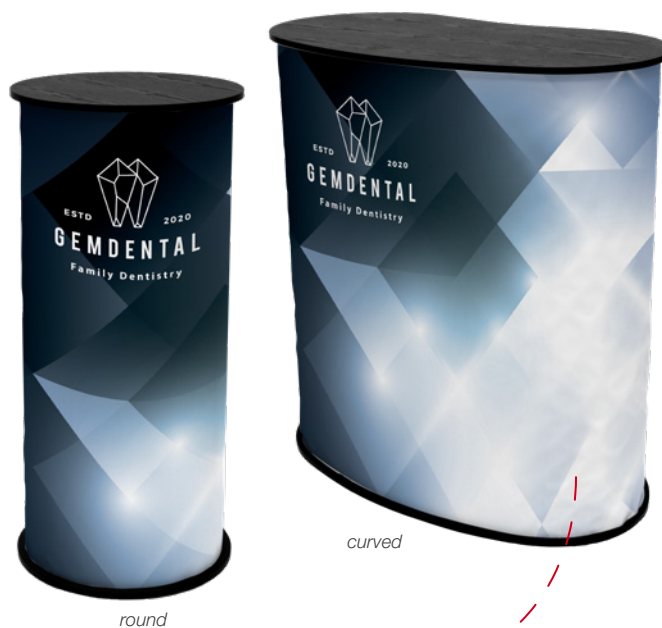

### Promo Counter

Item #	Description	1	2-5	6-11	12-24
257010	Round Kit	395.00	383.25	371.25	359.50
257013	Curved Kit	490.00	475.25	460.50	446.00

Setup fee: \$20(G)

Pricing is subject to change.

Kit Includes: Hardware, Graphic Panel and Soft Carry Case

USD MSRP (C)

Description	Product Size	Finished Graphic Size	Product Wt.	Media
round	17.75"W x 36.75"H x 17.75"D	view online template	14.8 lbs.	Titan™ 13 oz. scrim vinyl
curved	35.5"W x 36.75"H x 20"D	view online template	25.5 lbs.	Titan™ 13 oz. scrim vinyl

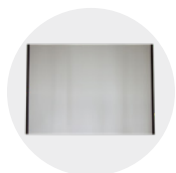

Flexible support panel attaches securely to base with hook-and-loop for effortless setup.



Artwork attaches easily via hook-and-loop to the flexible support panel.

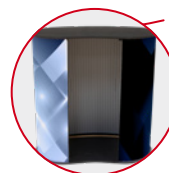

Curved counter features an open back, perfect for storage space.

## EXHIBITION COUNTER



From transport to tradeshow ready in minutes. This versatile counter combines durability, storage and brand presence in one smart solution.

- Constructed from durable plastic
- Countertops and shelves are constructed of durable MDF
- Countertop supports up to 50 lbs.; shelves support up to 10 lbs. each
- Graphic panel is vibrantly printed on Titan™ 13 oz scrim vinyl
- All components pack neatly into the case with extra space for tradeshow essentials
- Soft protective sleeve included to protect hardware and shelves



### Exhibition Counter

Item #	Description	1	2-5	6-11	12-24
257120	Kit	1160.00	1125.00	1090.00	1056.00
257121	XL Kit	2462.00	2435.00	2311.00	2284.00

Setup fee: \$20(G)

Pricing is subject to change.

Kit Includes: Hard Case with Wheels and Graphic Panel

USD MSRP (C)

XL Kit Includes: 2 Hard Cases with Wheels and Graphic Panel

Description	Product Size	Finished Graphic Size	Product Wt.	Media
kit	49"W x 37.875"H x 24"D	view online template	75.5 lbs.	Titan™ 13 oz. scrim vinyl
XL kit	86"W x 37.875"H x 35"D	view online template	176 lbs.	Titan™ 13 oz. scrim vinyl



Secure countertop with latches.



Each case features two built-in wheels for easy transport.



Graphic attaches to case via hook-and-loop.



Each case includes four removable interior shelves.

PRICES ARE SUBJECT TO CHANGE. No setup fee on orders placed via our website. Visit [showdowndisplays.com](http://showdowndisplays.com) for current pricing, graphic templates, product videos and assembly instructions. See pages 288-291 for order details.

SHOWDOWNDISPLAYS.COM · ASI 87188 · PPAI 254687 · SAGE 67383 · PPPC 20101202

production lead time after final proof approval  
**3 DAYS**



Push counter down with graphic on for easy transport.

Collapses down to just 4" high.



## COLLAPSIBLE COUNTER



Transform your presentations and demonstrations with this portable counter that sets up in seconds, providing a stylish and professional display tool.

- Artwork is dye sublimated on recycled polyester knit
- 100% recycled media is made with fibers recycled from plastic bottles
- SEG for easy graphic panel installation
- Graphic can stay attached to hardware in between uses
- Black MDF countertop supports up to 20 lbs.

### Collapsible Counter

Item #	Description	1	2-5	6-11	12-24
257150	Kit	551.00	534.50	518.00	501.50

Setup fee: \$20(G)

Pricing is subject to change.

Kit Includes: Hardware, Graphic Panel and Soft Carry Case

USD MSRP (C)

Product Size	Finished Graphic Size	Product Wt.	Media
38.75"W x 39.625"H x 15"D	view online template	26.2 lbs.	recycled polyester knit



Spring-loaded push assembly; push-down to collapse.



## COLLAPSIBLE LIT COUNTER



This eye-catching, and portable LED light-up counter, sets up in seconds, and is designed for maximum impact and convenience.

- Spring-loaded push assembly; push-down to collapse
- Artwork is dye sublimated on backlit woven polyester
- SEG for easy graphic panel installation
- LED lights are embedded in the base
- Graphic can stay attached to hardware in between uses
- Black MDF countertop supports up to 20 lbs.

### Collapsible Lit Counter

Item #	Description	1	2-5	6-11	12-24
257153	Kit	842.50	817.50	792.00	767.00

Setup fee: \$20(G)

Pricing is subject to change.

Kit Includes: Hardware, Graphic Panel and Soft Carry Case

USD MSRP (C)

Product Size	Finished Graphic Size	Product Wt.	Media
38.75"W x 39.625"H x 15"D	view online template	26.6 lbs.	backlit woven polyester



LED lights on the bottom of the frame create a glow effect.

production lead time after final proof approval

**4 DAYS**

**PRICES ARE SUBJECT TO CHANGE.** No setup fee on orders placed via our website. Visit [showdowndisplays.com](http://showdowndisplays.com) for current pricing, graphic templates, product videos and assembly instructions. See pages 288-291 for order details.

SHOWDOWNDISPLAYS.COM · ASI 87188 · PPAI 254687 · SAGE 67383 · PPPC 20101202

## SHOWGOER CASE-TO-PODIUM



Take your display on the go. This podium converts into a wheeled case for simple, worry-free transportation.

- Dye-sublimated wrap slides on for easy setup
- Durable, roto-molded case
- Removable top and built-in tray for quick access to your show materials
- Countertop supports up to 20 lbs.

### ShowGoer Case-to-Podium

Item #	Description	1	2-5	6-11	12-24
257030	Kit	759.50	737.00	714.00	691.00
257031	Hard Case w/ Wheels Only	469.75	455.75	441.50	427.50

Setup fee: \$20(G)

Pricing is subject to change.

Kit Includes: Hard Case with Wheels and Graphic Wrap USD MSRP (C)

Product Size	Finished Graphic Size	Product Wt.	Media
38.375"W x 34.875"H x 16.875"D	view online template	27.5 lbs.	two-way stretch fabric



Wheels and pull-up handle make transport easy.



Stunning on the show floor, convenient in storage.

## SHOWGLOWER PODIUM



Shine some light on your message or brand with this backlit podium.

- The MDF tabletop offers a great deal of usable surface
- SEG for easy graphic panel installation
- Artwork is dye sublimated on backlit woven polyester
- Countertop supports up to 30 lbs.

### ShowGlower Podium

Item #	Description	1	2-5	6-11	12-24
257064	Kit	974.00	944.50	915.50	886.00

Setup fee: \$20(G)

Pricing is subject to change.

Kit Includes: Hardware, Graphic Panel and Soft Carry Case USD MSRP (C)

Product Size	Finished Graphic Size	Product Wt.	Media
31.5"W x 39.75"H x 20.875"D	view online template	29.5 lbs.	backlit woven polyester



Joints are labeled for step-by-step assembly.



With a quick press of your thumb, the fabric's gasket edges are pushed into a narrow channel built into the countertop and base.



LED lights are embedded in the display base to create a glow effect.

**HARDWARE-ONLY LEAD TIME: SHIPS SAME DAY WHEN ORDERED BEFORE 2 PM CENTRAL**  
**PRICES ARE SUBJECT TO CHANGE.** No setup fee on orders placed via our website.  
 Visit [showdowndisplays.com](http://showdowndisplays.com) for current pricing, graphic templates, product videos and assembly instructions. See pages 288-291 for order details.  
 SHOWDOWNDISPLAYS.COM · ASI 87188 · PPAI 254687 · SAGE 67383 · PPPC 20101202

production lead time  
after final proof approval  
**4 DAYS**



## SHOWGLOWER COUNTER



### Light up your brand with this glowing counter unit.

- Available in two display options: graphic panels on both the front and back, or graphic panel on the front with a block-out panel on the back
- Artwork is dye sublimated on backlit woven polyester
- SEG for easy graphic panel installation
- Lightweight aluminum frame
- With a quick press of your thumb, the fabric's gasket edges are pushed into narrow channels built into the front and back of the frame
- LED lights are embedded in the display frame for a soft glow
- Countertop supports up to 20 lbs.

### ShowGlower Counter

Item #	Description	1	2-5	6-11	12-24
257140	Kit	856.50	831.00	805.00	779.50

Setup fee: \$20(G)

Pricing is subject to change.

Kit Includes: Hardware, 2 Graphic Panels, 4 No-Gap Connectors and Soft Carry Case USD MSRP (C)

### ShowGlower Counter with Block-Out Back Panel

Item #	Description	1	2-5	6-11	12-24
257141	Kit	974.50	945.00	916.00	886.50

Setup fee: \$20(G)

Pricing is subject to change.

Kit Includes: Hardware, Graphic Panel, Block-Out Back Panel, 4 No-Gap Connectors and Soft Carry Case USD MSRP (C)

Product Size	Finished Graphic Size	Product Wt.	Media
39.375"W x 40.5"H x 15.75"D	view online template	25.4 lbs.	backlit woven polyester



LED lights on the top and bottom of the frame create a glow effect.



The MDF countertop offers a great deal of usable surface.



84"



44"

44" Totem can be displayed with or without the tabletop attachment.



Collapses flat as a single piece for simple, fast teardown.



Clips built into the frame let you lock it in place.

## SHOWGLOWER TOTEM & TOTEM TABLE



### This bright tower offers an eye-catching appearance with a small footprint.

- Easy setup: Pull it up and clip it together in seconds
- Artwork is dye sublimated on backlit woven polyester
- SEG for easy graphic panel installation
- LED lights in the display create a soft glow
- Tabletop supports up to 10 lbs.
- Soft carry case not included

### ShowGlower Totem

Item #	Description	1	2-5	6-11	12-24
254905	44"H Kit	990.00	960.00	930.50	900.50
254913	84"H Kit	1582.00	1535.00	1488.00	1440.00

Setup fee: \$20(G)

Pricing is subject to change.

Kit Includes: Hardware and Graphic Panel USD MSRP (C)

Description	Product Size	Finished Graphic Size	Product Wt.	Media
44"	15.625"W x 43.25"H x 15.625"D	view online template	13.8 lbs.	backlit woven polyester
84"	15.625"W x 82.5"H x 15.625"D	view online template	21.8 lbs.	backlit woven polyester

### ShowGlower Totem Table

Item #	Description	1	2-5	6-11	12-24
254908	44"H Table Kit	1215.00	1178.00	1142.00	1105.00

Setup fee: \$20(G)

Pricing is subject to change.

Kit Includes: Hardware, Tabletop and Graphic Panel USD MSRP (C)

Product Size	Finished Graphic Size	Product Wt.	Media
22.625"W x 43.25"H x 22.625"D	view online template	19 lbs.	backlit woven polyester

production lead time after final proof approval

**4 DAYS**

**PRICES ARE SUBJECT TO CHANGE.** No setup fee on orders placed via our website.

Visit [showdowndisplays.com](http://showdowndisplays.com) for current pricing, graphic templates, product videos and assembly instructions. See pages 288-291 for order details.

SHOWDOWNDISPLAYS.COM · ASI 87188 · PPAI 254687 · SAGE 67383 · PPPC 20101202



Complete your display by pairing a Pop-Up Table with a tent (sold separately).

## POP-UP TABLE



The Pop-Up Table is designed for easy portability and compact storage. Its durable construction makes it suitable for use in any setting.

- Sold as table only or kitted with a fitted table cover
- Available in 77.5"W or 115"W
- Features 4 height settings: kitted throws available for 32"H and 38.5"H for sitting or standing behind
- 1.75" diameter hexagon-shaped legs constructed of 0.8 mm anodized aluminum
- Artwork is dye sublimated on 600 denier polyester
- Throw is machine-washable and flame retardant certified for exhibit hall use



Table collapses to fit inside included soft carry case.

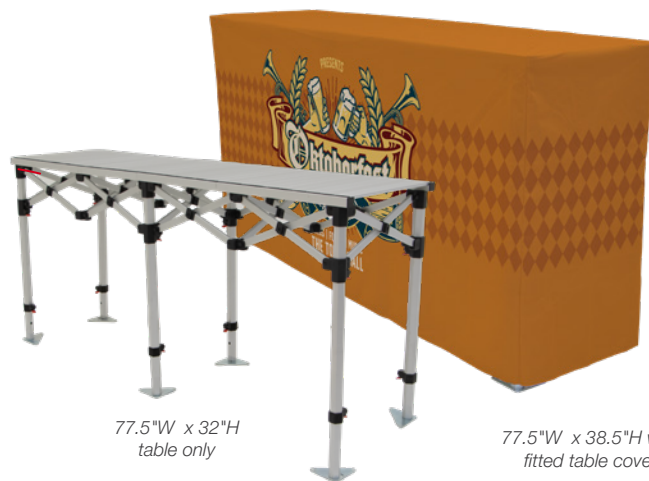

77.5"W x 32"H table only

77.5"W x 38.5"H with fitted table cover

### 77.5"W Pop-Up Table

Item #	Description	1	2-5	6-11	12-24
241440	32"H Kit	708.50	687.00	666.00	644.50
241441	38.5"H Kit	735.00	713.00	691.00	669.00
241442	Pop-Up Table Only	364.00	353.00	342.25	331.25

Setup fee: \$20(G)

Pricing is subject to change.

Kit Includes: Table Hardware, Table Throw and Soft Carry Case

USD MSRP (C)

Description	Product Size	Finished Graphic Size	Product Wt.	Media
32"H	77.625"W x 32"H x 21.25"D	view online template	41.3 lbs.	600 denier polyester
38.5"H	77.625"W x 38.375"H x 21.25"D	view online template	41.8 lbs.	600 denier polyester
table only	77.625"W x 28.125"-38.375"H x 21.25"D	NA	37.8 lbs.	NA

### 115"W Pop-Up Table

Item #	Description	1	2-5	6-11	12-24
241445	32"H Kit	873.50	847.50	821.00	795.00
241446	38.5"H Kit	900.00	873.00	846.00	819.00
241447	Pop-Up Table Only	476.00	461.75	447.50	433.25

Setup fee: \$20(G)

Pricing is subject to change.

Kit Includes: Table Hardware, Table Throw and Soft Carry Case

USD MSRP (C)

Description	Product Size	Finished Graphic Size	Product Wt.	Media
32"H	115"W x 32"H x 21.25"D	view online template	54.8 lbs.	600 denier polyester
38.5"H	115"W x 38.375"H x 21.25"D	view online template	55.5 lbs.	600 denier polyester
table only	115"W x 28.125"-38.375"H x 21.25"D	NA	50 lbs.	NA



115"W x 38.5"H with fitted table cover

115"W x 32"H with fitted table cover



Unroll tabletop on top of frame for quick and easy installation.



Triangular feet provide stability on any surface.



77.5"W table supports up to 100 lbs.; 115"W table supports up to 150 lbs.



Legs feature levers for easy height adjustments.

HARDWARE-ONLY LEAD TIME: SHIPS SAME DAY WHEN ORDERED BEFORE 2 PM CENTRAL

PRICES ARE SUBJECT TO CHANGE. No setup fee on orders placed via our website.

Visit [showdowndisplays.com](http://showdowndisplays.com) for current pricing, graphic templates, product videos and assembly instructions. See pages 288-291 for order details.

SHOWDOWNDISPLAYS.COM · ASI 87188 · PPAI 254687 · SAGE 67383 · PPPC 20101202

production lead time after final proof approval

**3 DAYS**



Shown in indigo



Stadium Table Plus has an imprinted carry case.

**Stock Stadium Table Colors**

- Crimson PMS 186
- Indigo PMS 295
- Black

*PMS colors are for reference only and may vary slightly from actual color.*

**STADIUM TABLE**



**Make every gathering easier with a table set designed for tailgating, beach or backyard.**

- Includes table and four stools
- Table supports up to 45 lbs.; stool support up to 220 lbs. each
- Frame is constructed with steel
- Artwork is printed on polyester
- Features four built-in cupholders
- Built-in umbrella holder (umbrella not included)
- Folds to fit inside soft case

**Stadium Table**

Item #	Description	1	2-5	6-11	12-24
AT0022	Kit	102.90	100.20	98.15	95.95

**Setup fee: \$20(G)** **Pricing is subject to change.**  
 Kit Includes: Imprinted Table, 4 Stools and Soft Carry Case USD MSRP (C)

**Stadium Table Plus**

Item #	Description	1	2-5	6-11	12-24
AT0023	Kit	106.50	103.70	101.70	99.35

**Setup fee: \$20(G)** **Pricing is subject to change.**  
 Kit Includes: Imprinted Table, 4 Stools and Imprinted Soft Carry Case USD MSRP (C)

Product Size	Finished Graphic Size	Product Wt.
28.5"W x 24"-36"H x 28.5"D	view online template	18 lbs.



**PARTY TABLE**



**From tailgates to tastings, this 8' party table is your go-to for any gathering.**

- Table supports up to 66 lbs.
- Includes six ping pong balls
- Frame is constructed with aluminum
- Vibrant full-color decal applied to each tabletop section
- Decals are permanent and cannot be swapped or repositioned

**Party Table**

Item #	Description	1	2-5	6-11	12-24
AT0011	Kit	211.00	205.50	201.40	196.90

**Setup fee: \$20(G)** **Pricing is subject to change.**  
 Kit Includes: Decaled Table and 6 Ping Pong Balls USD MSRP (C)

Product Size	Finished Graphic Size	Product Wt.	Media
24"W x 38"H x 94"D	view online template	21 lbs.	decal vinyl film



Folds down for easy transport.

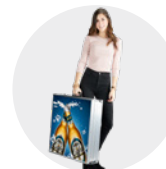

When folded, handles are accessible for carrying the table.

production lead time after final proof approval  
**7 DAYS**

**PRICES ARE SUBJECT TO CHANGE.** No setup fee on orders placed via our website.

Visit [showdowndisplays.com](http://showdowndisplays.com) for current pricing, graphic templates, product videos and assembly instructions. See pages 288-291 for order details.

SHOWDOWNDISPLAYS.COM · ASI 87188 · PPAI 254687 · SAGE 67383 · PPPC 20101202

## BISTRO TABLE SET



Bring café vibes to any setting with this sleek, heavy-duty bistro table and chair set.

- Includes two chairs and a table
- Frame is constructed with steel; tabletop, chair back and seat are plastic
- Vibrant full-color decals
- Decals are permanent and cannot be swapped or repositioned
- Table and chairs fold for easy transport



### Bistro Table Set

Item #	Description	1	2-5	6-11	12-24
AT0001	Kit	243.70	234.90	228.70	223.90

**Setup fee: \$20(G)** Pricing is subject to change.

Kit Includes: Decaled Table and 2 Decaled Chairs USD MSRP (C)

#### Product Size

table: 23.5"W x 28"H x 23.5"D  
chair: 16.5"W x 31.62"H x 18.125"D

#### Finished Graphic Size

view online template

#### Product Wt.

40 lbs.



Table supports up to 100 lbs.



Chairs support up to 250 lbs each.

## ELM STREET BAR CART



From home hosting to branded events, this sleek rolling cart keeps your essentials organized and your brand front and center.

- Constructed with hi-gloss white wood
- Vibrant full-color decal
- Decals are permanent and cannot be swapped or repositioned
- Assembly required

### Elm Street Bar Cart

Item #	Description	1	2-5	6-11	12-24
ABC001	Front Decal	254.00	247.50	242.50	237.10

**Setup fee: \$20(G)** Pricing is subject to change.

White with full-color imprint USD MSRP (C)

#### Product Size

17"W x 34"H x 35"D

#### Finished Graphic Size

view online template

#### Product Wt.

36 lbs.

#### Media

decal vinyl film



Top shelf supports up to 150 lbs.; middle and bottom shelves support up to 75 lbs each.



Two locking swivel wheels.



Handle doubles as a towel bar.

**PRICES ARE SUBJECT TO CHANGE.** No setup fee on orders placed via our website.

Visit [showdowndisplays.com](http://showdowndisplays.com) for current pricing, graphic templates, product videos and assembly instructions. See pages 288-291 for order details.

SHOWDOWNDISPLAYS.COM · ASI 87188 · PPAI 254687 · SAGE 67383 · PPPC 20101202

production lead time after final proof approval  
**7 DAYS**



Shown in dye sublimation



Folds into soft carry case for easy transport.



Countertop and shelf supports up to 66 lbs. each.

## PORTABLE BAR



Serve up style anywhere with our lightest, most portable bar yet.

- Constructed with aluminum
- MDF countertop and shelf
- Available in full-color imprint or dye sublimation on removable graphic wrap; attaches via hook-and-loop
- Dye sublimation is not eligible for Rush Service

### Full-Color Imprint

Item #	Description	1	2-5	6-11	12-24
ABC012	Portable Bar Kit	160.60	156.40	153.30	149.80

Setup fee: \$20(G)

Pricing is subject to change.

Kit Includes: Hardware, Black or White Graphic Wrap and Soft Carry Case USD MSRP (C)

Product Size	Finished Graphic Size	Product Wt.	Media
39"W x 36"H x 15"D	view online template	15 lbs.	polyester

### Dye Sublimation

Item #	Description	1	2-5	6-11	12-24
ABC024	Portable Bar Kit	410.50	400.00	392.00	383.00

Setup fee: \$20(G)

Pricing is subject to change.

Kit Includes: Hardware, Dye Sublimated Graphic Wrap and Soft Carry Case USD MSRP (C)

Product Size	Finished Graphic Size	Product Wt.	Media
39"W x 36"H x 15"D	view online template	15 lbs.	polyester poplin

### Stock Portable Bar Graphic Wrap Colors

- White  Black

PMS colors are for reference only and may vary slightly from actual color.



Shown in black with full-color imprint



Folds into soft carry case for easy transport.



Two internal shelves for storage.

## PORTABLE WOOD BAR



Designed to serve, built to shine!

- Constructed with wood
- Countertop supports up to 100 lbs.
- Internal shelves support up to 50 lbs.
- Available in full-color imprint or dye sublimation on removable graphic wrap; attaches via hook-and-loop
- Dye sublimation is not eligible for Rush Service

### Full-Color Imprint

Item #	Description	1	2-5	6-11	12-24
ABC022	Portable Wood Bar Kit	351.00	342.00	335.25	327.50

Setup fee: \$20(G)

Pricing is subject to change.

Kit Includes: Hardware, Black or White Graphic Wrap and Soft Carry Case USD MSRP (C)

Product Size	Finished Graphic Size	Product Wt.	Media
41.5"W x 35.5"H x 17.5"D	view online template	39 lbs.	polyester

### Dye Sublimation

Item #	Description	1	2-5	6-11	12-24
ABC026	Portable Wood Bar Kit	601.00	585.50	574.00	561.00

Setup fee: \$20(G)

Pricing is subject to change.

Kit Includes: Hardware, Dye Sublimated Graphic Wrap and Soft Carry Case USD MSRP (C)

Product Size	Finished Graphic Size	Product Wt.	Media
41.5"W x 35.5"H x 17.5"D	view online template	39 lbs.	polyester poplin

### Stock Portable Wood Bar Graphic Wrap Colors

- White  Black

PMS colors are for reference only and may vary slightly from actual color.

production lead time after final proof approval

**7 DAYS**

PRICES ARE SUBJECT TO CHANGE. No setup fee on orders placed via our website.

Visit [showdowndisplays.com](http://showdowndisplays.com) for current pricing, graphic templates, product videos and assembly instructions. See pages 288-291 for order details.

SHOWDOWNDISPLAYS.COM · ASI 87188 · PPAI 254687 · SAGE 67383 · PPPC 20101202

## ADIRONDACK CHAIR



Classic design that's perfect for patios, porches and outdoor events.

- Supports up to 300 lbs.
- Constructed from Poplar wood
- Vibrant full-color decal
- Decals are permanent and cannot be swapped or repositioned
- Durable design
- Assembly required; screwdriver provided



Shown in azure

### Adirondack Chair

Item #	Description	1	2-5	6-11	12-24
ACH121	Front Decal	304.50	296.50	290.50	284.00

Setup fee: \$20(G) Pricing is subject to change.

Stock colors with full-color artwork. USD MSRP (C)

Product Size	Finished Graphic Size	Product Wt.	Media
35.24"W x 35"H x 32"D	view online template	31 lbs.	decal vinyl film



Chair features a built-in cupholder.

### Stock Adirondack Chair Colors

- White
- Azure PMS 286
- Crimson PMS 186
- Black

PMS colors are for reference only and may vary slightly from actual color.

## POLYRESIN ADIRONDACK CHAIR



Classic Adirondack style meets modern durability in this low maintenance polyresin chair built for lounging.

- Supports up to 300 lbs.
- Constructed from durable HDPE polyresin; commonly recyclable through a majority of curbside programs (check locally for details)
- Vibrant full-color decal
- Decals are permanent and cannot be swapped or repositioned
- Assembly required



### Polyresin Adirondack Chair

Item #	Description	1	2-5	6-11	12-24
ACH151	Front Decal	408.00	393.25	382.75	374.75

Setup fee: \$20(G) Pricing is subject to change.

White with full-color artwork. USD MSRP (C)

Product Size	Finished Graphic Size	Product Wt.	Media
28.35"W x 35"H x 35.24"D	view online template	31 lbs.	decal vinyl film



Chair features a built-in cupholder.



Folds for easy storage and transport.

## ZERO GRAVITY CHAIR



Experience next-level relaxation, whether you're poolside or at an event. This chair lets you kick back in a reclined, floating-like position.

- Supports up to 250 lbs.
- Strong, powder-coated steel frame
- Designed to evenly distribute weight and reduce pressure on joints
- Chair is constructed with rPET polyester
- Vibrant full-color imprint



Removable padded headrest.

Reclining mechanism to easily transition from sitting to lounging.

Features side table with two cupholders and storage slots.

Shown in indigo



### Zero Gravity Chair

Item #	Description	1	2-5	6-11	12-24
ACH011	Front Imprint	167.40	163.00	159.70	156.10

Setup fee: \$20(G)

Pricing is subject to change.

Stock fabric colors with full-color artwork.

USD MSRP (C)

Product Size	Finished Graphic Size	Product Wt.	Media
34"W x 39"H x 41"D	view online template	21 lbs.	rPET polyester

#### Stock Zero Gravity Chair Colors

- Crimson PMS 186
- Indigo PMS 295
- Black

PMS colors are for reference only and may vary slightly from actual color.

production lead time after final proof approval

**7 DAYS**

**PRICES ARE SUBJECT TO CHANGE.** No setup fee on orders placed via our website. Visit [showdowndisplays.com](http://showdowndisplays.com) for current pricing, graphic templates, product videos and assembly instructions. See pages 288-291 for order details.

SHOWDOWNDISPLAYS.COM · ASI 87188 · PPAI 254687 · SAGE 67383 · PPPC 20101202

## ROCKER CHAIR



Experience ultimate comfort with our lightweight, compact and portable outdoor rocking chair.

- Supports up to 260 lbs.
- Features two cupholders
- Powder-coated steel frame
- Chair is constructed with rPET polyester
- Vibrant full-color imprint



Shown in crimson

### Rocker Chair

Item #	Description	1	2-5	6-11	12-24
ACH001	Front Imprint	120.70	114.60	108.80	99.95

Setup fee: \$20(G) Pricing is subject to change.

Stock fabric colors with full-color artwork. USD MSRP (C)

Product Size	Finished Graphic Size	Product Wt.	Media
35"W x 36"H x 35"D	view online template	11 lbs.	rPET polyester

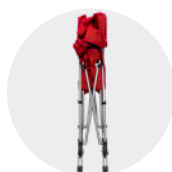

Folds to fit in included carry bag.



### Stock Rocker Chair Colors

- Crimson PMS 186
- Azure PMS 286
- Black

PMS colors are for reference only and may vary slightly from actual color.

## RETRO WEBBING CHAIR



Discover the perfect blend of retro style and modern comfort.

- Supports up to 250 lbs.
- Webbing and graphic wrap are made from polyester
- Powder-coated steel frame with solid wood armrests
- Vibrant full-color imprint



Graphic wrap is installed into the chair frame.



Shown in black

### Retro Webbing Chair

Item #	Description	1	2-5	6-11	12-24
ACH071	Front Imprint	130.00	123.40	117.20	107.60

Setup fee: \$20(G) Pricing is subject to change.

Stock fabric colors with full-color artwork. USD MSRP (C)

Product Size	Finished Graphic Size	Product Wt.	Media
22"W x 33.5"H x 16"D	view online template	8.5 lbs.	polyester



Chair features one cupholder.



Folds flat for easy storage and transport.

### Stock Retro Webbing Chair Colors

- Crimson PMS 186
- Azure PMS 286
- Black

PMS colors are for reference only and may vary slightly from actual color.

**PRICES ARE SUBJECT TO CHANGE.** No setup fee on orders placed via our website. Visit [showdowndisplays.com](http://showdowndisplays.com) for current pricing, graphic templates, product videos and assembly instructions. See pages 288-291 for order details. SHOWDOWNDISPLAYS.COM · ASI 87188 · PPAI 254687 · SAGE 67383 · PPPC 20101202

production lead time after final proof approval  
**7 DAYS**



Hook-and-loop allows for easy side panel assembly.

Shown in black with front and side imprints

## AD DIRECTOR'S CHAIR



Unmatched comfort and versatility, with a large branding area, this chair is great for any event.

- Supports up to 250 lbs.
- Lightweight steel frame
- Seat, backrest and side panels are constructed of 600 denier polyester
- Vibrant full-color imprint
- Folds flat for easy transport

### Ad Director's Chair

Item #	Description	1	2-5	6-11	12-24
ACH091	Front Imprint	76.25	72.40	68.70	63.10
ACH093	Front and Side Imprints	80.10	76.05	72.20	66.30

Setup fee: \$20(G)

Pricing is subject to change.

Stock fabric colors with full-color artwork.

USD MSRP (C)

Product Size	Finished Graphic Size	Product Wt.	Media
22"W x 30"H x 19"D	view online template	8.5 lbs.	600 denier polyester

### Stock Ad Director's Chair Colors

- Crimson PMS 186
- Indigo PMS 295
- Black

PMS colors are for reference only and may vary slightly from actual color.

## DIRECTOR'S CHAIR



This classic chair design is casual, functional and versatile.

- Made in the USA from Appalachian Beech hardwood
- Natural woodgrain will have some color and pattern variation
- Heavy-duty canvas seat and seat backing
- Supports up to 225 lbs.
- Our floor display hard case with wheels (Item #220023) will hold two director's chairs (sold separately; see page 286)



Hinges lock to keep the chair stable.

Bar-Height shown in orange with full-color imprint

Table-Height shown in burgundy with full-color imprint

### Unimprinted

Item #	Description	1	2-5	6-11	12-24
111025	Table-Height Director's Chair	212.90	206.60	200.20	193.80
111029	Bar-Height Director's Chair	246.60	239.20	231.80	224.40

Pricing is subject to change.

Stock fabric colors.

USD MSRP (C)

### Full-Color Imprint

Item #	Description	1	2-5	6-11	12-24
111026	Table-Height Director's Chair	229.00	222.10	215.30	208.40
111030	Bar-Height Director's Chair	279.00	270.50	262.25	253.75

Setup fee: \$20(G)

Pricing is subject to change.

Stock fabric colors with full-color artwork.

USD MSRP (C)

Description	Product Size	Finished Graphic Size	Product Wt.	Media
table-height	23"W x 34.25"H x 18"D (seat height 18")	view online template	11 lbs.	canvas
bar-height	24.125"W x 46.5"H x 21"D (seat height 30.25")	view online template	14 lbs.	canvas

### Stock Director's Chair Colors

- Black
- Burgundy PMS 7421
- Hunter Green PMS 3302
- Khaki PMS 7502
- Navy Blue PMS 2767
- Orange PMS 1655
- Red PMS 186
- Royal Blue PMS 2738
- White

PMS colors are for reference only and may vary slightly from actual color.



The Bar-Height chair features a footrest that naturally folds out as you open it.

AD DIRECTOR'S DIRECTOR'S production lead time after final proof approval  
**7-OR-3 DAYS**

HARDWARE-ONLY LEAD TIME: SHIPS SAME DAY WHEN ORDERED BEFORE 2 PM CENTRAL

PRICES ARE SUBJECT TO CHANGE. No setup fee on orders placed via our website.

Visit showdowndisplays.com for current pricing, graphic templates, product videos and assembly instructions. See pages 288-291 for order details.

## SLING CHAIR



Unwind in style with ultimate comfort at the beach, campsite or backyard.

- Supports up to 250 lbs.
- Constructed from Poplar wood frame with a high-gloss finish
- Chair is constructed of polyester
- Vibrant full-color imprint
- Folds flat for easy transport



### Sling Chair

Item #	Description	1	2-5	6-11	12-24
ACH171	Front Imprint	188.30	183.40	179.80	175.70

Setup fee: \$20(G) Pricing is subject to change.

Stock fabric colors with full-color artwork. USD MSRP (C)

Product Size	Finished Graphic Size	Product Wt.	Media
18"W x 32"H x 42"D	view online template	13 lbs.	polyester

#### Stock Sling Chair Colors

- White
- Indigo PMS 295
- Crimson PMS 186
- Black

*PMS colors are for reference only and may vary slightly from actual color.*

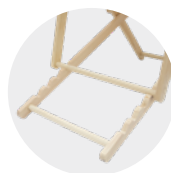

Easily adjust chair with this multi-position reclining design.



Chair features built-in cupholder.

## METAL SLING CHAIR



Durability meets style at the beach, campsite or in your own backyard!

- Supports up to 250 lbs.
- Durable, powder-coated steel frame
- Chair is constructed with rPET polyester
- Vibrant full-color imprint
- Features built-in headrest



Shown in white

### Metal Sling Chair

Item #	Description	1	2-5	6-11	12-24
ACH181	Front Imprint	160.00	155.80	152.70	149.20

Setup fee: \$20(G) Pricing is subject to change.

Stock fabric colors with full-color artwork. USD MSRP (C)

Product Size	Finished Graphic Size	Product Wt.	Media
22.4"W x 31.1"-37.8"H x 34.4"-40.9"D	view online template	14 lbs.	rPET polyester



Easily adjust chair with this multi-position reclining design.



Folds flat for easy transport.

#### Stock Metal Sling Chair Colors

- White
- Black

*PMS colors are for reference only and may vary slightly from actual color.*



Rear pocket for storage when using the chair.

Shown in azure

**Stock Bahama Beach Chair Colors**

- Crimson PMS 186
- Azure PMS 286
- Black

*PMS colors are for reference only and may vary slightly from actual color.*

**BAHAMA BEACH CHAIR**



This favorite beach chair is the perfect combination of comfort, convenience and durability for any outing.

- Supports up to 225 lbs.
- Adjustable seatback
- Folds flat and includes backpack straps for easy transport
- Lightweight aluminum frame
- Seat and backrest are constructed with rPET polyester
- Vibrant full-color imprint

**Bahama Beach Chair**

Item #	Description	1	2-5	6-11	12-24
ACH031	Front Imprint	178.40	172.00	167.40	164.00

**Setup fee: \$20(G)** **Pricing is subject to change.**  
 Stock fabric colors with full-color artwork. USD MSRP (C)

Product Size	Finished Graphic Size	Product Wt.	Media
21.5"W x 30.5"H x 29"D	view online template	8.5 lbs.	rPET polyester

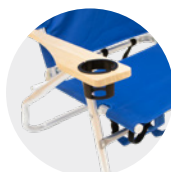

Hardwood armrests feature one built-in cupholder.



Adjustable seatback for different reclining positions.



Umbrella attaches with included hardware.

Shown in crimson

**Stock Jones Beach Chair Colors**

- Crimson PMS 186
- Indigo PMS 295
- Black

*PMS colors are for reference only and may vary slightly from actual color.*

**JONES BEACH CHAIR**



Make every beach day a breeze! This combo is complete with a clamp-on umbrella and soft cooler.

- Includes chair with adjustable clamp umbrella and six-can soft cooler
- Umbrella has 44" arc with eight-panel construction
- Chair supports up to 250 lbs.
- Powder-coated steel tubing frame with white coating and plastic armrests
- Chair is constructed with rPET polyester
- Vibrant full-color imprint on chair back and one-panel of beach umbrella
- Chair folds flat and is equipped with shoulder strap

**Jones Beach Chair**

Item #	Description	1	2-5	6-11	12-24
ACH111	Chair Front and Umbrella Imprints	68.65	65.20	61.90	56.85

**Setup fee: \$20(G)** **Pricing is subject to change.**  
 Stock fabric colors with full-color artwork. USD MSRP (C)

Product Size	Finished Graphic Size	Product Wt.	Media
28"W x 55"H x 22"D	view online template	8 lbs.	rPET polyester



Chair, soft cooler and umbrella separate for easy transport.



Soft cooler connects under the chair with hook-and-loop.

production lead time after final proof approval

**7 DAYS**

## SOUTH BEACH LOUNGER CHAIR



Lean back, sip your favorite drink, and let the good vibes roll! Designed for ultimate relaxation for lazy beach days, corporate retreats, or poolside lounging.

- Chair supports up to 250 lbs.
- Lounger-style chair with three recline positions
- Features sturdy hardwood armrests
- Lightweight, powder-coated steel frame
- Chair and cupholder are constructed of rPET polyester
- Vibrant full-color imprint
- Folds up for easy transport

### South Beach Lounger Chair

Item #	Description	1	2-5	6-11	12-24
ACH021	Front Imprint	173.30	167.00	162.60	159.20

Setup fee: \$20(G) Pricing is subject to change.

Stock fabric colors with full-color artwork. USD MSRP (C)

Product Size	Finished Graphic Size	Product Wt.	Media
22"W x 33.5"H x 53"D	view online template	16 lbs.	rPET polyester



#### Stock South Beach Lounger Chair Colors

- Crimson PMS 186
- Azure PMS 286
- Black

PMS colors are for reference only and may vary slightly from actual color.

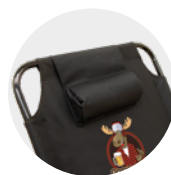

Features hook-and-loop secured removable pillow.

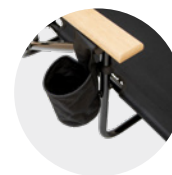

Cupholder is attached to one of the armrests.

## RIO GRANDE BEACH CHAIR



Quickly settle in at the beach with this portable and adjustable beach chair.

- Supports up to 250 lbs.
- Hardwood armrests adjust to four positions
- Powder-coated steel frame
- Chair is constructed with rPET polyester
- Vibrant full-color imprint
- Folds flat and includes padded backpack straps for easy transport

### Rio Grande Beach Chair

Item #	Description	1	2-5	6-11	12-24
ACH081	Front Imprint	138.60	133.60	130.10	127.40

Setup fee: \$20(G) Pricing is subject to change.

Stock fabric colors with full-color artwork. USD MSRP (C)

Product Size	Finished Graphic Size	Product Wt.	Media
22"W x 32"H x 19"D	view online template	8.5 lbs.	rPET polyester



Shown in indigo

#### Stock Rio Grande Beach Chair Colors

- Crimson PMS 186
- Indigo PMS 295
- Black

PMS colors are for reference only and may vary slightly from actual color.



Features pouch and cupholder underneath right armrest.

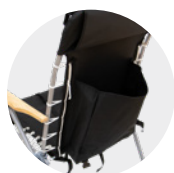

Rear pocket for storage.



## WOOD DOCK CHAIR



Effortlessly stylish and easy to take anywhere, this chair brings laid-back vibes to patios, beaches and backyard hangouts alike.

- Supports up to 220 lbs.
- Constructed from Poplar wood with a high-gloss finish
- Backrest is made with rPET Oxford cloth
- Vibrant full-color imprint

### Wood Dock Chair

Item #	Description	1	2-5	6-11	12-24
ACH161	Front Imprint	76.25	73.50	71.55	70.05

**Setup fee: \$20(G)**

**Pricing is subject to change.**

White with full-color artwork.

USD MSRP (C)

Product Size	Finished Graphic Size	Product Wt.	Media
16"W x 26"H x 22"D	view online template	8 lbs.	rPET Oxford cloth



Folds flat for easy storage and transport.



Shown in black

## ZEN MASTER TRAVEL CHAIR



This compact go-anywhere chair is perfect for camping, festivals or wherever your next adventure takes you.

- Supports up to 250 lbs.
- Powder-coated steel frame
- Chair is constructed with rPET polyester
- Vibrant full-color imprint

### Zen Master Travel Chair

Item #	Description	1	2-5	6-11	12-24
ACH051	Front Imprint	58.95	57.45	56.30	55.00

**Setup fee: \$20(G)**

**Pricing is subject to change.**

Stock fabric colors with full-color artwork.

USD MSRP (C)

Product Size	Finished Graphic Size	Product Wt.	Media
21.5"W x 26"H x 21.75"D	view online template	5.6 lbs.	rPET polyester

#### Stock Zen Master Travel Chair Colors

- Crimson PMS 186
- Indigo PMS 295
- Black

*PMS colors are for reference only and may vary slightly from actual color.*



Zippered pocket behind headrest for safe storage.



Folds to fit in included color-matched carry bag.

production lead time  
after final proof approval

# 7 DAYS

## SPORTS CHAIR



Compact, comfortable and ready for action, this is your perfect companion for every game, tailgate and outdoor adventure.

- Supports up to 250 lbs.
- Powder-coated steel frame
- Chair is constructed with rPET polyester
- Vibrant full-color imprint



Shown in spruce

### Sports Chair

Item #	Description	1	2-5	6-11	12-24
ACH041	Front Imprint	39.27	37.86	36.85	36.09

**Setup fee: \$20(G)** Pricing is subject to change.  
 Stock fabric colors with full-color artwork. USD MSRP (C)

Product Size	Finished Graphic Size	Product Wt.	Media
31.5"W x 35"H x 41"D	view online template	6.25 lbs.	rPET polyester



Folds to fit in included color-matched carry bag.

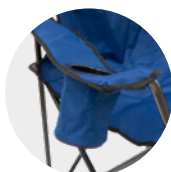

Features one cupholder.

#### Stock Sports Chair Colors

- Crimson PMS 186
- Azure PMS 286
- Indigo PMS 295
- Spruce PMS 3435
- Black

*PMS colors are for reference only and may vary slightly from actual color.*

## TAILGATING COUCH



Cheer on your team or lounge by the fire, this unique chair brings comfort and convenience wherever you take it.

- Supports up to 250 lbs.
- Extra-wide chair
- Features sturdy hardwood armrests
- Lightweight, powder-coated steel frame
- Chair and cupholders are constructed of rPET polyester
- Vibrant full-color imprint
- Folds up for easy transport



Shown in indigo

### Tailgating Couch

Item #	Description	1	2-5	6-11	12-24
ACH101	Front Imprint	147.80	144.00	141.10	137.90

**Setup fee: \$20(G)** Pricing is subject to change.  
 Stock fabric colors with full-color artwork. USD MSRP (C)

Product Size	Finished Graphic Size	Product Wt.	Media
30.5"W x 29"H x 21"D	view online template	13.5 lbs.	rPET polyester



Chair features two attached cupholders.



Extra-wide chair has room for multiple people.

#### Stock Tailgating Couch Colors

- Crimson PMS 186
- Azure PMS 286
- Indigo PMS 295
- Black

*PMS colors are for reference only and may vary slightly from actual color.*



Soft cooler holds up to 12 standard 12 oz. cans.

Shown in black

**Stock Party Chair Colors**

- Crimson PMS 186
- Indigo PMS 295
- Black

*PMS colors are for reference only and may vary slightly from actual color.*

**PARTY CHAIR**



Bring the party anywhere! Ideal for tailgates, camping, or outdoor events, it offers comfort and convenience wherever you go.

- Includes chair with connected beach umbrella and soft cooler
- Umbrella has 66" arc with eight-panel construction
- Chair supports up to 300 lbs.
- Powder-coated steel frame
- Constructed with rPET polyester
- Vibrant full-color imprint on chair back and one-panel of beach umbrella

**Party Chair**

Item #	Description	1	2-5	6-11	12-24
ACH131	Chair Front and Umbrella Imprints	122.30	119.10	116.70	114.10

**Setup fee: \$20(G)**

**Pricing is subject to change.**

Stock fabric colors with full-color artwork.

USD MSRP (C)

Product Size	Finished Graphic Size	Product Wt.	Media
55"W x 68"H x 17.5"D	view online template	13 lbs.	rPET polyester



Folds to fit in included color-matched carry bag.



Chair features two cupholders.



**DOUBLE PARTY CHAIR**



Where double the comfort meets double the cool. Bring the party anywhere!

- Includes two chairs with connected beach umbrella and soft cooler with front pocket
- Umbrella has 72" arc with eight-panel construction
- Each chair supports up to 250 lbs.
- Powder-coated steel frame
- Chairs, umbrella canopy and soft cooler are constructed with rPET polyester
- Vibrant full-color imprint on chair backs and one-panel of beach umbrella

**Double Party Chair**

Item #	Description	1	2-5	6-11	12-24
ACH063	Chair Front and Umbrella Imprints	249.80	243.30	238.50	233.10

**Setup fee: \$20(G)**

**Pricing is subject to change.**

Black with full-color artwork.

USD MSRP (C)

Product Size	Finished Graphic Size	Product Wt.	Media
64"W x 73"H x 21"D	view online template	23 lbs.	rPET polyester



Folds to fit in included carry bag.



Features built-in Bluetooth speaker.



Each chair features one built-in cupholder.



Soft cooler holds up to 12 standard 12 oz. cans.

production lead time after final proof approval

**7 DAYS**

## EASELS



Display announcements, artwork, sign frames and more with these versatile and durable easels.

- Extendable legs allow for use as a tabletop display or standalone floor display
- Tripod structure for easy placement in corners
- Each easel holds up to 20 lbs.

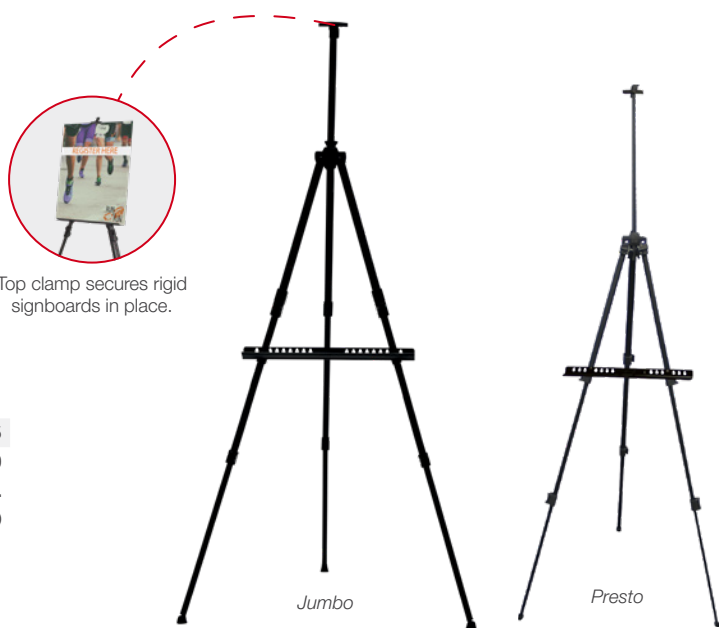

Top clamp secures rigid signboards in place.

Jumbo

Presto

### Easels

Item #	Description	1	2-5	6-11	12-24
400011	Presto Easel	80.85	77.60	74.35	71.15
400052	Jumbo Easel	129.30	124.20	119.00	113.80

Pricing is subject to change.

USD MSRP (C)

Description	Product Size	Product Wt.
presto	38"W x 20"-63.625"H x 32"D	2 lbs.
jumbo	20"W x 24"-72"H x 16"D	4.5 lbs.

## LITERATURE DISPLAYS



Keep your brochures and catalogs prominently displayed with these compact literature displays.

### Literature Displays

Item #	Description	Pocket	1	2-5	6-11	12-24
230025	Easy View Display	1.375"D	397.50	385.50	373.50	361.75
230003	Clear View Display	1.34"D	230.30	223.40	216.50	209.60
261244	Display Mate		121.00	117.40	113.80	110.10

Pricing is subject to change.

USD MSRP (C)

### Literature Display Decal

Item #	Description	Finished Graphic Size	1	2-5	6-11	12-24
230027	Easy View Decal	view online template	18.72	18.16	17.60	17.04

Setup fee: \$20(G)

Pricing is subject to change.

Graphic Decal will NOT come applied when purchased with the display.

USD MSRP (C)

Description	Product Size	Product Wt.	Media
easy view	10.75"W x 61.5"H x 14.625"D	11.75 lbs.	surface grip
clear view	10"W x 60.75"H x 11"D	11.5 lbs.	NA
display mate	13"W x 39.5"H x 15.125"D	6.4 lbs.	NA



### Clear View Display

- Four-tier design with acrylic trays
- Sturdy chrome base
- Stores literature when not in use
- Collapses to fit into included soft carry case
- Pocket size: 9.25"W x 14"H x 1.34"D



Collapsed

### Easy View Display

- Decal (sold separately) lets you personalize the front of the stand
- Five-tier design with plastic trays
- Collapses to fit into included soft carry case
- Stores literature when not in use
- Pocket size: 8.5"W x 12.375"H x 1.375"D



Collapsed

Shown with decal (sold separately)

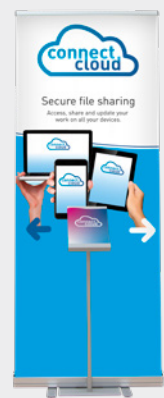

Retractable banner sold separately

### Display Mate

- Designed for use with select retractor and banner stands
- Lightweight and portable
- U-shaped steel base slides easily under display bases
- Easy to assemble
- Holds up to 3 lbs. or 300 sheets of paper
- Assembly tool included

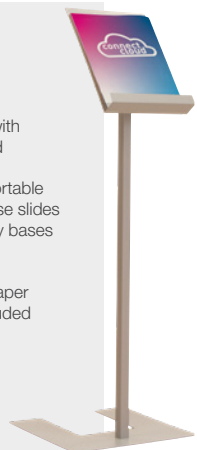

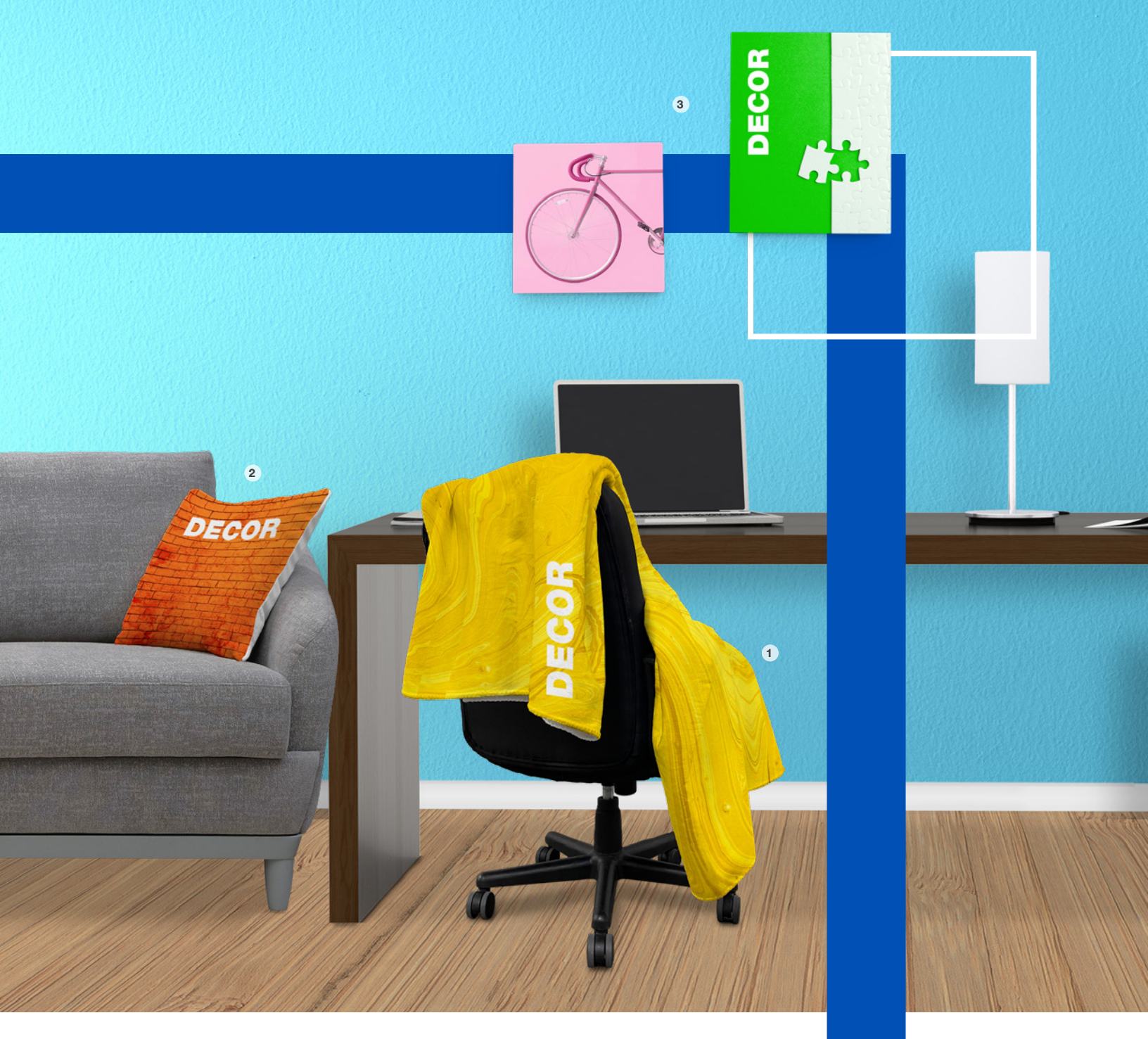

# DECOR

1. Sherpa Blanket page 281 2. Indoor Pillow page 282 3. Aluminum Prints page 283

## have you considered...

- **location** where will these products be used?
- **flexibility** will you be changing out your look and message frequently?
- **size** how large is your display space?
- **fabric/media** what type of material are you looking for?

## how to **DISPLAY**

Branded decor gives personality and consistency to your business by reinforcing your brand identity. Incorporate branded decor into lobbies, retail spaces, offices and events to create a cohesive and memorable experience.



## BLANKETS



Add extra coziness to any room with these snuggly soft blankets.

- Sherpa and Fleece artwork is dye sublimated on soft fleece fabric; Velveteen artwork is dye sublimated on soft plush fabric
- Single-sided
- Velveteen and Fleece unprinted side is white
- Sherpa unprinted side is ivory
- Machine wash on cold gentle cycle and tumble dry, no heat

### Velveteen Blanket

Item #	Description	Product Wt.	1	2-5	6-11	12-24
281113	30" x 40"	0.5 lb.	40.42	37.19	34.76	32.34
281114	50" x 60"	1.3 lbs.	60.60	58.80	56.95	55.15
281115	60" x 80"	2.1 lbs.	80.85	78.40	76.00	73.55

Setup fee: \$20(G) Pricing is subject to change.  
USD MSRP (C)

### Fleece Blanket

Item #	Description	Product Wt.	1	2-5	6-11	12-24
281116	30" x 40"	0.5 lb.	33.67	32.66	31.65	30.64
281117	50" x 60"	1.3 lbs.	53.90	52.30	50.65	49.05
281118	60" x 80"	2.1 lbs.	74.10	71.85	69.65	67.40

Setup fee: \$20(G) Pricing is subject to change.  
USD MSRP (C)

### Sherpa Blanket

Item #	Description	Product Wt.	1	2-5	6-11	12-24
281110	30" x 40"	0.8 lb.	47.15	43.38	40.55	37.72
281111	50" x 60"	2 lbs.	67.40	62.00	57.95	53.90
281112	60" x 80"	3.2 lbs.	87.60	80.55	75.30	70.05

Setup fee: \$20(G) Pricing is subject to change.  
USD MSRP (C)



Sherpa, Velveteen and Fleece feature different fabric textures.



Sherpa blanket is finished with a whipped edge.



Velveteen and Fleece blankets are finished with a hemmed edge.

PRICES ARE SUBJECT TO CHANGE. No setup fee on orders placed via our website. Visit [showdowndisplays.com](http://showdowndisplays.com) for current pricing, graphic templates, product videos and assembly instructions. See pages 288-291 for order details.

SHOWDOWNDISPLAYS.COM · ASI 87188 · PPAI 254687 · SAGE 67383 · PPCP 20101202

production lead time after final proof approval  
**3 DAYS**



## INDOOR PILLOWS



Instantly revitalize and add comfort to any space with these custom pillows.

- Artwork is printed on durable textured polyester fabric
- Single- and double-sided options available
- Vacuum sealed poly-fill pillow insert included
- Zipper closure
- Pillow cover is machine-washable; wash on cold gentle cycle and tumble dry, no heat
- Assembly required; insert pillow into cover

### Indoor Pillows (Single-Sided)

Item #	Description	Product Wt.	1	2-5	6-11	12-24
281200	16" x 16" Kit	1.2 lbs.	47.15	45.74	44.32	42.91
281202	18" x 18" Kit	1.4 lbs.	53.90	52.30	50.65	49.05
281204	14" x 20" Kit	1.3 lbs.	53.90	52.30	50.65	49.05
281206	20" x 20" Kit	1.6 lbs.	67.40	65.35	63.35	61.30

**Setup fee: \$20(G)**

**Pricing is subject to change.**

Kit Includes: Pillow Graphic Cover and Separate Vacuum Sealed Poly-Fill Insert

USD MSRP (C)

### Indoor Pillows (Double-Sided)

Item #	Description	Product Wt.	1	2-5	6-11	12-24
281201	16" x 16" Kit	1.2 lbs.	53.90	52.30	50.65	49.05
281203	18" x 18" Kit	1.4 lbs.	60.60	58.80	56.95	55.15
281205	14" x 20" Kit	1.3 lbs.	60.60	58.80	56.95	55.15
281207	20" x 20" Kit	1.6 lbs.	74.10	71.85	69.65	67.40

**Setup fee: \$20(G)**

**Pricing is subject to change.**

Kit Includes: Pillow Graphic Cover and Separate Vacuum Sealed Poly-Fill Insert

USD MSRP (C)



Textured fabric gives style and depth to the pillow cover.



The reverse side of single-sided pillows is white.



## ACRYLIC PRINTS



Create eye-catching decor with modern acrylic prints that offer sharp image detail and radiant colors.

- High-quality print on 0.118" acrylic
- Polished edge brings vibrancy and depth to the print
- Hang your art on the wall easily with attached shadow mount hardware
- Print is single-sided
- No assembly required

### Acrylic Prints

Item #	Description	Product Wt.	1	2-5	6-11	12-24
264460	5" x 7"	0.44 lb.	27.94	27.38	27.10	26.54
264461	8" x 10"	0.76 lb.	35.61	34.90	34.54	33.83
264462	11" x 14"	1.27 lbs.	57.20	56.10	55.50	54.35
264463	12" x 12"	1.2 lbs.	61.00	59.80	59.15	57.95
264464	16" x 16"	3.18 lbs.	95.35	93.45	92.50	90.55
264465	16" x 20"	3.62 lbs.	101.70	99.70	98.65	96.60
264466	20" x 30"	5.57 lbs.	139.80	137.00	135.60	132.80
264467	24" x 36"	7.4 lbs.	190.70	186.90	185.00	181.20

**Setup fee: \$20(G)**

**Pricing is subject to change.**

USD MSRP (C)



Hidden shadow mount hardware lets you hang your art on the wall like a picture frame.



Acrylic prints provide additional depth to images.

production lead time after final proof approval

**2DAYS**

**PRICES ARE SUBJECT TO CHANGE.** No setup fee on orders placed via our website.

Visit [showdowndisplays.com](http://showdowndisplays.com) for current pricing, graphic templates, product videos and assembly instructions. See pages 288-291 for order details.

SHOWDOWNDISPLAYS.COM · ASI 87188 · PPAI 254687 · SAGE 67383 · PPPC 20101202

## ALUMINUM PRINTS



Make your art shine with a sleek and modern aluminum print.

- Perfect for use as plaques, signage, or home decor
- Scratch-resistant for long-term use
- A white base coat makes colors pop
- Available with installed shadow mount or as print only
- Print is single-sided
- No assembly required

### Aluminum Prints

Item #	Description	Product Wt.	1	2-5	6-11	12-24
264220	5" x 7"	0.2 lb.	19.07	18.50	17.93	17.35
264200	8" x 8"	0.2 lb.	21.58	20.93	20.29	19.64
264202	8" x 10"	0.25 lb.	25.41	24.65	23.89	23.12
264222	8" x 24"	0.6 lb.	58.45	56.70	54.90	53.15
264224	10" x 20"	0.75 lb.	38.76	37.60	36.43	35.27
264206	11" x 14"	0.45 lb.	53.40	51.80	50.20	48.58
264204	12" x 12"	0.4 lb.	36.87	35.76	34.66	33.55
264208	12" x 18"	0.6 lb.	62.25	60.40	58.55	56.65
264226	15" x 30"	1.6 lbs.	127.20	123.30	119.50	115.70
264210	16" x 16"	0.7 lb.	52.10	50.55	48.99	47.43
264212	16" x 20"	0.8 lb.	82.60	80.15	77.65	75.20
264214	20" x 24"	1.2 lbs.	119.60	116.00	112.40	108.80
264216	20" x 30"	1.8 lbs.	152.50	147.90	143.40	138.80
264228	24" x 24"	1.7 lbs.	165.20	160.30	155.30	150.40
264218	24" x 36"	2.6 lbs.	267.00	259.00	251.00	242.90

Setup fee: \$20(G)

Pricing is subject to change.

USD MSRP (C)

### Aluminum Prints with Shadow Mount

Item #	Description	Product Wt.	1	2-5	6-11	12-24
264221	5" x 7"	0.4 lb.	25.42	24.66	23.89	23.13
264201	8" x 8"	0.4 lb.	27.94	27.10	26.26	25.43
264203	8" x 10"	0.5 lb.	31.77	30.82	29.86	28.91
264223	8" x 24"	0.8 lb.	64.85	62.90	60.95	59.00
264225	10" x 20"	0.95 lb.	45.12	43.77	42.41	41.06
264207	11" x 14"	0.65 lb.	59.70	57.90	56.10	54.30
264205	12" x 12"	0.6 lb.	43.23	41.93	40.64	39.34
264209	12" x 18"	0.8 lb.	71.80	69.65	67.50	65.35
264227	15" x 30"	3 lbs.	136.70	132.60	128.50	124.40
264211	16" x 16"	0.9 lb.	61.65	59.80	57.95	56.10
264213	16" x 20"	2.2 lbs.	92.15	89.40	86.65	83.85
264215	20" x 24"	2.6 lbs.	129.00	125.10	121.20	117.40
264217	20" x 30"	3.2 lbs.	162.10	157.20	152.40	147.50
264229	24" x 24"	3.1 lbs.	174.80	169.60	164.30	159.10
264219	24" x 36"	4 lbs.	277.00	268.75	260.25	252.00

Setup fee: \$20(G)

Pricing is subject to change.

USD MSRP (C)



Hidden shadow mount hardware lets you hang your art on the wall like a picture frame.

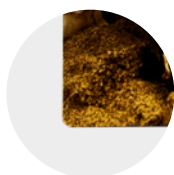

Finished with rounded corners.

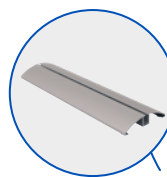

These stands feature a satin finish and turn your print into a freestanding display.



### Add-On

16" x 16" print with 12" stand

### Aluminum Print Stand

Item #	Description	Product Wt.	1	2-5	6-11	12-24
264092	8" Stand	0.2 lb.	16.88	16.20	15.53	14.85
264093	12" Stand	0.4 lb.	24.27	23.30	22.33	21.36

Pricing is subject to change.

USD MSRP (C)

8" Stand holds up to a 12" x 12" print.  
12" Stand holds up to a 16" x 16" print.



## WALL DECAL



Transform any wall in seconds with this easy to apply wall decal.

- Peel and stick for easy installation
- Low-tack adhesive removes without leaving residue; easy to reposition
- Decals work on smooth, flat, painted drywall surfaces
- Vibrant colors pop on 6 mil opaque matte white vinyl
- Spot clean with mild soap and water

### Wall Decal

Item #	Description	Product Wt.	1	2-5	6-11	12-24
325220	16" x 20"	0.16 lb.	50.85	49.32	47.80	46.27
325221	18" x 24"	0.23 lb.	57.15	55.45	53.75	52.00
325222	20" x 30"	0.32 lb.	63.60	61.65	59.75	57.85
325223	24" x 24"	0.3 lb.	69.90	67.80	65.70	63.60
325224	24" x 36"	0.45 lb.	76.25	73.95	71.70	69.40
325225	30" x 40"	0.62 lb.	82.60	80.15	77.65	75.20

Setup fee: \$20(G)

Pricing is subject to change.

USD MSRP (C)



Easily remove from backing to adhere to your wall.

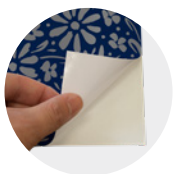

## TAPESTRIES



Accent your space with your own artistic touch.

- Artwork is dye sublimated on lightweight polyester fabric
- Crisp, laser-cut edges for a clean look
- Single-sided
- Available in three sizes
- Machine wash on cold gentle cycle and tumble dry, no heat
- Custom sizes available (call for quote; restrictions may apply)

### Tapestries

Item #	Description	Product Wt.	1	2-5	6-11	12-24
325200	51" x 60"	0.3 lb.	60.60	58.80	56.95	55.15
325201	68" x 80"	0.5 lb.	87.60	84.95	82.35	79.70
325202	88" x 104"	0.8 lb.	114.60	111.10	107.70	104.20

Setup fee: \$20(G)

Pricing is subject to change.

USD MSRP (C)

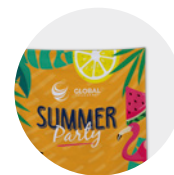

Tapestries are lightweight and easy to hang; hanging hardware not included.

production lead time after final proof approval

**2DAYS**

**PRICES ARE SUBJECT TO CHANGE.** No setup fee on orders placed via our website.

Visit [showdowndisplays.com](http://showdowndisplays.com) for current pricing, graphic templates, product videos and assembly instructions. See pages 288-291 for order details.

SHOWDOWNDISPLAYS.COM · ASI 87188 · PPAI 254687 · SAGE 67383 · PPPC 20101202

## GARDEN FLAG



Spruce up your landscape with these Garden Flags.

- Artwork is printed on 200 denier nylon
- Single- and double-sided options available
- Single-sided flags show artwork on one side with the reverse image visible through the back
- Double-sided flags feature two layers sewn together with a block-out liner in between
- Flags used outdoors have a 90-day warranty; flags used indoors have a 1-year warranty
- Not eligible for Rush Service



### Garden Flag

Item #	Description	Product Wt.	1	2-5	6-11	12-24
304630	12" x 18" Single-Sided Kit	1.25 lbs.	70.75	56.60	53.05	45.98
304631	12" x 18" Double-Sided Kit	1.5 lbs.	118.80	95.00	89.10	77.20
304635	30" x 48" Single-Sided Kit	5.5 lbs.	184.20	147.40	138.20	119.70
304636	30" x 48" Double-Sided Kit	6 lbs.	290.75	232.70	218.10	189.00

Setup fee: \$20(G)

Pricing is subject to change.

Kit Includes: Hardware and Graphic

USD MSRP (C)



Included hardware is simple to set up.

## DOOR WRAP



Decorate your home or office doors using this attractive fabric wrap.

- Artwork is dye sublimated on two-way stretch fabric
- No adhesive tape needed
- Fits standard doors 80" tall
- Double-sided graphic cover is viewable from both the front and back of the door
- Different artwork can be used on each side
- Custom sizes available (call for quote; restrictions may apply)
- Wraps used outdoors have a 90-day warranty; wraps used indoors have a 1-year warranty

### Door Wrap

Item #	Description	Product Wt.	1	2-5	6-11	12-24
263164	24"W	1.25 lbs.	163.90	159.00	154.10	149.20
263165	31"W	1.5 lbs.	189.40	183.70	178.00	172.30

Setup fee: \$20(G)

Pricing is subject to change.

USD MSRP (C)



Wraps around both sides of the door.



Easy setup: Simply slide the wrap over a door.



## HARD CASES

Add extra protection to your investment with a wide selection of hard case options.

- Hard cases feature easy-grip handles or straps
- Cases have a one-year warranty



**Item #220017**  
**Oval Hard Case with Wheels**  
 · Best for floor displays like the ARISE (Case-to-counter conversion kits sold separately; see website).



**Item #220011**  
**Square Hard Case with Wheels**  
 · Our most versatile hard case; perfect for floor displays, retractable banners and tabletop displays.



**Item #220024**  
**Round Hard Case with Wheels**  
 · Compatible with a variety of our retractors and banner displays.



**Item #220150**  
**10' or 15' Tent Hard Case with Wheels**  
 · Holds 10' or 15' tent frames.



**Item #220129**  
**Retractor Hard Case**  
 · Holds Economy, Economy Plus, Ideal or Value retractors up to 36" wide.



**Item #220395 and #220396**  
**Deluxe Hard Case with Wheels**  
 · Our foam-lined hard case is great for Astra modular displays, SEG displays and other display products.  
 · Available in two sizes.



**Item #220020**  
**Floor Display Hard Case with Wheels**  
 · Accommodates a vast array of floor displays and flat graphics.  
 · Available in two sizes.



**Item #220397 and #220397**  
**Modular Hard Case with Wheels**  
 · Designed to fit a variety of products, this case makes an ideal choice for customers seeking a reliable hard case option.



### Hard Cases

Item #	Description	Product Size	Product Wt.	1	2-5	6-11	12-24
220150	10' or 15' Tent Hard Case with Wheels	16.25"W x 66.88"H x 16.5"D	22 lbs.	371.00	363.50	356.25	345.00
220395	Deluxe Hard Case with Wheels	45.75"W x 22"H x 9.125"D	27.4 lbs.	916.00	888.50	861.00	833.50
220396	Deluxe Hard Case with Wheels	56.5"W x 26.75"H x 9.125"D	43.4 lbs.	1145.00	1111.00	1076.00	1042.00
220020	Floor Display Hard Case with Wheels	45.5"W x 36.25"H x 9.25"D	32.4 lbs.	696.00	675.00	654.00	633.50
220023	Floor Display Hard Case with Wheels	55.75"W x 26"H x 10.25"D	25 lbs.	721.00	699.50	678.00	656.00
220397	Modular Hard Case with Two Wheels	15"W x 46.5"H x 8.625"D	9 lbs.	434.50	421.50	408.50	395.50
220398	Modular Hard Case with Four Wheels	15"W x 46.5"H x 13.375"D	12 lbs.	599.50	581.50	563.50	545.50
220017	Oval Hard Case with Wheels	26.25"W x 38.5"H x 17.5"D	24 lbs.	535.50	519.00	508.50	492.50
220129	Retractor Hard Case	41.5"W x 8.75"H x 6.75"D	9 lbs.	94.80	89.15	85.35	79.65
220024	Round Hard Case with Wheels	15"W x 42"H x 18.5"D	13.5 lbs.	336.75	326.75	316.75	306.50
220011	Square Hard Case with Wheels	15.5"W x 41.25"H x 17"D	22.25 lbs.	506.00	490.75	475.50	460.25

Pricing is subject to change.

Hard cases cannot be imprinted.

USD MSRP (C)

when ordered before 2 pm central

**HARDWARE SHIPS  
 SAME DAY**

**PRICES ARE SUBJECT TO CHANGE.**

Visit [showdowndisplays.com](http://showdowndisplays.com) for current pricing, graphic templates, product videos and assembly instructions. See pages 288-291 for order details.

SHOWDOWNDISPLAYS.COM · ASI 87188 · PPAI 254687 · SAGE 67383 · PPPC 20101202

## SOFT CARRY CASES

Our broad selection of cases helps you protect your investment by making transportation and storage simple.

- Soft carry cases are constructed of 600 denier polyester and feature straps
- Cases have a one-year warranty (excludes the zip-up clear poly bag)
- Color of soft carry cases may vary



**Item #220009G**  
**Table Throw Soft Carry Case**  
 · Best for rolled table throws (see page 9 for details on storing throws).



**Item #220107**  
**Table Throw Messenger Bag**  
 · Best for folded table throws; features shoulder strap for easy transportation.



**Item #220069**  
**Zip-Up Clear Poly Bag**  
 · Ideal for folded EuroFit graphics.



**Item #220010G**  
**Soft Carry Case**  
 · Perfect for Splash, GeoMetrix and Deluxe GeoMetrix Floor Displays. Multiple case sizes available.



**Item #220085**  
**Universal Retractor Case**  
**36.25"W x 3.75"H x 5.25"D**  
 · Perfect for 31.5" & 33.5" Economy, Economy Plus and Ideal retractors.



**Item #220055**  
**Universal Retractor Case**  
**38"W x 4"H x 12"D**  
 · Works well with several of our retractors.

### Soft Carry Cases

Item #	Description	Product Size	Product Wt.	1	2-5	6-11	12-24
220010G	Soft Carry Case	34"W x 16"H x 14"D	2.25 lbs.	134.40	130.40	126.40	122.30
220007G	Soft Carry Case	38"W x 25"H x 5"D	2.5 lbs.	59.60	57.80	56.05	54.25
220107	Table Throw Messenger Bag	12.75"W x 13.5"H x 3"D	0.4 lb.	46.55	45.15	43.76	42.36
220009G	Table Throw Soft Carry Case	38"W x 5"H x 5"D	0.75 lb.	49.88	48.38	46.89	45.39
220085	Universal Retractor Case	36.25"W x 3.75"H x 5.25"D	2 lbs.	79.00	76.60	74.25	71.90
220055	Universal Retractor Case	38"W x 4"H x 12"D	4.5 lbs.	90.05	87.35	84.65	81.95
220069	Zip-Up Clear Poly Bag	14.5"W x 17"H x 3"D	0.25 lb.	4.00	3.88	3.76	3.64

Pricing is subject to change.  
 USD MSRP (C)

Soft carry cases cannot be imprinted.

## LED LIGHT KITS



### LED Light Kits

Item #	Description	1	2-5	6-11	12-24
150120	Ultimate Single Light Kit	199.50	193.50	187.50	181.50
150121	Ultimate Double Light Kit	374.00	362.75	351.50	340.25
150133	Prime Single Light Kit	187.50	181.80	176.20	170.60
150122	Tent Single Light Kit	90.00	88.20	86.40	83.70

Pricing is subject to change.

Ultimate Kit Includes: Light(s), Clamp(s), Clip(s), USB Adapter and Soft Carry Case  
 Prime Kit Includes: Light and Soft Carry Case  
 Tent Kit Includes: LED Light and USB Charging Cord  
 USD MSRP (C)

### EuroFit Light Clamp

Item #	Description	1	2-5	6-11	12-24
255125	Light Clamp	7.56	7.33	7.11	6.88

Pricing is subject to change.  
 USD MSRP (C)



EuroFit light clamp (sold separately) attaches Ultimate LED Light Kits to horizontal tubing on compatible EuroFit displays.



### LED Tent Light Kit

- Universally mountable LED light features hook-and-loop straps to attach to any tent frame truss
- Included magnets to attach to a steel tent frame
- Features multiple brightness levels
- USB-rechargeable for convenient, cord-free lighting
- Operates up to 8 hours on maximum light mode
- UL listed



### Ultimate LED Light Kits

- 11.75" stalk puts almost a foot of distance between the light and the display
- Adjustable joints at both ends of the unit let you angle each light to maximize impact
- Interchangeable attachments feature a clamp or clip, each compatible with a broad variety of displays
- Each light is powered by an attached 10' USB cord
- Soft carry case included



### Prime LED Light Kit

- Easy tightening clamp secures the light in place
- Clamp opens to 2.125"
- Ideal for use with the Journey and TRIGA® Go displays
- Plugs into any standard USA outlet
- Soft carry case included

## PRICES ARE SUBJECT TO CHANGE.

Visit [showdowndisplays.com](http://showdowndisplays.com) for current pricing, graphic templates, product videos and assembly instructions. See pages 288-291 for order details.

SHOWDOWNDISPLAYS.COM · ASI 87188 · PPAI 254687 · SAGE 67383 · PPPC 20101202

when ordered before 2 pm central

**HARDWARE SHIPS  
 SAME DAY**



## PRODUCT TEMPLATES

Templates ensure artwork is printed correctly. Always use the most recent templates, which can be found in the "Templates/Specs" tab on each product page of our website.

- Templates are specifically created for each stock product
- Do not leave template lines in artwork
- Templates for custom products are created after receipt of complete purchase order

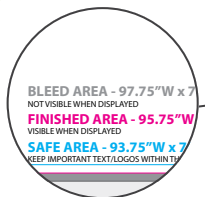

Each template includes file setup specs for sizing your artwork, including the bleed, finished and safe areas.

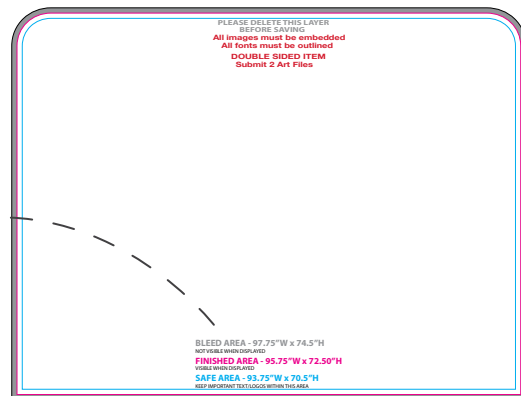

PRINT METHOD	ACCEPTABLE FILES	FILE FORMAT	PRINTING SPECIFICATIONS
Full-Color Imprint	Vector with fonts outlined	<b>Adobe Illustrator</b> ai, eps or pdf	<ul style="list-style-type: none"> <li>• All files are printed in CMYK (process color)</li> <li>• PMS (spot) colors and RGB files will be converted to CMYK prior to printing</li> <li>• Halftones/percentages of PMS colors are acceptable</li> <li>• Minimum line thickness: 0.125" (8-9 pt. stroke)</li> <li>• Minimum of 0.25" width and height on all individual elements</li> <li>• Minimum of 0.5" x 0.5" for all registered trademarks, trademarks, copyright symbols, etc.</li> </ul>
Full-Color Inkjet & Full-Color Dye Sublimation	Vector with fonts outlined and links embedded	<b>Adobe Illustrator</b> ai, eps or pdf	<ul style="list-style-type: none"> <li>• <b>Use product template to set up print-ready artwork</b></li> <li>• All files are printed in CMYK (process color)</li> <li>• PMS (spot) colors and RGB files will be converted to CMYK prior to printing</li> <li>• Full-color artwork including gradients, taster/photo images and bleeds</li> <li>• Raster images must be created at actual size with 200 dpi resolution</li> <li>• Minimum of 24 pt. reversed-out text</li> <li>• Minimum of 12 pt. regular text</li> <li>• Minimum line thickness: 1 pt. regular text, 2 pt. reversed-out text</li> </ul>
	Raster	<b>Adobe Photoshop (High Resolution)</b> tif, psd, eps, pdf, jpg	
Embroidery	Vector with fonts outlined	<b>Adobe Illustrator</b> ai, eps or pdf	<ul style="list-style-type: none"> <li>• Vector artwork required (PMS colors required)</li> <li>• Maximum of 6 thread colors</li> <li>• Maximum of 8,000 stitches</li> <li>• Minimum line thickness: 0.039" (2.8 pt. stroke)</li> <li>• Minimum of 0.21" height on all individual elements</li> </ul>
Laser Etching & Engraving	Vector with fonts outlined	<b>Adobe Illustrator</b> ai, eps or pdf	<ul style="list-style-type: none"> <li>• One color artwork required</li> <li>• Minimum line thickness: 0.028" (2 pt. stroke)</li> <li>• Minimum of 0.25" width and height on all individual elements</li> </ul>

## ART SPECIFICATIONS



.eps, .ai, .pdf

### VECTOR ART (Recommended for all products)

- Can be scaled to any size while maintaining quality
- Known as line art
- Vector artwork is preferred (unless printing photos)



.tif, .psd, .eps, .pdf, .jpg

### RASTER ART

- Known as bitmap art
- Composed of pixels (or tiny squares) grouped together to make one complete image
- When scaled larger, the image will look pixelated (or jagged)
- Submit art at 200 DPI (dots per inch) at full size

### OUTLINED FONTS (Required for all products)

Font selection can vary from computer to computer, which can cause a desired font to be replaced with a generic one. To preserve your fonts, always outline, embed, or convert them to curves before submitting artwork.



Original font



Missing font replaced with a generic one



Original font when outlined, embedded or converted to curves



200 DPI

High resolution images include: Unedited, original raw digital photos and stock photos

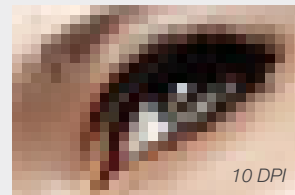

10 DPI

Low resolution images include: Photos taken from the internet, scanned images, screenshots, etc.

### EMBEDDED IMAGES (Required for all products)

Most programs allow the user to add an image to a file by linking or embedding. Embedded images are stored within the document itself, while linked files are not. Because of this, linked files can suddenly vanish when opened from a different computer. Embed all images to avoid losing them when files are submitted.

### UNACCEPTABLE FILE FORMATS:

Quark, Corel Draw, Word, PowerPoint, Excel, Publisher, Pagemaker, low-resolution scanned images and files over 2 GB. (InDesign files, unless exported to .eps or .pdf format, will incur additional charges or be rejected).

## FILE PREPARATION

### PRODUCT TEMPLATES - SHOWDOWNDISPLAYS.COM

Graphic templates can be found in the "Templates/Specs" tab on each product page of our website. Graphic dimensions are subject to change without notice.

### REQUIREMENTS

Documents must be print-ready and submitted at 100% final size, with no additional manipulation necessary; additional charges may apply if these terms are not met. Before submitting artwork, convert all text to outlines, paths or curves to ensure exact duplication of type style. All images should be embedded. Alterations to submitted artwork will result in a necessary proof approval, which may delay production time. We reserve the right to delay or reject any order based on the quality of the artwork received.

We also reserve the right to make slight alterations to your file to adapt to our printing process. Some thin lines or small shapes may not reproduce at the size or thickness submitted. Multicolor close-registration prints are not available on all products.

Please see page 288 for specific information relating to each print method.

## ARTWORK SUBMISSION & PROOFING

### UPLOADING ARTWORK

For the fastest and most efficient artwork processing, please submit art via our website:

<https://www.showdowndisplays.com/artwork>

You must have an account and be logged in. Our factory will not be held responsible for any server malfunction that affects the receipt of your files.

### ELECTRONIC PROOFS

Proofs are provided electronically in PDF format. These depict a low-resolution representation of the final product and should not be used for final color output or image resolution. Additional proofs may incur a proof revision charge of \$10.00(G) each, plus additional design time. Proof approvals must be submitted via our online proofing system before production will begin.

**All proof approvals received after 12:00 p.m. Central will be counted as received on the next business day. Production time begins after the final proof approval is received.**

## GRAPHIC DETAILS

### ERRORS

We will not be held responsible for errors resulting from copy that was received or approved incorrectly.

### TYPESETTING

Our normal art setup fee includes up to three lines of copy. If a specific font is required, the name of that font must be noted on your purchase order. If we do not have the desired font, the type will be re-set using a standard font or one that matches the desired font as closely as possible.

### CHANGE OF COPY CHARGE

Whether for a new or repeat order, any request for an addition, deletion or change to the copy in a vector artwork file will result in an **\$10.00(G) Change of Copy Charge**.

## REPEAT ORDERS

There are no setup fees for exact repeat orders placed within two years of original order. Any artwork older than two years must be resubmitted. Proof approvals are required on all repeat orders.

**\*\*\*ARTWORK THAT HAS BEEN ALTERED IN ANY WAY CANNOT BE CONSIDERED FOR A REPEAT ORDER\*\*\***

## COLOR

### COLOR POLICY

All of our products are printed CMYK (process color). If your artwork requires a specific color, please request a test grid (see below).

**WE CANNOT GUARANTEE COLOR MATCHING.**

### TEST GRID\*

If you are concerned about a specific color, we suggest ordering a test grid. Test Grids are printed samples of your requested PMS (spot) color and its surrounding color family (e.g. reds, blues, etc.) Using process colors, we will replicate the PMS color within the processes capability. Please state on your purchase order that you are requesting a test grid and the specific PMS color(s) you are trying to achieve.

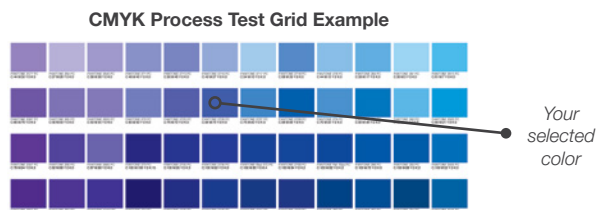

### MATCH PRINT\*

A match print is a 1/4 scale print of an entire art file. This is the most accurate way to represent an entire printed piece, since it will mimic the color and appearance of the piece as a whole, excluding any finishing. Please state on your purchase order that you are requesting a match print so it will be recorded on your order.

### TEST STRIPS\*

For the most detailed representation of full-size print quality and image resolution, we recommend requesting a test strip. An 8" x 20" section of the art is printed at 100%. Please state on your purchase order that you are requesting a test strip, including portion of art you would like to see, so it will be recorded on your order.



*\*The first test grid, match print or test strip is available at no charge (customer to pay freight). Each additional test grid, match print or test strip is \$20.00(G) plus freight, expedited charges apply.*



### PROP 65 APPROVED

All of the products in this catalog have been tested to Proposition 65 standards for Lead, Cadmium and Phthalates. Every one of these products can be sold in the state of California without a Prop 65 warning label.



### COLOR ACCURACY

Our customers deserve the highest-quality prints and most consistent, accurate color possible. As a G7 Master Qualified printer, we provide industry-leading color accuracy throughout our printing and production processes.

## HOW TO ORDER

### WEB ORDERS – SHOWDOWNDISPLAYS.COM

Orders placed via our website will receive a 2% discount and setup fees will be waived (excludes embroidery). Submit art at time of order placement for faster order processing.

### EMAIL ORDERS – ORDERS@SHOWDOWNDISPLAYS.COM

Orders may be emailed.

### PHONE ORDERS – 888-376-7469

Our Customer Care team is dedicated to helping you place an order. Please give us a call during our customer service hours: 7:00 a.m. to 6:00 p.m. Central, Monday through Friday.

### FAX ORDERS – 763-746-1133

Faxed orders are accepted as original orders. Any written confirmation of a faxed order must be marked "CONFIRMATION OF FAX – DO NOT DUPLICATE" to avoid duplicate orders.

### HARDWARE-ONLY ORDERS

Most hardware-only orders placed before 2:00 p.m. Central will ship the same day (subject to capacity and inventory levels). Customer Care will inform you of any shipment delays at the time of ordering.

### IMPRINTED PRODUCTS

Refer to the product's production lead time. See the DEFINITIONS section for details.

ALL ORDERS/APPROVALS RECEIVED AFTER NOON CENTRAL WILL BE PROCESSED ON THE NEXT BUSINESS DAY. OUR FACTORY IS NOT RESPONSIBLE FOR ANY OMITTED INFORMATION OR SERVER/FAX MALFUNCTIONS THAT AFFECT RECEIPT OF THE ORDER.

## ORDERING DETAILS

### PRICING

Prices are subject to change; visit [showdowndisplays.com](http://showdowndisplays.com) for the most current pricing.

### CREDIT/PAYMENT TERMS

All orders must be prepaid until credit terms are established. We accept Visa, MasterCard and American Express credit cards. All new customers are required to prepay their first order. Credit application is available on our website: [showdowndisplays.com](http://showdowndisplays.com)

### ORDER CHANGES & CANCELLATIONS

No graphic or product manufacturing changes will be accepted after final proof approval. Customer is responsible for all labor and material costs incurred prior to cancellation and will be billed accordingly.

## SHIPPING

### MULTIPLE DROP-SHIP ADDRESSES OR SPLIT SHIPMENTS

A \$5.00(G) fee will be added for each additional address, plus all applicable shipping and handling. Contact Customer Care for the formal drop-ship address document to complete. Additional fees may apply depending on the request.

### SHIPPING

Visit our website for shipping information and packing dimensions. Printed products ship F.O.B. Ramsey, MN 55303 or Orangeburg, NY 10962. Special shipping and pricing guidelines apply to oversized products to ensure product is delivered intact and on time.

## RETURN POLICY

### CLAIMS/RETURNS

Any damages or discrepancies must be reported within five days of receipt of merchandise. We reserve the right to not honor any claims not reported within five days. Returns will not be accepted after 90 days and cannot be returned without prior authorization from our factory. Returns may be subject to a 15% restocking fee. Contact Customer Care for additional processing information about claims or returns.

## SUBSTITUTIONS

Due to unavoidable style modifications and enhancements to the products within this catalog, we may need to substitute a product with a similar item of comparable cost and style. We reserve the right to withdraw any product offering without prior notification.

## DEFINITIONS

### SETUP FEE

Setup charges represent all costs in preparing print process-ready artwork for production, as well as email proofing and two years of archival storage.

Setup fees are \$20.00(G).

### EMBROIDERY TAPE FEE

Embroidery tape fee represents all costs in converting printed artwork into a series of stitches for embroidery.

Embroidery tape fee is 110.00(G).

### LESS THAN MINIMUM FEE

Requests for orders below the minimum quantity requirement will be reviewed and processed on a case-by-case basis.

A surcharge of \$125.00(G) will be applied to approved orders that do not meet the minimum quantity for a specific product. This fee covers additional setup and handling costs.

**Note: Certain products cannot be ordered below the minimum quantity—please contact Customer Care for details.**

### RUSH CHARGES/FEEs

Rush service is available for most products not included in our Quick Ship program; this requires prior approval by Customer Care. All documents received after 12:00 p.m. Central will be counted as received on the next business day. Same-day service is not available.

Standard rush charges:

Subtract one business day from product lead time = \$75.00(G)

Subtract two business days from product lead time = \$125.00(G)

### PRODUCTION LEAD TIMES

A production lead time is the amount of time it takes our factory to produce a finished product once final proof approval is received. Production lead times are listed for each product on their respective catalog pages and are subject to capacity and inventory levels. Your order will be scheduled within our production lead times or with rush service as requested to meet a required in-hands date. The factory reserves the right to adjust lead times. Customers will be contacted regarding affected orders.

Production begins upon receipt of:

- Complete purchase order
- Payment/credit approval
- Production-ready artwork
- Final proof approval

Your order will ship on or before the scheduled ship date via the freight method requested on the purchase order.

### WARRANTY

All of our products are designed to be cost-effective and durable. Unless otherwise stated on the product's catalog page, standard hardware warranty is a one-year parts and labor warranty, which warrants product against defects in material or workmanship. Warranties do not cover damage due to accidents, abuse, or normal wear and tear. Products found to be defective will be replaced at the discretion of our factory.

### TRADEMARKS

By submitting artwork to our factory, the customer assumes full responsibility for its use. Our factory will not be held responsible for submitted artwork that violates applicable laws or restrictions.

## SAMPLES

### BLANK SAMPLES

#### Available on select products.

- All blank samples greater than \$25.00(C) at 4<sup>th</sup> column are billed at 4<sup>th</sup> column
- All blank samples less than \$25.00(C) at 4<sup>th</sup> column are free; limit one per customer inquiry
- All samples requested must ship 3rd party UPS or FedEx
- Samples are not returnable for refund
- Requests for samples must be submitted in writing via purchase order or email order to ensure accuracy
- Less Than Minimum fee does not apply to blank sample orders

### SPEC SAMPLES

#### Available upon request only prior to an order being placed.

- Spec samples are billed at 4<sup>th</sup> column
- All spec samples are subject to associated setup charges
- All spec samples are subject to a Less Than Minimum fee of \$125.00(G) if the order does not meet the minimum quantity for a specific product. This fee covers additional setup and handling costs.
- If a production order results from a spec sample, the setup fee and Less Than Minimum fee will be waived for that order

### PRE-PRODUCTION SAMPLES

#### Available upon request only after an order has been placed.

- Contingent on receiving a purchase order
- Billed at order rate

## CREATIVE SERVICES

Utilize your very own design team. Our Creative Services team provides services such as static virtuals, 3D virtuals, designing/laying out artwork on our products, creating print ready artwork and recreating low quality logos.

### Over 60% of virtuals become orders.

#### bailey & juniper

Your logo and artwork



Virtual sample

#### VIRTUALS

- Design and layout are not included
- Not available for Quick Ship products or in-house orders
- Virtual samples depict a rough representation of the product and should not be used for proofing
- Free service is limited to three virtual samples
- Not all products are available as 3D virtuals



Go from basic...

...to brilliant!

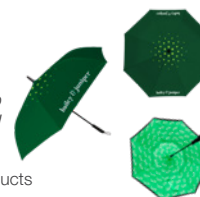

#### DESIGN TIME

- Design services are not available for Quick Ship products
- Additional lead time is required for design services
- Design services are only available for our product line
- Projects extending beyond quoted design time due to customer revisions will require the purchase of additional design time

30 minutes of design time is \$60.00(G)

## BEAUFORT SCALE - WIND RATING

Beaufort Number	Wind Speed (miles per hour)	Description	Wind Effects on Land
0	<1	Calm	Calm. Smoke rises vertically.
1	1-3	Light Air	Wind motion visible in smoke.
2	4-7	Light Breeze	Wind felt on exposed skin. Leaves rustle.
3	8-12	Gentle Breeze	Leaves and smaller twigs in constant motion.
4	13-18	Moderate Breeze	Dust and loose paper are raised. Small branches begin to move.
5	19-24	Fresh Breeze	Small trees begin to sway.
6	25-31	Strong Breeze	Large branches are in motion. Whistling is heard in overhead wires. Umbrella use is difficult.
7	32-38	Near Gale	Whole trees in motion. Some difficulty experienced walking into the wind.
8	39-46	Gale	Twigs and small branches break from trees. Cars veer on road.

Select products have been rated on the Beaufort Wind Scale. See rating icon underneath the product name. Wind ratings were determined utilizing all available securing/stabilizing options sold with or offered for the product.



Our corporate philosophy is to provide opportunity and security for all our employees. Since 2011, we've extended this philosophy beyond our walls through our partnership with Common Hope.

Through Common Hope, our employees sponsor more than 55 children in Guatemala. Our sponsorships help to improve the lives of these children and in turn their families, through education, health care and housing. Without help, the path to secondary education can be unattainable as the average child in Guatemala typically receives only 5 years of schooling. In addition to our sponsorships, we've had several volunteer teams travel to Guatemala, where they've helped construct homes, make repairs, paint and even build a playground!

**PLEASE VISIT [WWW.COMMONHOPE.ORG](http://WWW.COMMONHOPE.ORG) AND JOIN US IN HELPING THE CHILDREN OF GUATEMALA.**

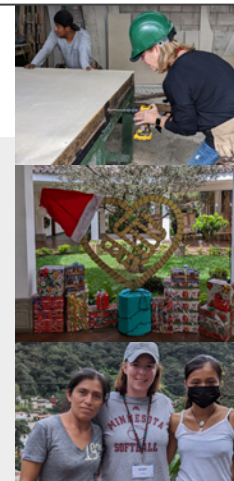

# On Target • On Time



**Distributed by:**

**Valid through December 31, 2026**

