



THE ART OF SUCCESSFUL PRESENTATION

Professional information and communication with OCTANORM Display Systems



DISPLAY AND PRESENTATION SYSTEMS

Welcome to the World of Systems powered by OCTANORM!

Whether at exhibitions, events, retail environments or point-of-purchase, graphic displays are designed to be noticed. OCTANORM can meet the requirements of all these situations with a comprehensive range of display and presentation systems. They offer the choice of portable lightweight displays or more permanent heavy-duty structures with or without illumination. In addition, whatever the scale of your presentation, you can choose standard or custom-build units.

The systems are produced in accordance with the OCTANORM philosophy: “Creative design using top quality materials to produce simple and easy to handle systems”.

FABRIC DISPLAYS

OCTAWALL MOBIL 4 - 11
OCTALUMINA 120 12 - 13
VARIO D2 14 - 15
ROLLDOWN WALL 16 - 17

1

PANEL DISPLAYS

OCTAWALL 18 - 23

2

PORTABLE DISPLAYS

OCTAPOLE 24 - 25
VARIO D4 26 - 27
VARIO D400 28 - 31

3

BANNER DISPLAYS

VARIO D100 32 - 33
VARIO D5 STRING 34 - 35

4

EVENT SERIES

VARIO EVENT TENT 36 - 39

5

COUNTERS

OCTACOUNTER 40 - 41
VARIO PROMOTION COUNTER 42-43

6

DIGITAL PRESENTATION

VARIO D2 MONITOR PRESENTATION 44 - 45
MONITOR APPLICATIONS 46 - 47
IPAD STANDS 48 - 49

7

LITERATURE DISPLAYS

50 - 51

8

ACCESSORIES

WORKSTATIONS 52 - 53
MAGNETIC FIXTURES 54 - 55
RETURN WALLS 56 - 57

9

CASES

58

10

OCTAWALL MOBIL - FABRIC DISPLAY

The fabric wall system for display, exhibition and partition walls that provide outrageously efficient wall constructions like you have never seen before. A perfect solution for every room and every need. Modern, simple and aesthetic. When used in combination with the OCTANORM Magnetic System it allows for a variety of merchandising options.



Design example: OM9000 plus accessories. Monitor not included



LED arm light VA5021



Graphic header OM9550

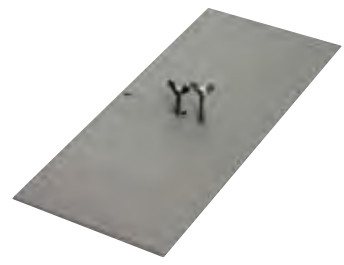

Base plate M1953

BASIC MODULES



FABRIC DISPLAYS

Frame Dimensions

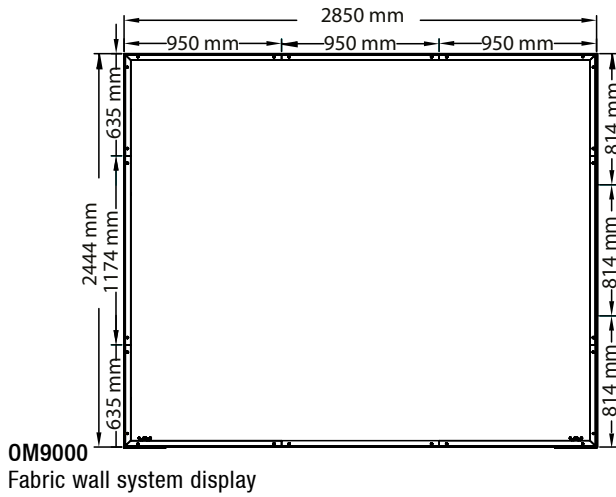

Graphic Dimensions

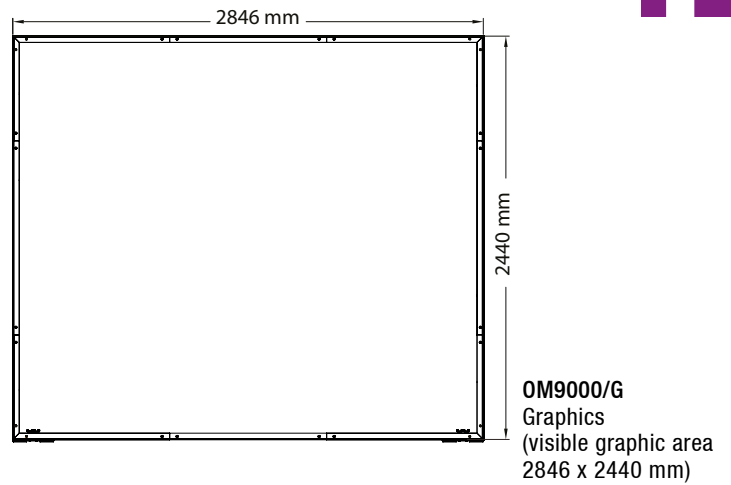

ACCESSORIES

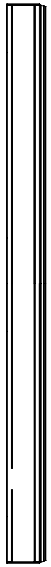

C 404K
LED light kit
with C404



W 910
Cover extrusion



OW 9560
Workstation

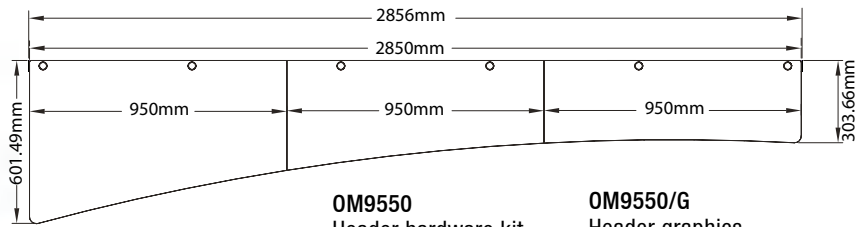

OM9550
Header hardware kit

OM9550/G
Header graphics
3 panel

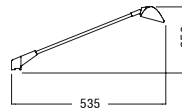

VA5021
LED arm light



OW950
Roto-molded case,
2 built-in wheels,
molded-in handle and
telescoping lid
1295 x 686 x 254 mm
gray

TECHNICAL INFORMATION

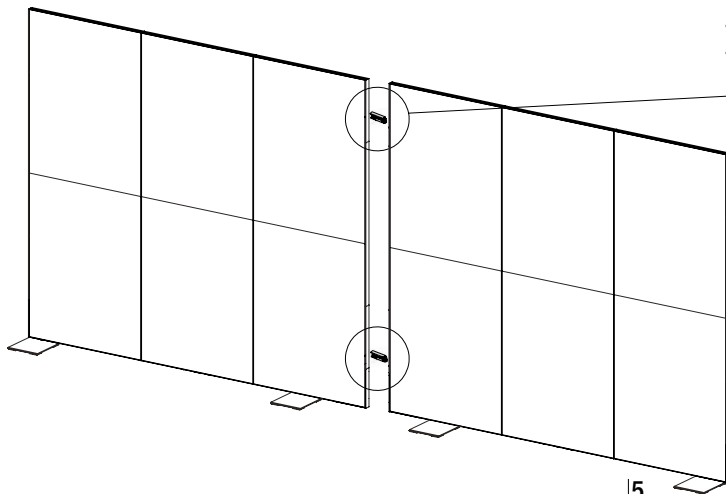

Use Z961/13.00 to lock
two frame sections
together

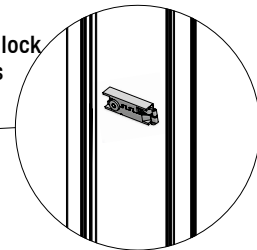

OCTAWALL MOBIL II- FABRIC DISPLAY

The fabric wall system display, exhibition and partition walls that provides outrageously efficient wall constructions like you have never seen before. A perfect solution for every room and every need. Modern, simple and aesthetic. When used in combination with the OCTANORM Magnetic System it allows for a variety of merchandising options.



Design example: OM9001 plus accessories



LED arm light VA5021



Panel retainer M1456.39



Workstation OW9560

Frame Dimensions

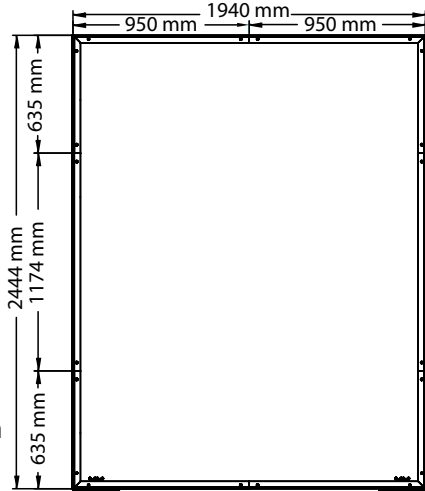

Graphic Dimensions

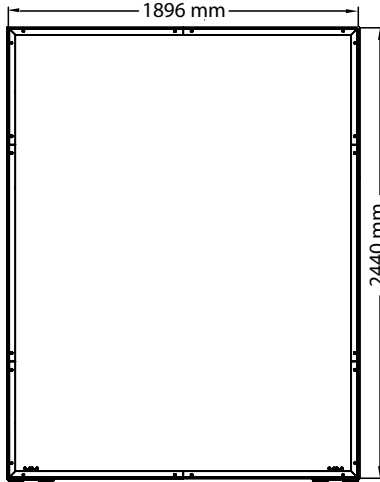

OM9001
Fabric wall system display

OM9001/G
Graphics
(visible graphic area
1896 mm x 2440 mm)

ACCESSORIES

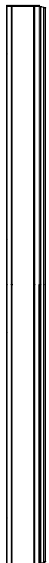

C 404K
LED light kit
with C404

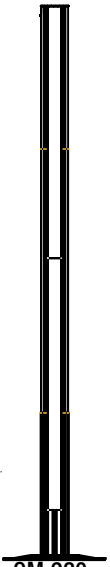

OM 920
M215 LED
post kit



OW9560
Workstation

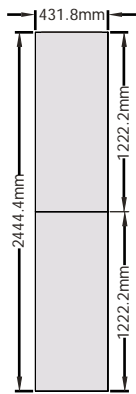

OW9500
Wing panel set

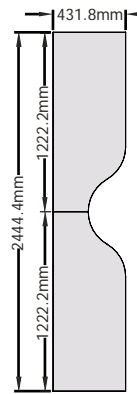

OW9510
Wing panel set

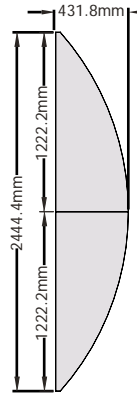

OW9520
Wing panel set

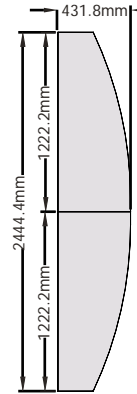

OW9530
Wing panel set

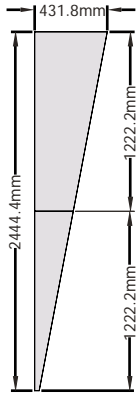

OW9540
Wing panel set

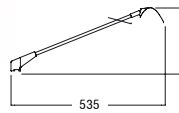

VA5021
LED arm light

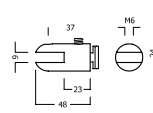

M1456
Panel hardware set,
8 needed

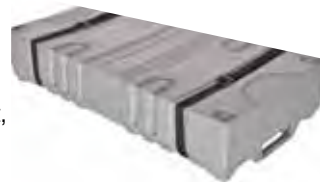

OM950
Roto-molded case,
2 built-in wheels,
molded-in handle and
telescoping lid
1295 x 686 x 254 mm
gray

TECHNICAL INFORMATION

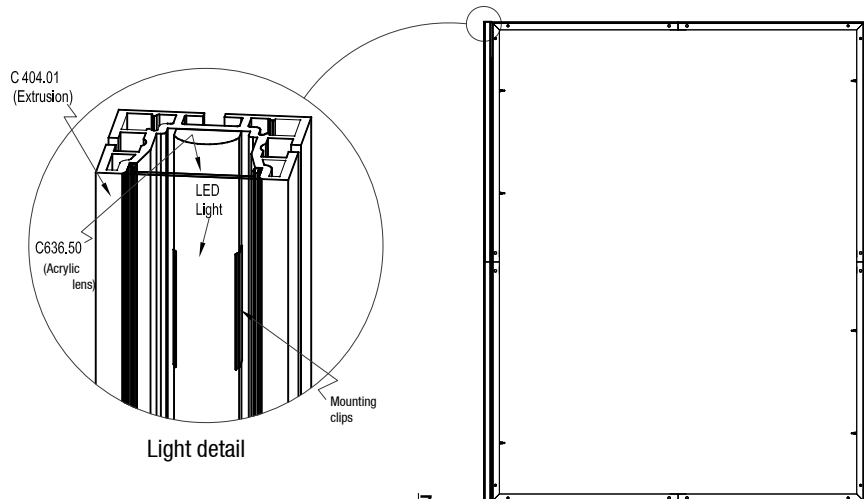

OCTAWALL MOBIL CURVED- FABRIC DISPLAY

The fabric wall system for display, exhibition and partition walls that provides outrageously efficient wall constructions like you have never seen before. A perfect solution for every room and every need. Modern, simple and aesthetic.



Design example: OM9002 plus accessories. Monitor not included



LED arm light VA5021



Workstation OW9560



Base plate M1953

BASIC MODULES



FABRIC DISPLAYS

Frame Dimensions

Graphic Dimensions

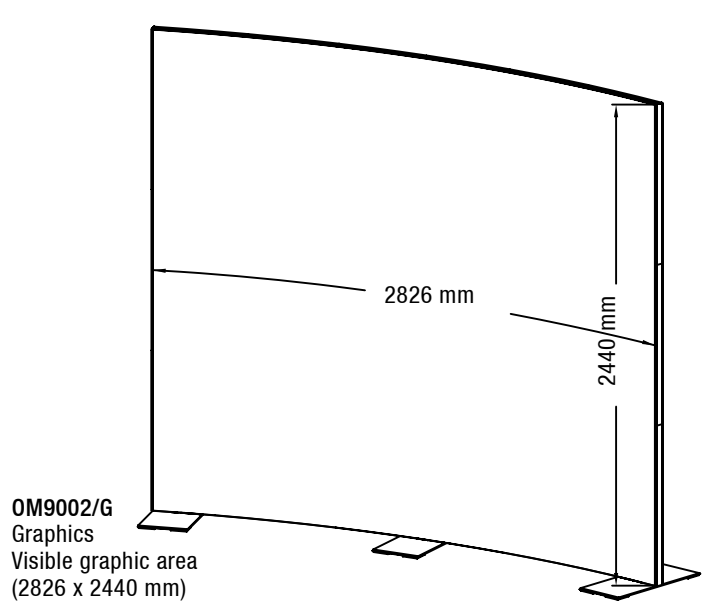
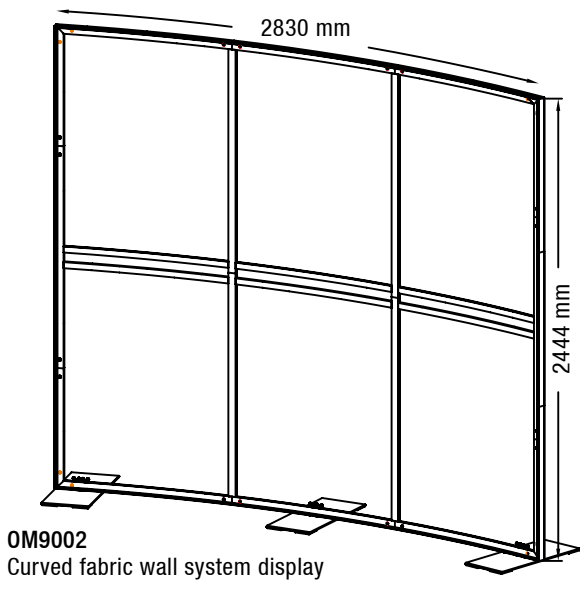

ACCESSORIES

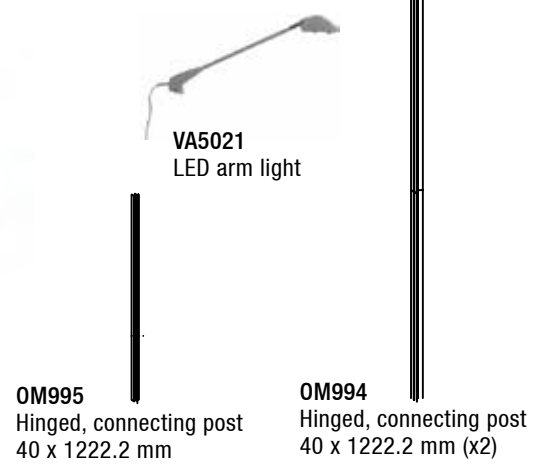
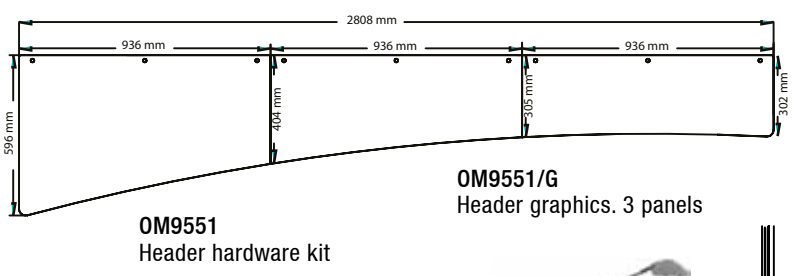

TECHNICAL INFORMATION

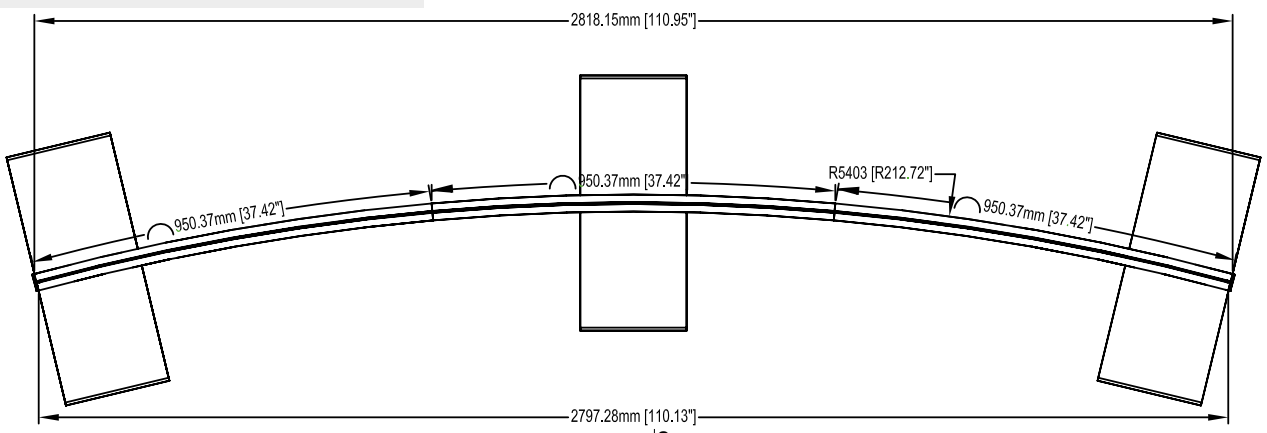

OCTAWALL MOBIL CURVED II- FABRIC DISPLAY

The fabric wall system for display, exhibition and partition walls that provides outrageously efficient wall constructions like you have never seen before. A perfect solution for every room and every need. Modern, simple and aesthetic.



Design example: OM9003 plus accessories



LED arm light VA5021



Workstation OW9560



Illuminated extrusion C404

BASIC MODULES

Frame Dimensions
2850 mm

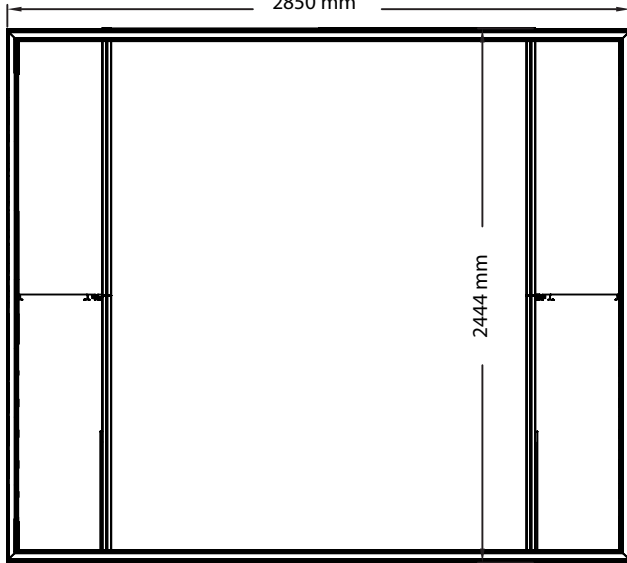

OM9003/G
Graphics sizes will be provided.

OM9003
Curved fabric wall system display

ACCESSORIES



OW9560
Workstation



VA5021
LED arm light



VK6310
Roto-molded case, two built-in wheels,
molded-in handle and telescoping lid
1295 x 686 x 254 mm
gray

TECHNICAL INFORMATION

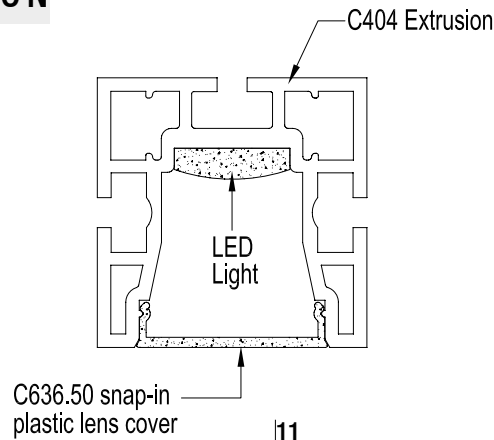

OCTALUMINA 120-FABRIC DISPLAY

OCTAlumina sets the standard in terms of quality and ease of assembly. High intensity Cree LEDs provide an even illumination of the OCTAlumina graphic. LED lights and power supply units are preinstalled and ready for connection, saving you valuable time and money.



Design example: OL1230 plus accessories. Monitor not included.



LED arm light VA5021



Base plate M1953



Workstation OW9560

ITEM NO. DIMENSION

OL 1210.01 W 1000 x H 2444 mm

OL 1220.01 W 2000 x H 2444 mm

OL 1230.01 W 3000 x H 2444 mm

OL 1240.01 W 4000 x H 2444 mm



Graphics sizes will be provided.

ACCESSORIES



OW9560 Workstation



VA5021 LED arm light



VK6310 Roto-molded case, two built in wheels, molded-in handle and telescoping lid 1295 x 686 x 254 mm gray

TECHNICAL INFORMATION

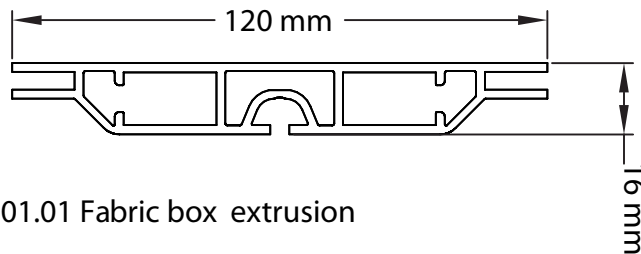

M1901.01 Fabric box extrusion

VARIO d2 FABRIC DISPLAY

The system is simplicity itself. The fabric graphic is inserted into the pole pocket of the extrusion and attached to the uprights. Top and bottom beams can be adjusted to accommodate fabrics of various heights and also adjust tension. Available in lit and non-lit versions.



Design example: M1350 plus accessories.



LED arm light VA5021



Cone, M1438



Base plate M824.21 and upright M215.01

Frame Dimensions

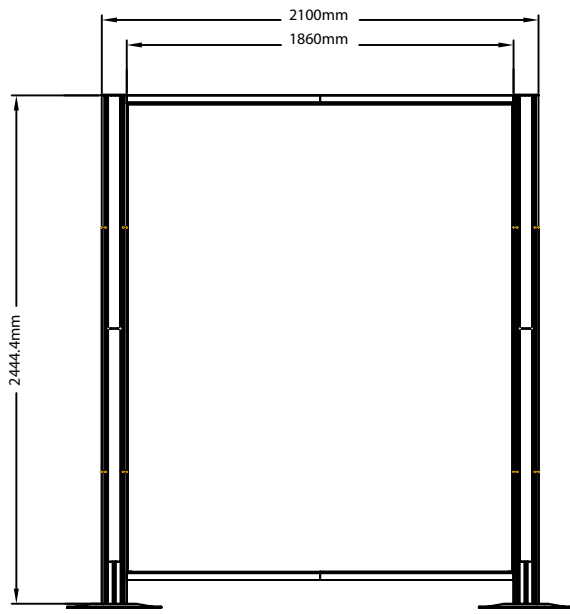

M 1350

Graphic Dimensions

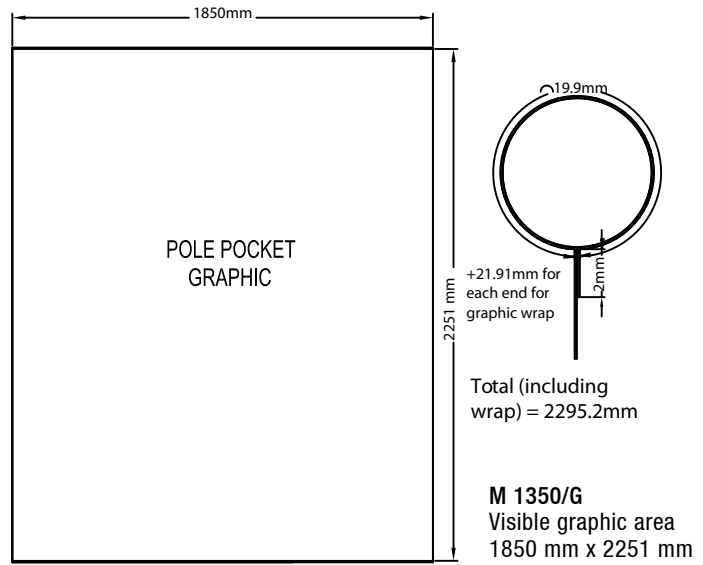

Supplied without panels, inside dimensions correspond to banner size. Special versions on request.

ACCESSORIES

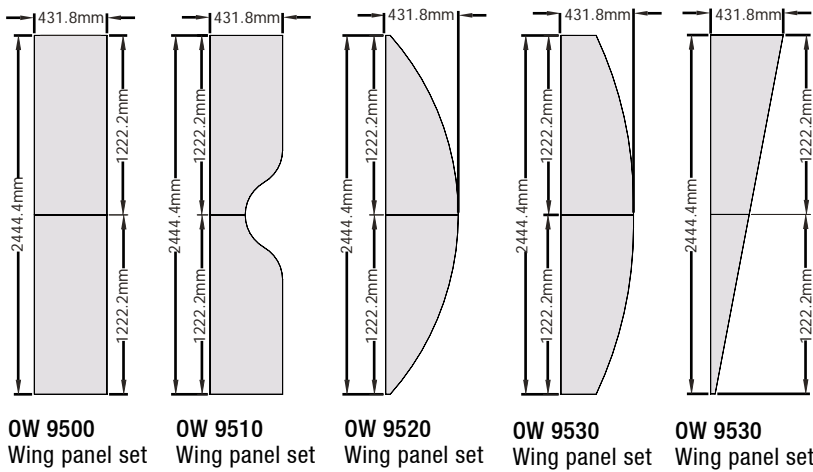

OW 9500
Wing panel set

OW 9510
Wing panel set

OW 9520
Wing panel set

OW 9530
Wing panel set

OW 9530
Wing panel set

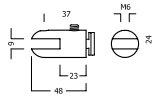

M 1456
Panel hardware set,
8 needed

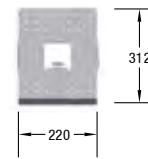

VA 1240
Brochure shelf
universal



M 1438
Cone,
wood, silver



VA 5021
LED arm light



OM 950
Roto-molded case,
2 built-in wheels,
molded-in handles and
telescoping lid
1295 x 686 x 254 mm
gray

TECHNICAL INFORMATION

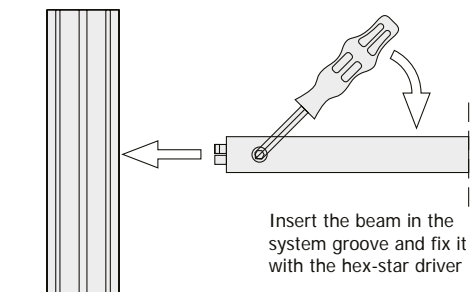
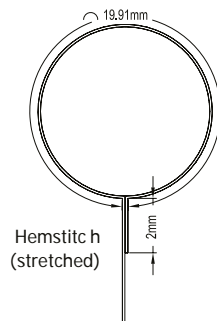
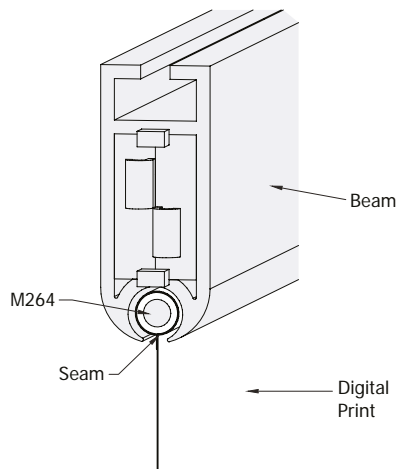

ROLLDOWN WALL- FABRIC DISPLAY

The OCTANORM Rolldown Wall is perfect for fabric graphics and for fast set-up and dismantling. Ideal as an add-on to an existing OCTANORM display or as a stand alone unit.



Design example: RW9000 plus accessories



LED arm light VA5021



Rolldown wall M816/M811



Bottom fastening extrusion

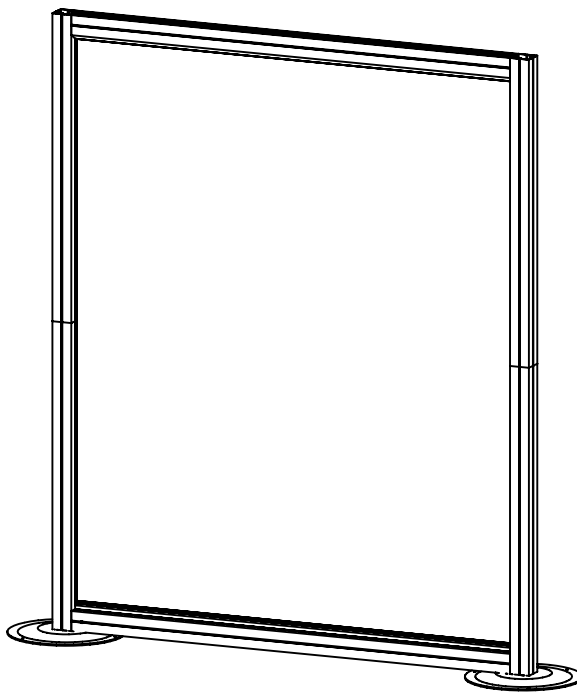
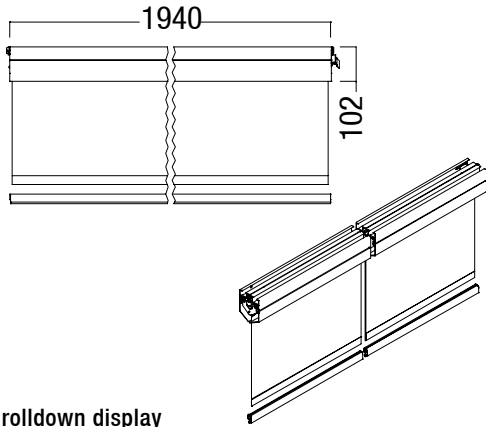

RW9000 Fabric roll-down display
Includes M816 roll-down wall, base plates,
uprights and horizontals
Case not included

ACCESSORIES

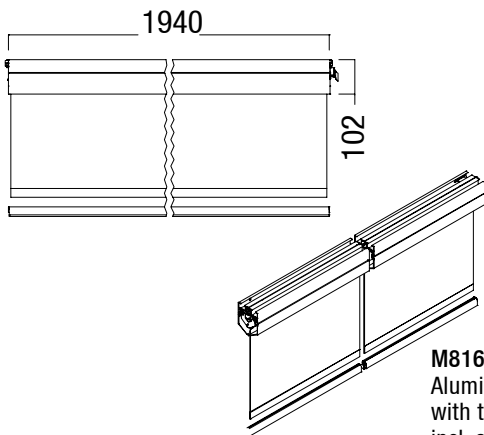

VA 5021
LED arm light

M816
Aluminium
with two tension locks Z961/8,
incl. spring motor with spring shaft
retainers and preceding foil M892,
with bottom fastening extrusion
fabric not included
1940 mm long

TECHNICAL INFORMATION

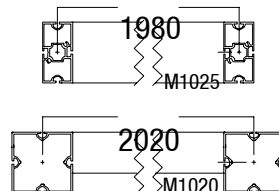
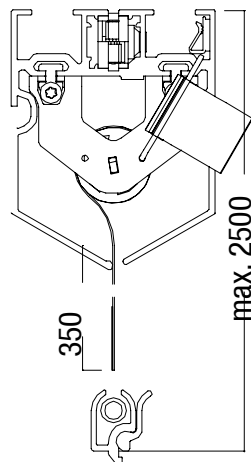

OCTAFABRIC AND OCTAPANEL

OCTAfabric and OCTApanel are thin, elegant free standing displays for an effective double sided presentation. OCTAfabric allows printed fabric to be easily and quickly changed without tools. The system groove allows for the attachment of spotlights, literature racks or display shelves. OCTApanel accepts graphic panels up to 4 mm. The panels can be attached with double sided adhesive tape or magnetic tape (sold separately) that is applied to frame and graphic panel. OCTAfabric and OCTApanel can also be supplied in custom sizes for larger format graphics.



Design example: left: M-Set 1307, 2 x VA 1240 / right: S-Set 1605



OCTANORM system groove and silicone edge graphics (SEG)



Brochure shelf VA 1240



Base plate M 1398

BASIC MODULES



FABRIC DISPLAYS

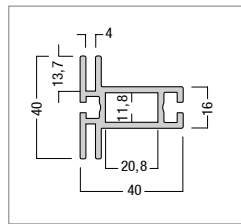
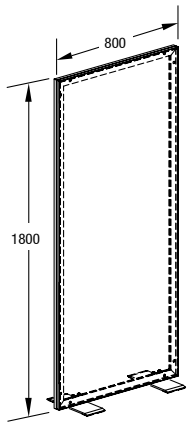

M-Set 1307
OCTAfabric set
straight

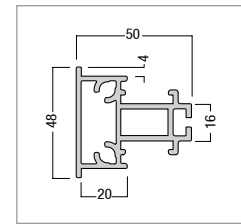
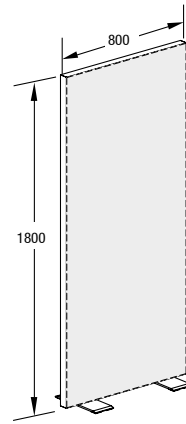

S-Set 1605
OCTApanel set
panel size: 796 x 1796 mm

ACCESSORIES

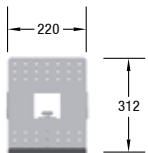

VA 1240
brochure shelf
universal

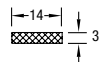

M 1313
silicone welt
100 m



VA 5021
LED arm light

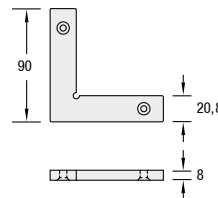

Z 966
Internal corner connector
for S 1605, aluminium

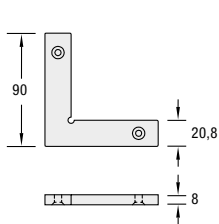

Z 966/S
Internal corner connector
for OCTAfabric

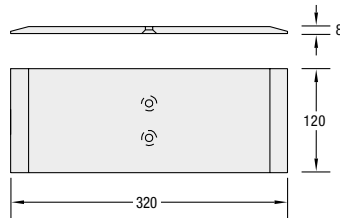

M 1398
Base plate steel
for M-Set 1307
incl. screw set M8 x 60

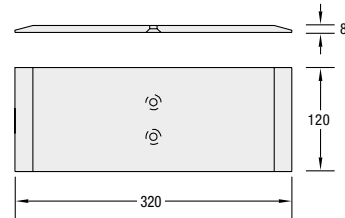

M 1399
Base plate steel
for S-Set 1605
incl. screw set M8 x 45

TECHNICAL INFORMATION

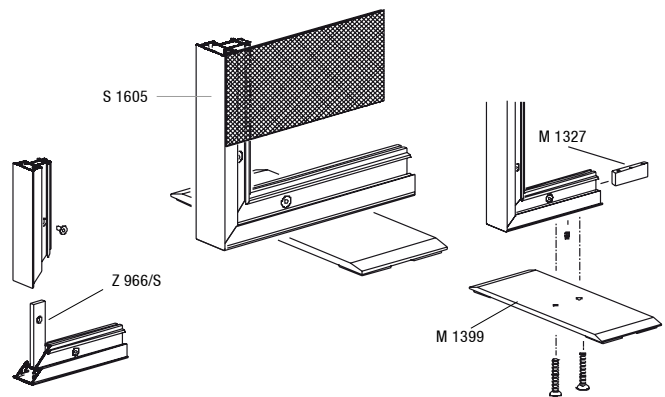
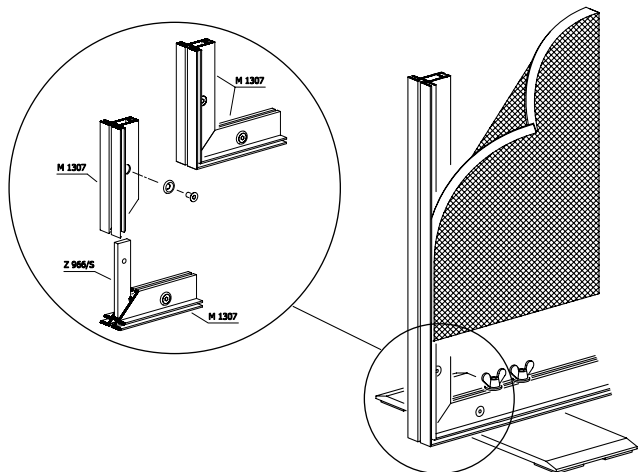

OCTAWALL-PANEL DISPLAY

OCTAwall is the fast and flexible frame construction for elegant exhibition and partition walls. Wall frame construction with solid connections using OCTANORM tension locks. Extremely fast set-up and dismantling. Cable management inside the frames is optional. Easy mounting and dismantling of wall panels with hook-and-loop tape.



Design example: OW9000 plus accessories. Monitor not included



LED arm light VA5021

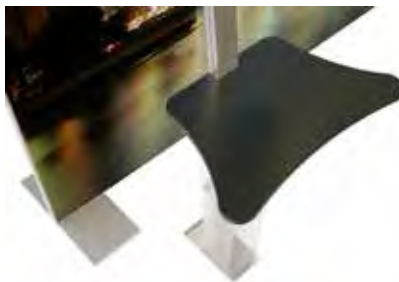

Workstation OW9560



Base plate M1953

Frame Dimensions

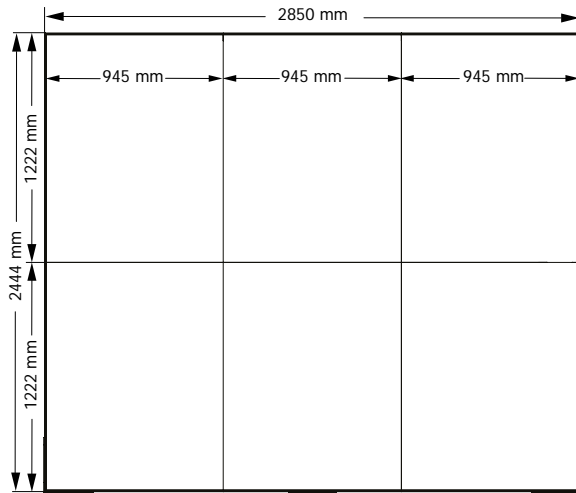

OW9000
Panel wall system display

Graphic Dimensions

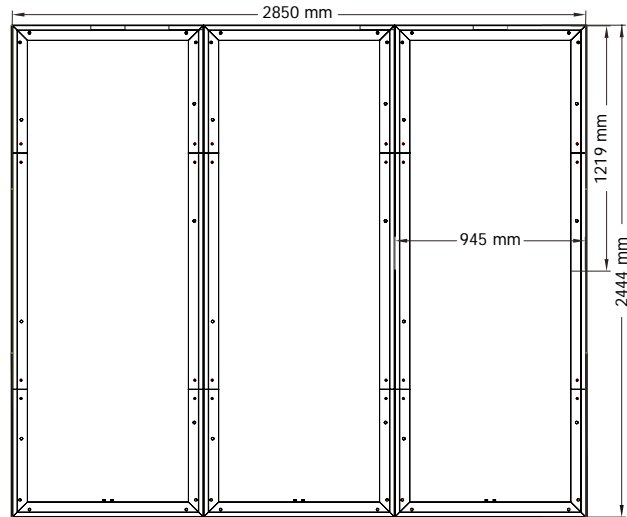

OW9000/G
Graphics

ACCESSORIES

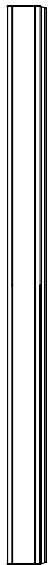

C404K
LED light kit
with C404

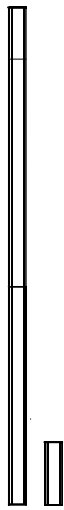

W910
Cover extrusion



OW9560
Workstation

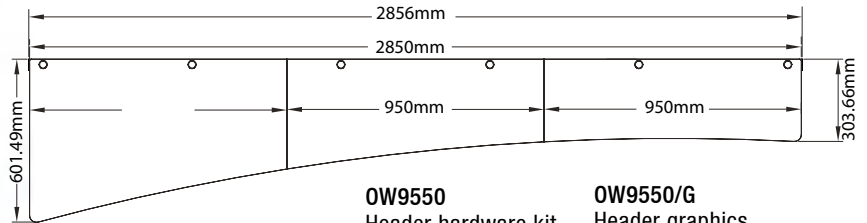

OW9550
Header hardware kit

OW9550/G
Header graphics
3 panels



OW950
Roto-molded case.
2 built-in wheels,
molded-in handle and
telescoping lit
1295 x 686 x 254 mm
gray



VA5021
LED arm light

TECHNICAL INFORMATION

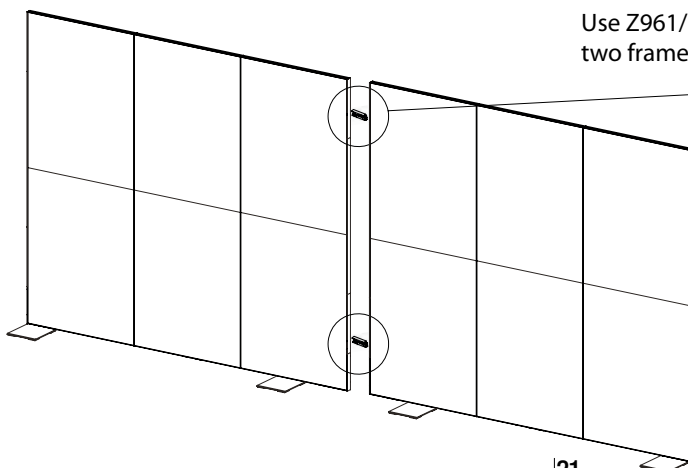

Use Z961/13.00 to lock
two frame sections together

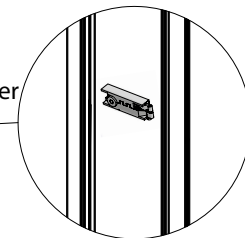

OCTAWALL II - PANEL DISPLAYS

OCTAwall is the fast and flexible frame construction for elegant exhibition and partition walls. Wall frame construction with solid connections using OCTANORM tension locks. Extremely fast set-up and dismantling. Cable management inside the frames is optional. Easy mounting and dismantling of walls and panels with hook-and-loop tape.



Design example: OW9001 plus accessories



LED arm light VA5021



Panel retainer M1456.39



Base plate M1953

Frame Dimensions

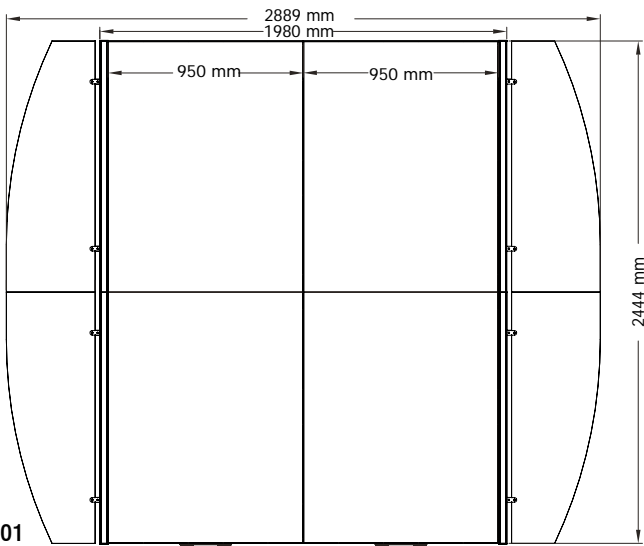

Graphic Dimensions

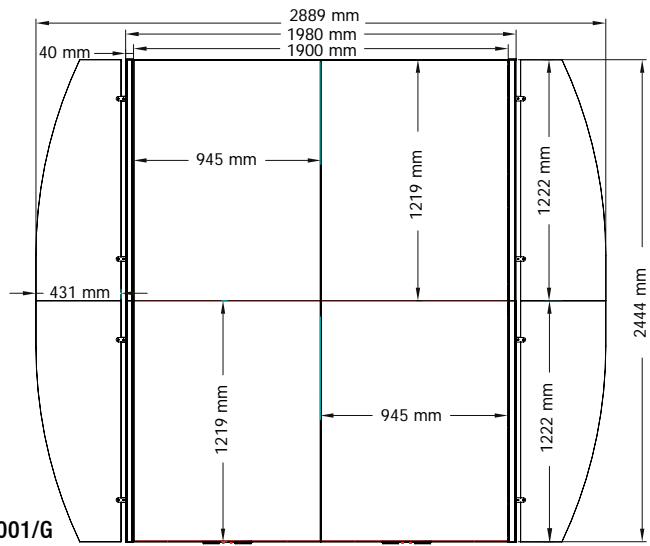

OW9001
Panel wall system display

OW9001/G
Graphics

ACCESSORIES

*Wing panel sets are sold with left and right panels.

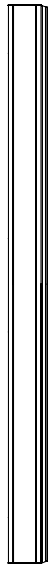

C404K
LED light kit
with C404

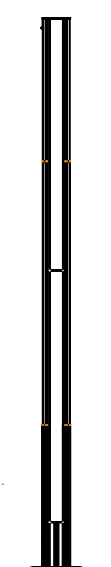

OM920
M215 LED
post kit



OW9560
Workstation

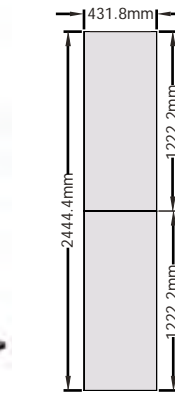

OW9500
Wing panel set

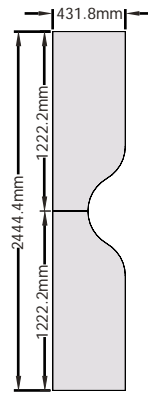

OW9510
Wing panel set

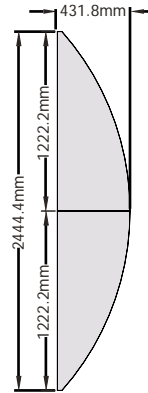

OW9520
Wing panel set

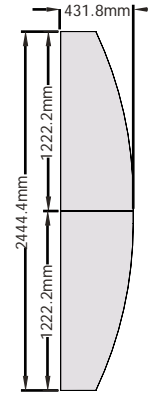

OW9530
Wing panel set

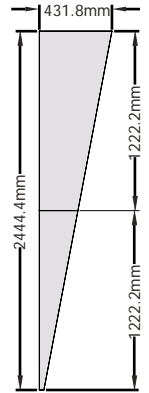

OW9540
Wing panel set

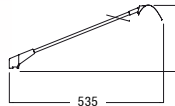

VA5021
LED arm light

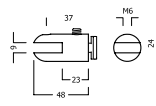

M1456
Panel hardware set
8 needed

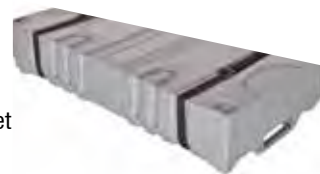

OM950
Roto-molded case,
2 built-in wheels,
molded-in handle and
telescoping lid
1295 x 686 x 254 mm
gray

TECHNICAL INFORMATION

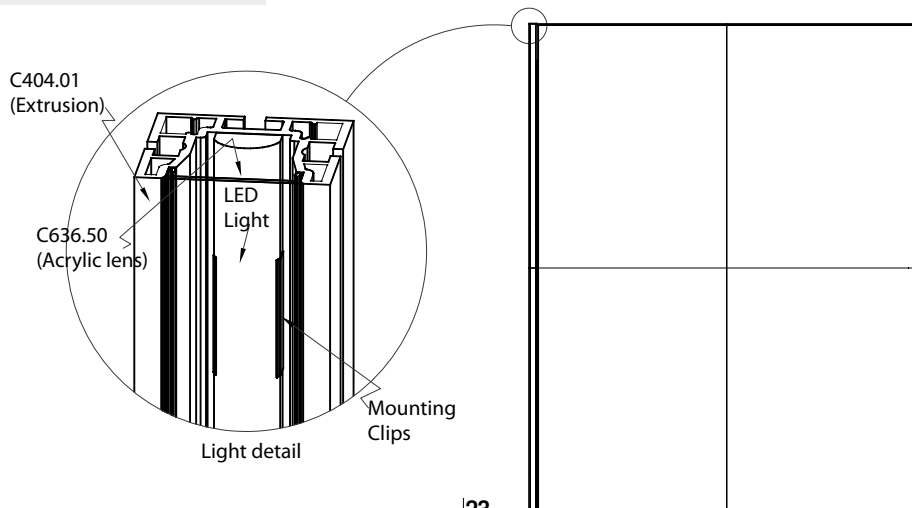

OCTAPOLE BANNER SYSTEM

OCTApole is the ultimate key to successful graphic displays. This ingenious display system offers incredible versatility and an endless range of applications. With an extrusion based on the telescopic principle, OCTApole is easy to adjust in height, allows double-sided exposure and is very easy to mount. The idea display medium! Extrusions can also be attached to the ends to provide additional flexibility in adding monitors, workstations, etc.



Design example: OP 200, 2 x VA 5020



LED arm light VA5021



Continuously height adjustable



Telescopic upright OP150.01/USA <!-- Generator: Adobe Illustrator 18.1.1, SVG Export Plug-In -->

BASIC MODULES

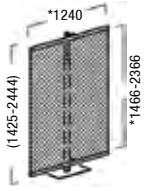

OP 900
Banner set straight
1 telescopic upright and 2 beam extrusions
1240 mm long, incl. 1 base plate

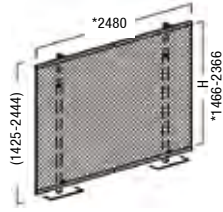

OP 903
Banner set straight
2 telescopic uprights and 4 beam extrusions
1240 mm long, incl. 2 base plates

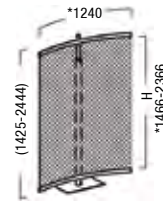

OP 901
Banner set curved concave
1 telescopic upright and 2 beam extrusions
1240 mm long, incl. 1 base plate

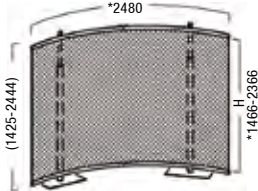

OP 904
Banner set curved concave
2 telescopic uprights and 4 beam extrusions
1240 mm long, incl. 2 base plates

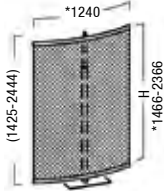

OP 902
Banner set curved convex
1 telescopic upright and 2 beam extrusions
1240 mm long, incl. 1 base plate

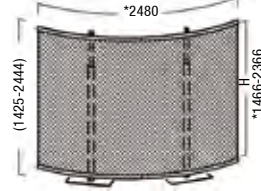

OP 905
Banner set curved convex
2 telescopic uprights and 4 beam extrusions
1240 mm long, incl. 2 base plates

* fabric dimensions

Supplied without graphic panels. Special dimensions on request.

ACCESSORIES

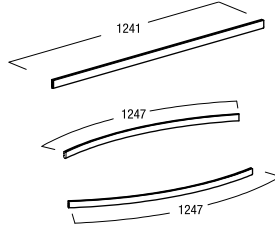

Beam (M 1354.01/USA)
OP 181.01/USA beam straight
OP 183.01/USA beam curved concave
OP 185.01/USA beam curved convex

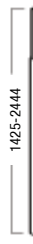

OP 150.01/USA
Telescopic upright adjustable, 40/60 mm, aluminium



OP 158
Adaptor top with fixing screw 70 mm



OP 160
Adaptor bottom with fixing screw 60 mm



OP 155
Base plate, steel, silver powder-coated



VA5021
LED arm light

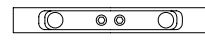

Z977.90 splice

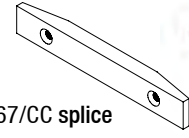

Z967/CC splice

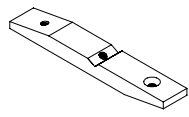

Z697/CS serpentine curve



M 1354.01/USA
Aluminium 5000 mm



OP 950
Transport case for all sets

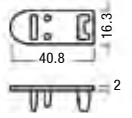

M 1365/K
End cap plastic for M 1356

TECHNICAL INFORMATION

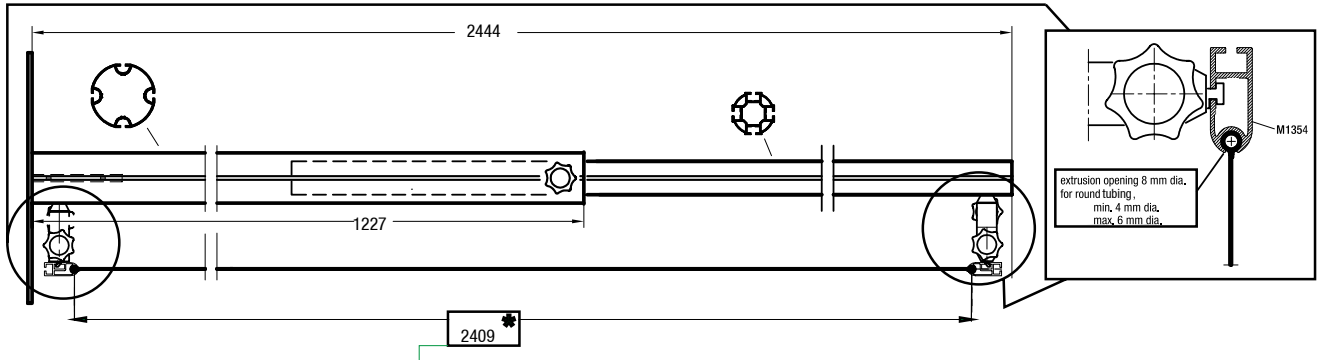

* fabric dimensions =	Total Fabric Area 1240mm W x 2409mm H	Visible Graphic Area 1240mm W x 2366mm H
-----------------------	--	---

VARIO d4 - STRAIGHT AND CURVED

The classical pop-up display – a perfect partner for large-sized motifs. Vario d4 is sturdy, easy to set up and stores away quickly in the transport case.



Design example: VA 4823 P1 (left), VA 4723 P1 (right)



Case can be used as counter with graphic



Quickly packed in transport case VA 8056



Graphics can be changed in seconds

BASIC MODULES

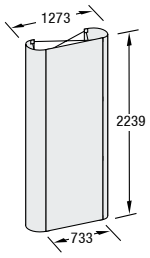

VA 4713 P1
straight, for 1 panel

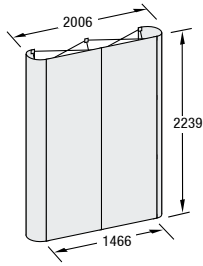

VA 4723 P1
straight, for 2 panels

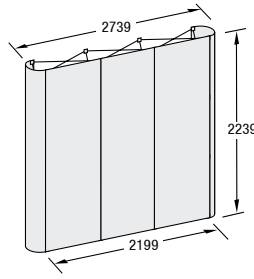

VA 4733 P1
straight, for 3 panels

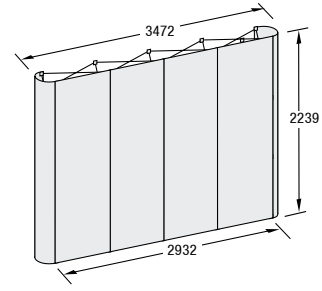

VA 4743 P1
straight, for 4 panels

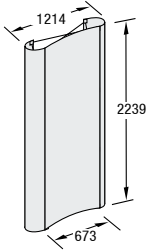

VA 4813 P1
curved, for 1 panel

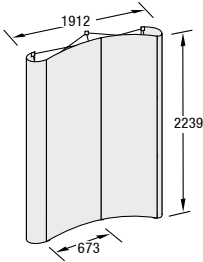

VA 4823 P1
curved, for 2 panels

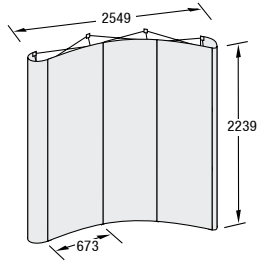

VA 4833 P1
curved, for 3 panels

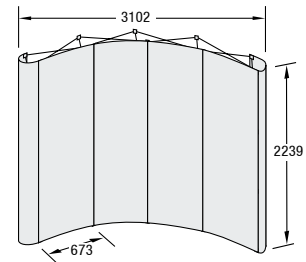

VA 4843 P1
curved, for 4 panels

All systems are supplied excluding graphic panels. Package solution includes structure, spotlights and transport case. For other set ups please contact your local OCTANORM display partner.

ACCESSORIES

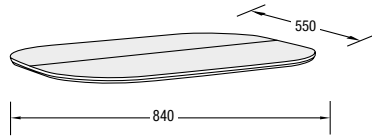

VA 8069
Counter top
for transport case
VA 8056, white,
foldable



VA 5035
Magnetic strip
self-adhesive,
30 m

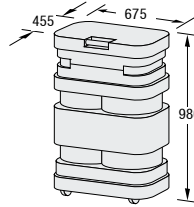

VA 8056
transport case

TECHNICAL INFORMATION

Straight version

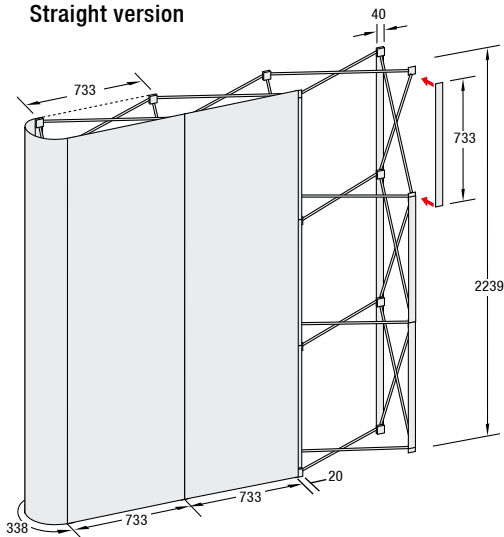

Curved version

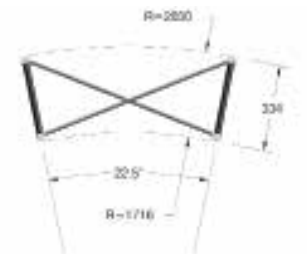
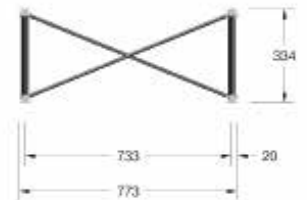
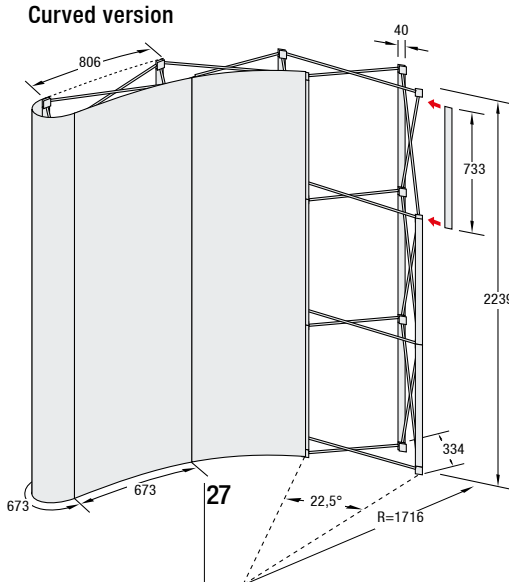

VARIO d400 STRAIGHT

Stability and high efficiency – you get it all in one display. While your message is clearly visible on the panels of this display, its design is the perfect frame for your trade show presence. Handy accessories complete the presentation.



Design example: VA 5723 P1, 2 x VA 1240



Simple attachment of accessories



Transport case VA 8056



Sturdy aluminium tubes and connectors

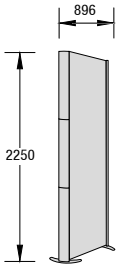

VA 5713 P1
for 1 panel
aluminium extrusions on
both sides, silver anodized,
incl. 1 spot

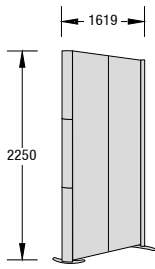

VA 5723 P1
for 2 panels
aluminium extrusions on
both sides, silver anodized,
incl. 1 spot

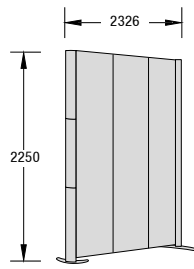

VA 5733 P1
for 3 panels
aluminium extrusions on
both sides, silver anodized,
incl. 2 spots

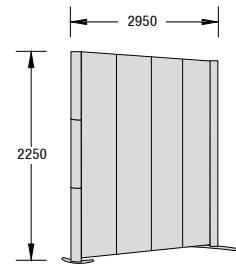

VA 5743 P1
for 4 panels
aluminium extrusions on
both sides, silver anodized,
incl. 2 spots

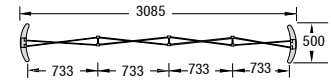
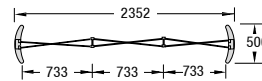
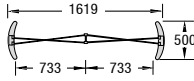
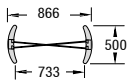

All systems are supplied excluding graphic panels. Package solution includes structure, spotlights and transport case. For other set ups please contact your local OCTANORM display partner.

ACCESSORIES

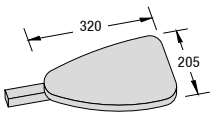

VA 1213
Display shelf
white

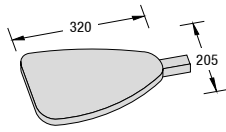

VA 1214
Display shelf
white

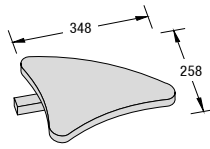

VA 1216
Display shelf
white

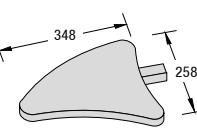

VA 1217
Display shelf
white

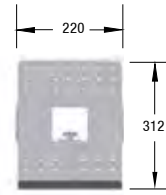

VA 1240
Brochure shelf
universal

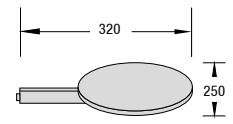

VA 5076
Display shelf
wood, silver

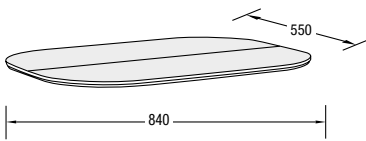

VA 8069
Counter top
for transport case
VA 8056, white,
foldable

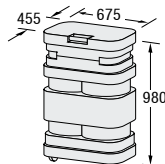

VA 8056
transport
case



VA 5035
Magnetic strip
self-adhesive,
30 m

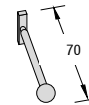

E 275
Bag holder

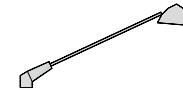

VA 5021
Spotlight halogen
120 W / 230 V



VA 5512
Monitor adaptor
straight

TECHNICAL INFORMATION

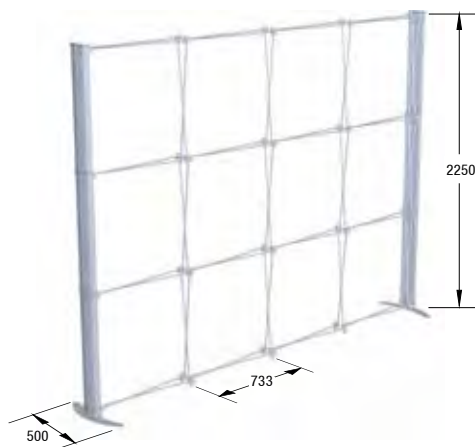

Dimension panel
inside / outside

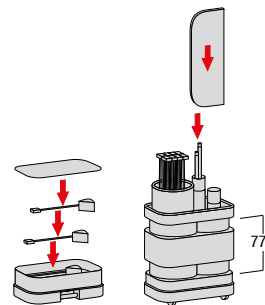
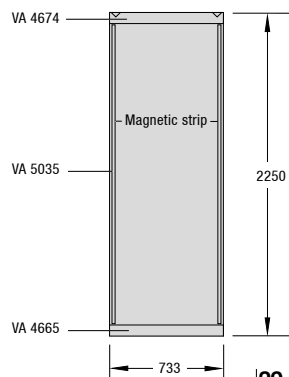

Note: transport case can be used as counter with graphic

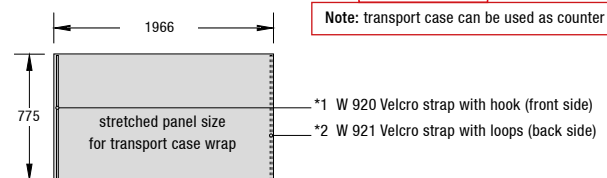

VARIO d400 CURVED

The aluminium side extrusions allow for endless possibilities to customize and expand your display. Create your individual presentation in next to no time by adding literature holders, display shelves and monitors. Vario d400 is a wonderful display for your advertising and P.O.S. presence as well as for merchandise presentation. Transport cases and lighting are included in the sets.



Design example: VA 5833 P1, VA 1240, VA 1213, E 275, E 185 (without monitor)



d400 package in transport case VA 8056



Display shelf VA 1214



Brochure shelf VA 1240

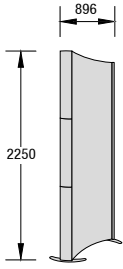

VA 5813 P1
for 1 panel
aluminium side extrusions,
silver anodized, incl. 1 spot

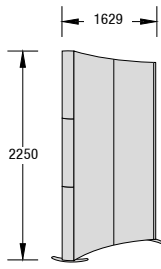

VA 5823 P1
for 2 panels
aluminium side extrusions,
silver anodized, incl. 1 spot

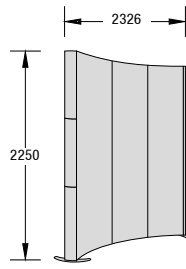

VA 5833 P1
for 3 panels
aluminium side extrusions,
silver anodized, incl. 2 spots

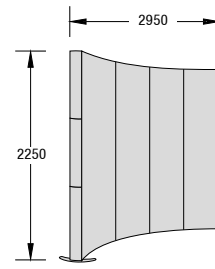

VA 5843 P1
for 4 panels
aluminium side extrusions, silver
anodized, incl. 2 spots

All systems are supplied excluding graphic panels. Package solution includes structure, spotlights and transport case. For other set ups please contact your local OCTANORM display partner.

ACCESSORIES

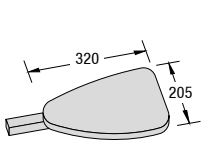

VA 1213
Display shelf
white

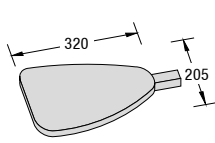

VA 1214
Display shelf
white

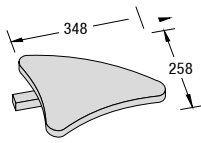

VA 1216
Display shelf
white

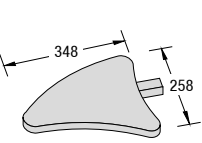

VA 1217
Display shelf
white

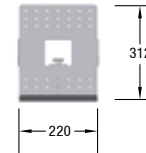

VA 1240
Brochure shelf
universal

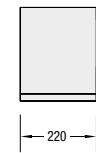

VA 5036
Brochure shelf
left

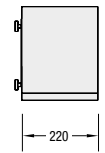

VA 5032
Brochure shelf
right

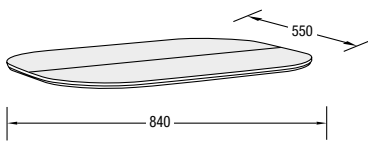

VA 8069
Counter top
for transport case
VA 8056, white,
foldable

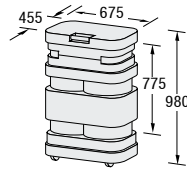

VA 8056
transport
case



VA 5035
Magnetic strip
self-adhesive,
30 m

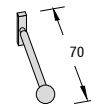

E 275
Bag holder

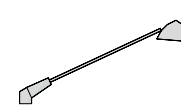

VA 5021
Spotlight halogen
120 W / 230 V



VA 5513
Monitor adaptor
curved

TECHNICAL INFORMATION

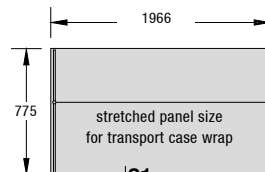
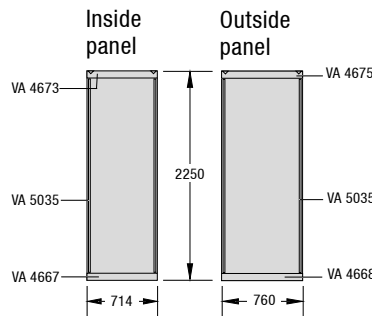
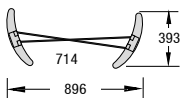
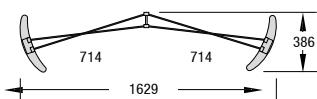
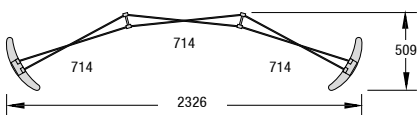
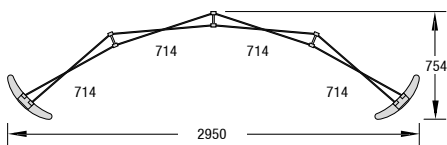

*1 W 920 Velcro strap with hook (front side)
*2 W 921 Velcro strap with loops (back side)

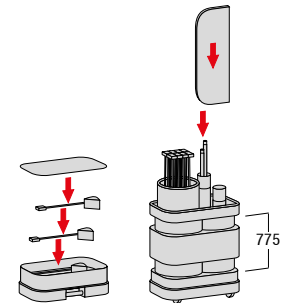

Note: transport case can be used as counter with graphic



Package solutions includes hangers and hooks for inside panels only, for outside panels additional components are needed.

VARIO d100 ROLL UP

Compact in size and quick and effective in use, this system enables graphic panels to be simply rolled out of the base unit within seconds, making it ideal for use at frequently changing venues. The optional spotlight also fits into the practical carrying bag. Available in two standard widths of 840 and 1000 mm, multiple units can be joined by alignment connectors to provide a back wall with large format graphics.

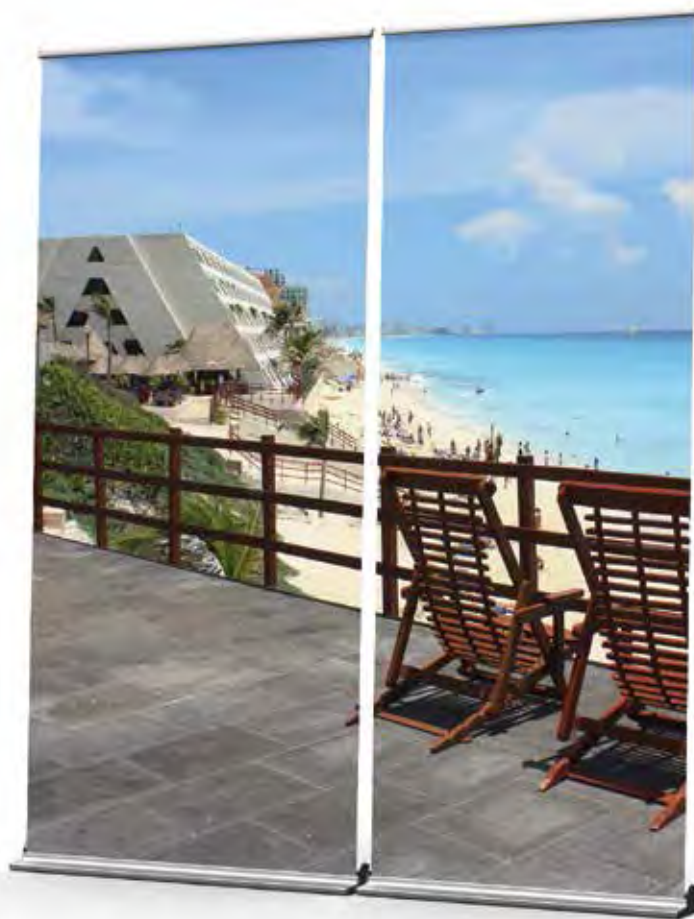

Design example: 1 x VA 9831, 1 x VA 9832



LED arm light VA 5021



Detail display design

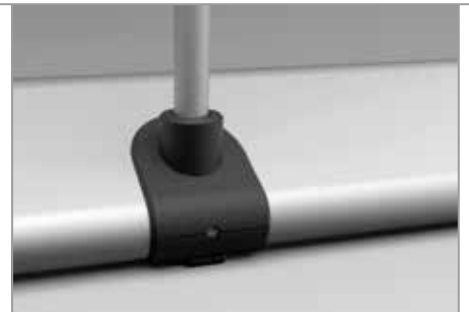

Roll up on both sides for double exposure

SINGLE SIDED



VA 9832
840 x 2300 mm
with transport bag

VA 9822
840 x 2300 mm
without transport bag

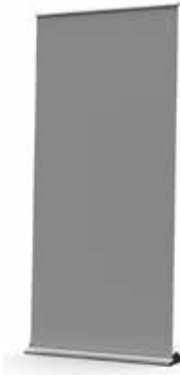

VA 9831
1000 x 2300 mm
with transport bag

VA 9821
1000 x 2300 mm
without transport bag

DOUBLE SIDED



VA 9834
840 x 2300 mm
with transport bag

VA 9824
840 x 2300 mm
without transport bag



VA 9833
1000 x 2300 mm
with transport bag

VA 9823
1000 x 2300 mm
without transport bag

ACCESSORIES



VA5021
LED arm light



VA 9900, 840 mm
VA 9901, 1000 mm
Transport bag
for single sided Roll Ups,
black-grey



VA 9800
Transport bag
for VA 9834 and VA 9824,
840 mm



VA 9801
Transport bag
for VA 9833 and VA 9823,
1000 mm



VA 4648
Alignment connector

TECHNICAL INFORMATION

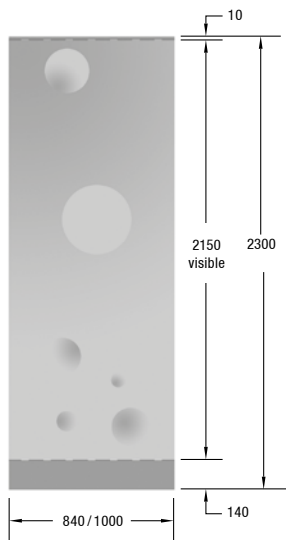

VARIO d5 STRING PROMOTION DISPLAY

With a space requirement of only 315 mm in depth, Vario d5 String fits nicely almost everywhere. Graphics are attached by means of a clamping extrusion. Vario d5 String is available in 300, 600, 800 and 1000 mm widths; special sizes are available on request. This display is a perfect solution for quick and easy promotion and allows for a professional and efficient presentation.



Design example: VA 8300, VA 5093, Panel recommendation: banner, max. thickness 0.25 mm



Spotlight VA 5093



Assembly without tools



Transport bag

BASIC MODULES

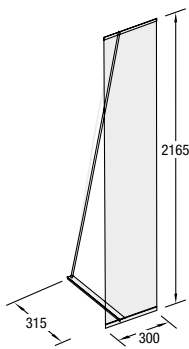

VA 8303
300 x 2165 mm

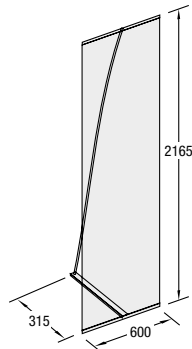

VA 8301
600 x 2165 mm

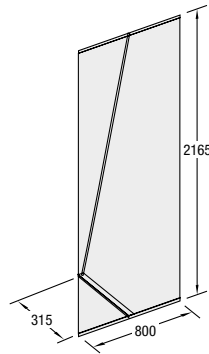

VA 8300
800 x 2165 mm

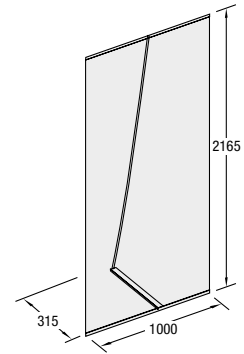

VA 8302
1000 x 2165 mm

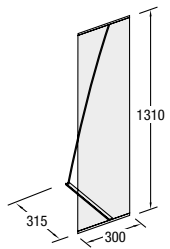

VA 8313
300 x 1310 mm

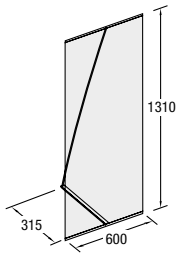

VA 8311
600 x 1310 mm

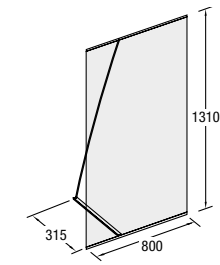

VA 8310
800 x 1310 mm

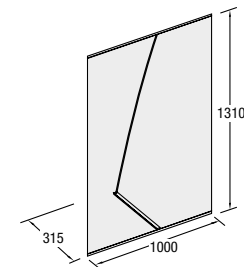

VA 8312
1000 x 1310 mm

Supplied without panels, dimensions correspond to panel size.

ACCESSORIES

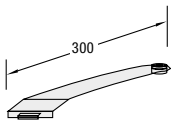

VA 8401
Base part
steel, 3 mm



VA 9077
Clamping pole
2213 mm

(no illustration)

VA 9076
Clamping pole
1335 mm

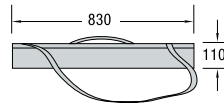

VA 8604
Transport bag for
d5 String, 300 mm,
600 mm and 800 mm

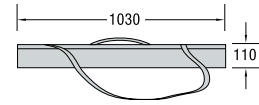

VA 8603
Transport bag for
d5 String, 1000 mm



VA 5021
LED arm light



Top/bottom clamping extrusion, silver
VA 8017 300 mm
VA 8015 600 mm
VA 8014 800 mm
VA 8016 1000 mm



VA 9853
End cap
right



VA 9854
End cap
left

TECHNICAL INFORMATION

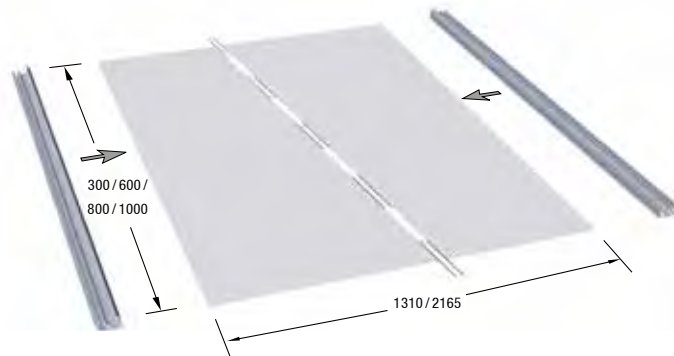
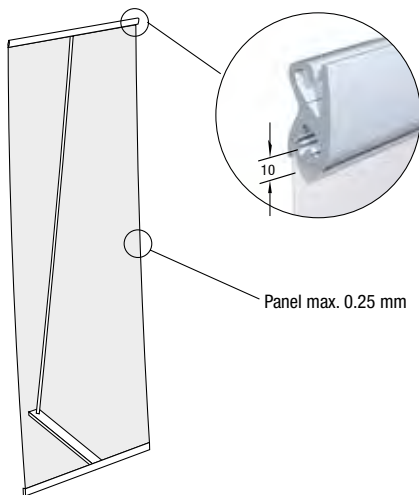

Paper or banner material 0.1 - 0.25 mm

VARIO EVENT RECTANGLE

Thanks to the variable "VARIO EVENT SERIES" made by OCTANORM, every outdoor event becomes a highlight. The unique and timeless design adds to the distinctive character of your outdoor presentation. There is a wide scope for design as the system offers endless configuration and combination possibilities. With four uprights, the rectangle is solidly constructed. Graphics and banners are easily attached for a perfect outdoor presentation of your sales message.



Design example: VA 1314, VA 1310, VA 1315, 2 x E 275



Partition wall set VA 1316



Maximize your message with fabric walls



Case with castors for basic module offers easy packaging and transport



VA 1314
Rectangle, 4 uprights
with fabric roof



VA 1304
Rectangle, 4 uprights
without fabric roof

ACCESSORIES

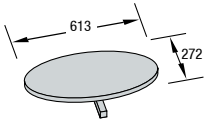

VA 1211
Display shelf
white

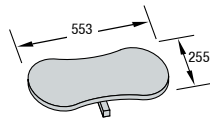

VA 1212
Display shelf
white

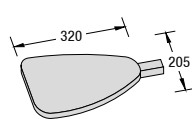

VA 1213
Display shelf
white

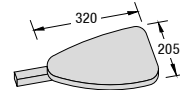

VA 1214
Display shelf
white

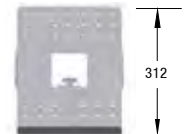

VA 1240
Brochure shelf
universal

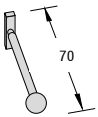

E 275
Bag holder



VA 1311
Strap kit for panels

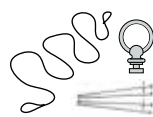

VA 1340
Suspension kit for 1 upright

All OCTANORM accessories may be used with the vario event system.

TECHNICAL INFORMATION

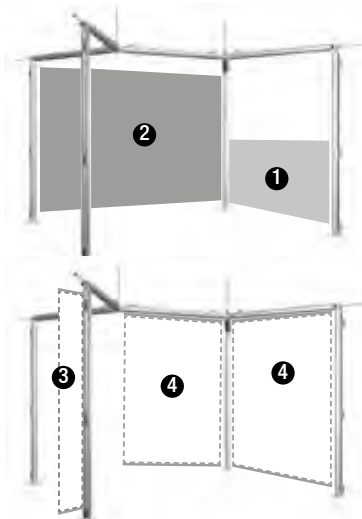
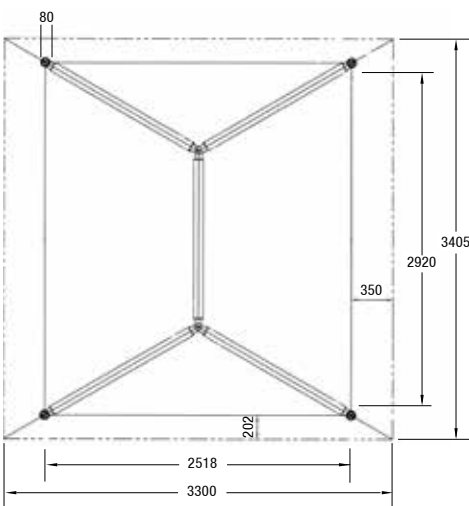

PANEL SIZES:

1 W 2430 x H 1010 mm

2 W 2830 x H 2020 mm

3 W 1348 x H 200 - 2020 mm

4 W 350 x H 200 - 2020 mm

VARIO EVENT TRIANGLE

The new triangular design is an absolute recommendation. Its basic construction clearly stands out from the crowd of ordinary “tents”. With additional graphics and banners, the path is clear for successful outdoor advertising. “VARIO EVENT SERIES” also leaves a perfect impression at sports events. Numerous accessories such as display and brochures shelves etc. complete the product line.



Design example: VA 1313, VA 1315, VA 1240



Banner set VA 1315 easily inserted with welt 6 mm



Fabric wall attached with suspension kit VA 1311



Banner set VA 1315



VA 1313
Triangle, 3 uprights
with fabric roof



VA 1303
Triangle, 3 uprights
without fabric roof

ACCESSORIES

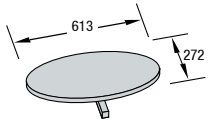

VA 1211
Display shelf
white

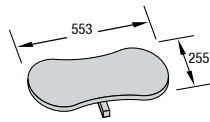

VA 1212
Display shelf
white

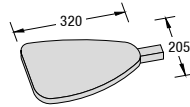

VA 1213
Display shelf
white

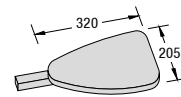

VA 1214
Display shelf
white

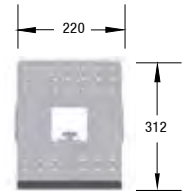

VA 1240
Brochure shelf
universal

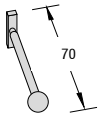

E 275
Bag holder

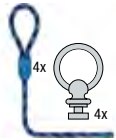

VA 1311
Strap kit for panels

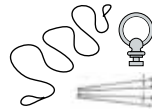

VA 1340
Suspension kit for 1 upright

All OCTANORM accessories may be used with the vario event system.

TECHNICAL INFORMATION

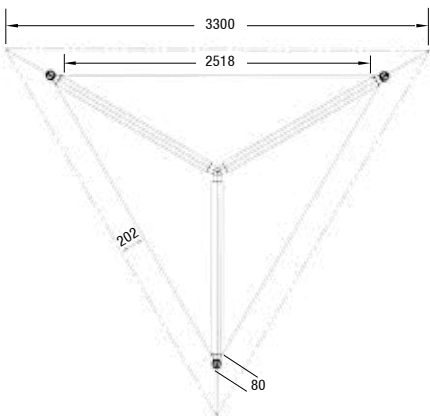

PANEL SIZES:

❶ W 2430 x H 2020 mm



❸ W 350 x H 200 - 2020 mm

❹ W 1348 x H 200 - 2020 mm

OCTACOUNTER

THE OCTAcouter is impressively simple to assemble! Its modern design and robust construction allows this counter to be used in a wide variety of ways at exhibitions, marketing events and product demonstrations. The side panels just unfold into position without the need for tools. The interior shelf offers extra storage for literature or supplies and lockable doors are available. Where larger reception counters are needed, OCTAcouter modules can simply be linked together.



Design examples: Q400.33/USA (panel) and Q401.33/LED (illuminated)



Inside shelf



Door set



Transport case

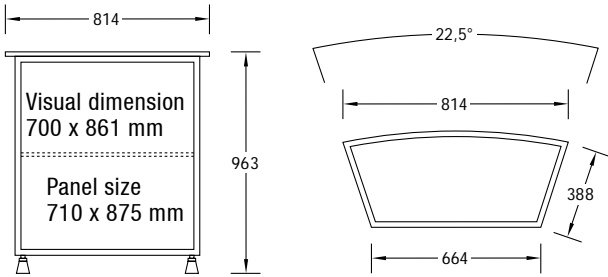

Q400.33/USA
Panel counter, black,
case included

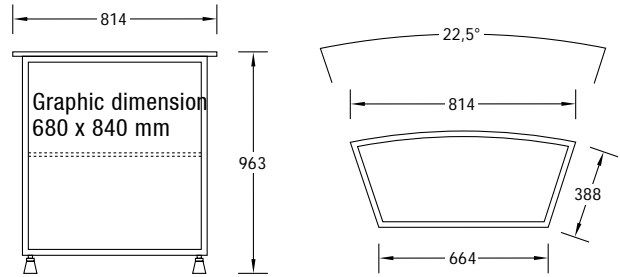

Q401.33/LED
Fabric front, black
illuminated,
case included

Q401.33/USA
Fabric front, black
case included

ACCESSORIES

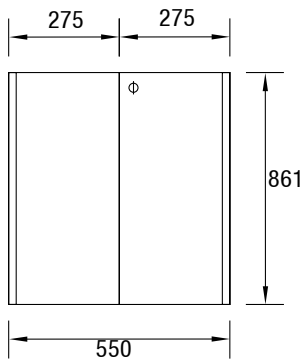

Q411.33/USA
Door set,
black



Q501.33/USA
Roto-molded from rugged polyethylene,
two wheels, two heavy duty straps with
quick release buckles, molded-in handles,
telescoping lid
1143 x 838 x 279 mm
gray

TECHNICAL INFORMATION

Additional information:

- Extrusions: Aluminium matt, clear, silver anodized
- Counter top: Laminate, 16mm
- Side panels: Melamine, 16mm
- Shelf base: Melamine, 16mm (below and center)
- Front panel: Laminate, 3.2mm
- Feet: Height adjustable (approx. 10mm)
- Set of doors: Two melamine double doors, tool-free assembly, lockable, two keys
- Lighting: LED strips

Mounting variants:

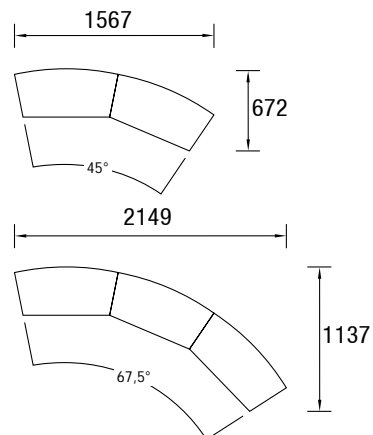

VARIO PROMOTION COUNTER

Attract, engage and motivate your customers with our promotional counters. Available in a straight or curved design the aluminium ends with an OCTANORM groove allows you to connect literature racks, shelves or bag holders. Graphics fix to the front with magnetic tape and the top just drops into position. Optional interior shelves are also available.



Design example: VA 2210, VA 1213, VA 1214



Display shelf VA 1214



Brochure shelf VA 1240



The counter is supplied with a nylon bag



VA 2200
Straight counter
incl. transport bag
panel size: 737/673 x 945 mm



VA 2210
Curved counter
incl. transport bag
panel size: 737/673 x 945 mm

All counters supplied without graphic panel. Hanger and kicker are included.

ACCESSORIES

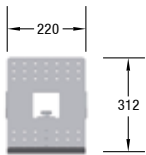

VA 1240
Brochure shelf
universal

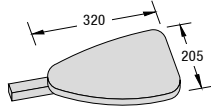

VA 1213
Display shelf
white

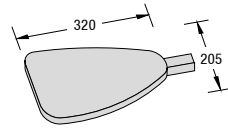

VA 1214
Display shelf
white

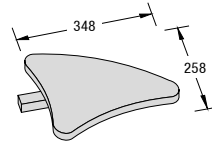

VA 1216
Display shelf
white

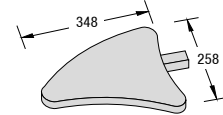

VA 1217
Display shelf
white



Internal shelf
VA 2224 for counter VA 2200
VA 2225 for counter VA 2210

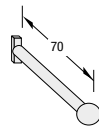

E 275
Bag holder

TECHNICAL INFORMATION

SET-UP STEPS FOR VARIO COUNTER

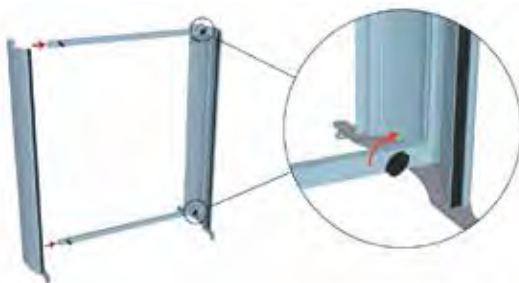

Step 1

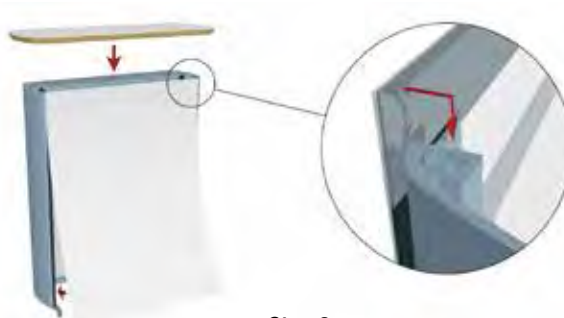

Step 2

VARIO d2 MONITOR PRESENTATION

Monitor adaptors can be mounted on the front or side of an upright or between the beams. They accept monitors with standard vesa patterns and are quick and easy to attach to the system groove. Cable management and safety can be easily achieved with our accessories.



Design example: Individual part list on request



Extrusion clip M 1488 for cable management



Monitor adaptor E 185 and cable way M 1485



Monitor adaptor E 186 and 2 x beam Z 415

BASIC MODULES

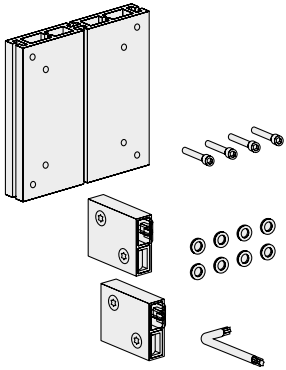

E 185
Monitor adaptor

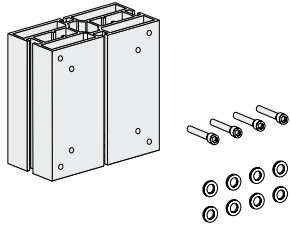

E 184
Monitor adaptor
for OCTAwall mobil 40 fabric

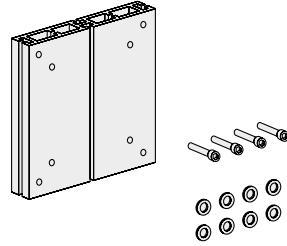

E 186
Monitor adaptor

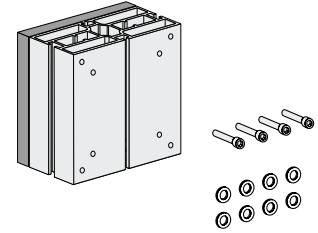

E 187
Monitor adaptor
for OCTAwall mobil 60 fabric

ACCESSORIES

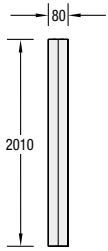

M 1049
Upright square
4 grooves

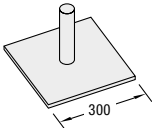

M 1406
base plate
silver-grey

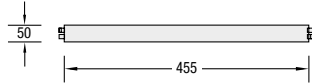

Z 415
Beam, tension lock on both sides,
additional beams on request

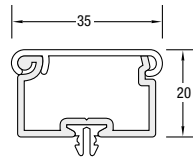

M 1485
Cable way
aluminium, 2480 mm

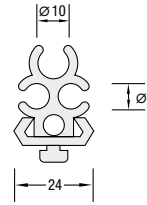

M 1488
Extrusion clip
plastic

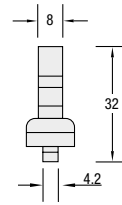

M 1035
End plate
for M 1049

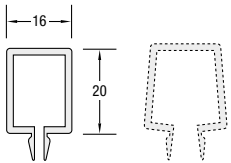

E 460
Extrusion clip
plastic, 5000 mm

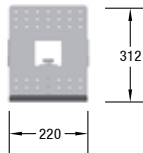

VA 1240
Brochure shelf
universal

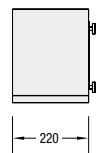

VA 5036
Brochure shelf
left

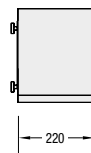

VA 5032
Brochure shelf
right

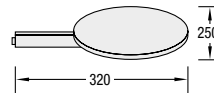

VA 5076
Display shelf
wood, silver

TECHNICAL INFORMATION

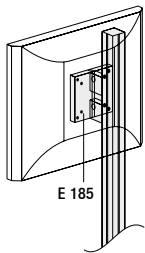

E 185

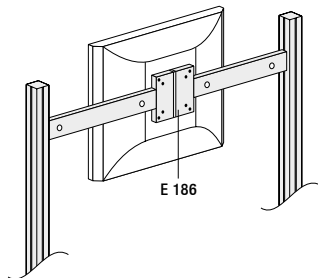

E 186

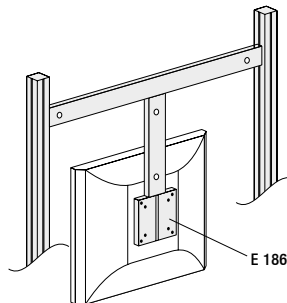

E 186

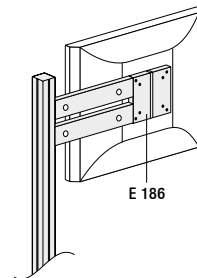

E 186

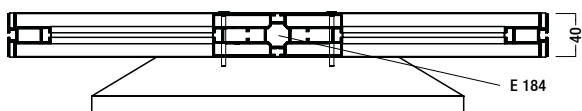

E 184

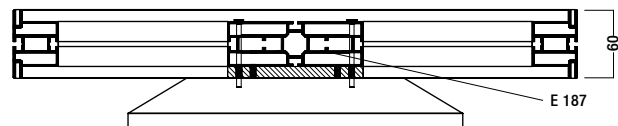

E 187

MONITOR PRESENTATIONS

Present your digital media with our solutions for monitors from 15 - 52". Accessories for literature and graphics complete the range for added value.



Design example: VA 5514 with screen, R 01 with screen, K 01 with screen, VA 5524 with screen



Base plate of monitor stand K 01



Monitor stand set VA 5514



VA 5514 packed in transport case K 0012



15" - 22"

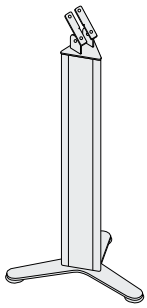

R 01
Monitor stand
adjustable angle 90°-140°

15" - 22"

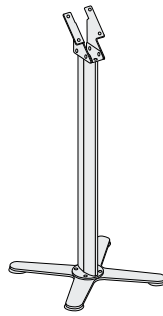

K 01
Monitor stand
45° angle

20" - 32"

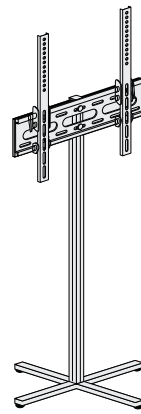

VA 5514
Monitor stand set
with transport case K 0012

36" - 52"

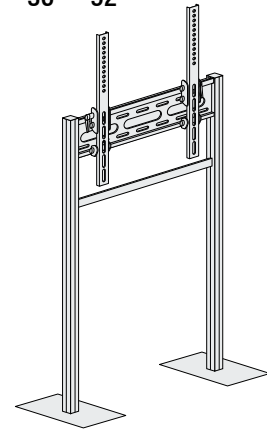

VA 5524
Monitor stand set
without transport case

TECHNICAL INFORMATION

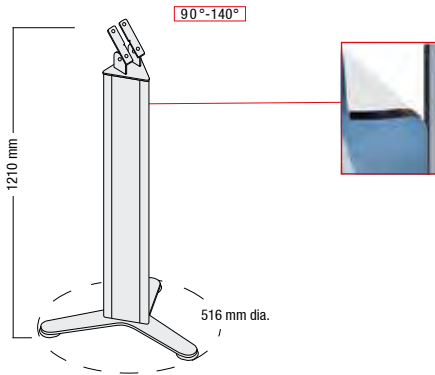

Dimensions and angles of VA 5514

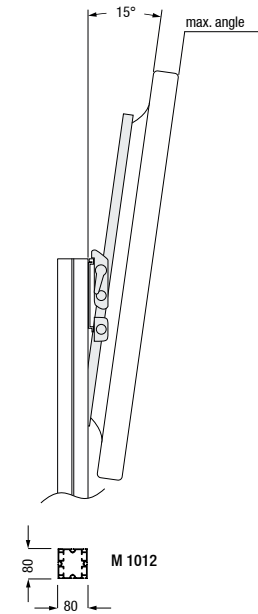
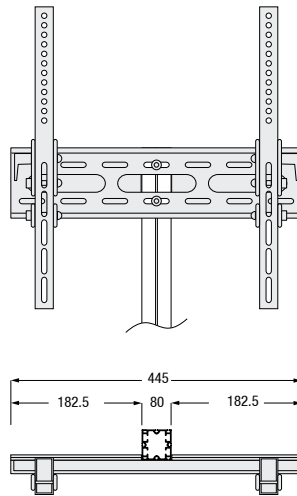

Dimensions and angles of VA 5524

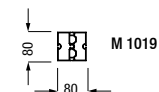
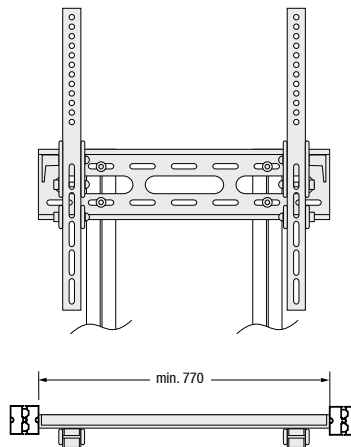
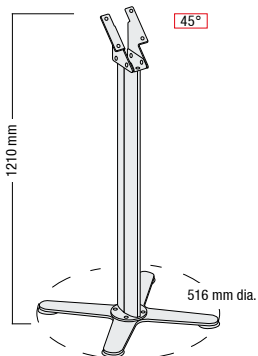

OCTANORM iPad STAND

Two free standing versions are available as well as one that can be connected to the OCTANORM groove. An adjustable hinge allows them to change from portrait to landscape format.



Design example: left: VA 1526, right: VA 1525



Compact packaging and easy to mount



The black coated surface prevents reflection

BASIC MODULES



DIGITAL PRESENTATIONS

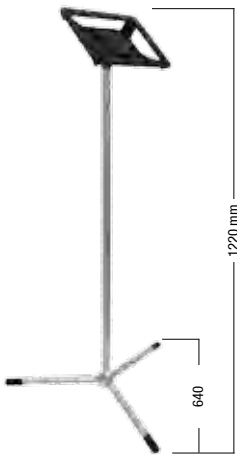

VA 1525
iPad pole
with adjustable hinge

VA 1525A
iPad Air pole
with adjustable hinge

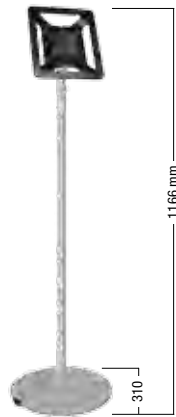

VA 1526
iPad pole
with adjustable hinge

VA 1526A
iPad Air pole
with adjustable hinge



VA 1527
iPad holder
for connection to
75/100 VESA systems



VA 1528
iPad holder
with 75/100 VESA system
and removable
OCTANORM adaptor E 186
(see page 33)

VA 1527A
iPad Air holder
for connection to
75/100 VESA systems

VA 1528A
iPad Air holder
with 75/100 VESA system
and removable
OCTANORM adaptor E 186
(see page 33)

ACCESSORIES



VA 9801
Transport bag
for VA 1525 and
VA 1525A



VA 1533
USB extension cable
5 m, beige



VA 1534
Data and charging cable
for iPad, black



M 1457
Hinged distance piece
for VA 1528, for attachment
to OCTANORM system groove

TECHNICAL INFORMATION



The cable retainer keeps the data and charging cable safe in the frame.



Simply turn the handle and lock the position of the iPad frame.



The hinged distance piece with iPad frame for attachment to OCTANORM system groove.

LITERATURE RACKS

Quality, durable literature racks allow you to present your brochures in style. Freestanding and display mounted versions are ideal for showcasing your literature at events, lobbies or shops.



Design examples: P-L4, P-L3, and P-LB6



MOBILE LITERATURE RACKS



LITERATURE DISPLAYS

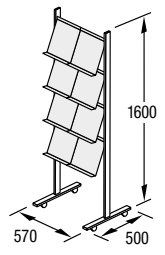

P-8
8 acrylic shelves
with castors

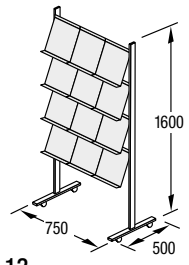

P-12
12 acrylic shelves
with castors

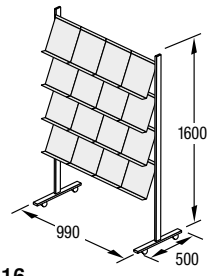

P-16
16 acrylic shelves
with castors

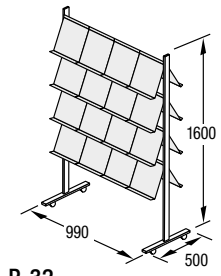

P-32
32 acrylic shelves
with castors

LITERATURE RACKS

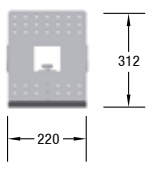

VA 1240
Brochure shelf
universal

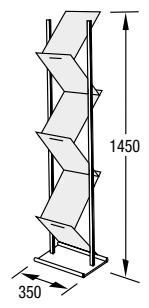

P-ZZ6
6 acrylic shelves

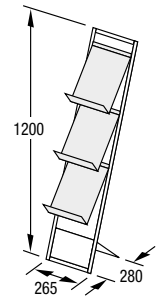

P-3
3 acrylic shelves

PORTABLE LITERATURE RACKS

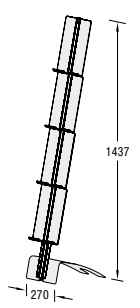

Portable literature rack
with 4 acrylic shelves
VA 8804PW
with transport bag
VA 8842
without transport bag

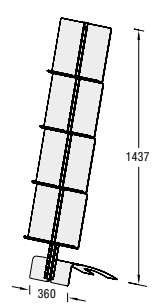

Portable literature rack
with 8 acrylic shelves
VA 8808PW
with transport bag
VA 8882
without transport bag

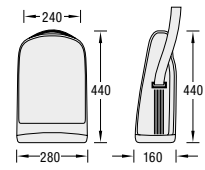

VA 8834
Transport bag
for **VA 8842**

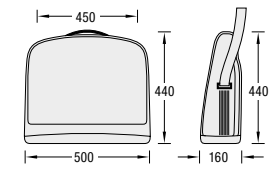

VA 8838
Transport bag
for **VA 8882**

LITERATURE RACKS

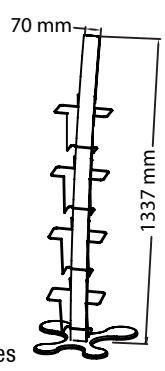

P-L3
Literature rack
with 4 wire shelves
without transport bag

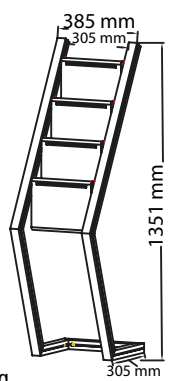

P-L4
Literature rack
with 4 pouches
without transport bag

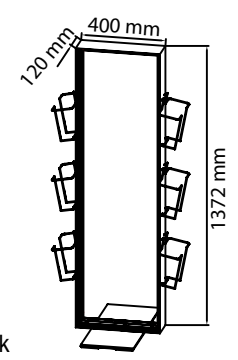

P-LB6
Illuminated
literature rack
(visible graphic dimensions
1386 x 396 mm)
without transport bag

WORKSTATION

Unique and sleek, this dual purpose workstation provides interactive capabilities as well as additional stability to any OCTANORM display. Complete with laminated top and LCD monitor mount, the design adds class to any graphic presentation.



Monitor not included

Design example: OM9560, monitor not included



Shelf



Base plate



Connector

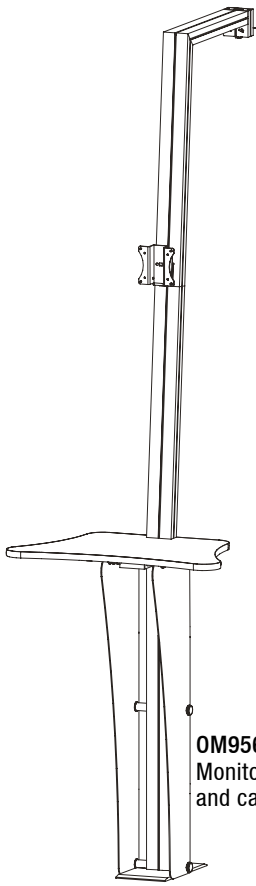

OM9560
Monitor bracket
and case included

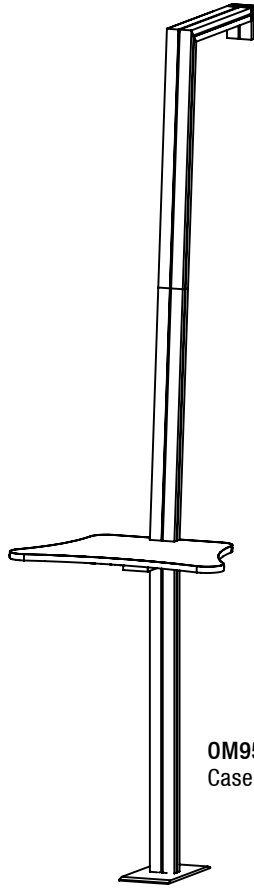

OM9561
Case included

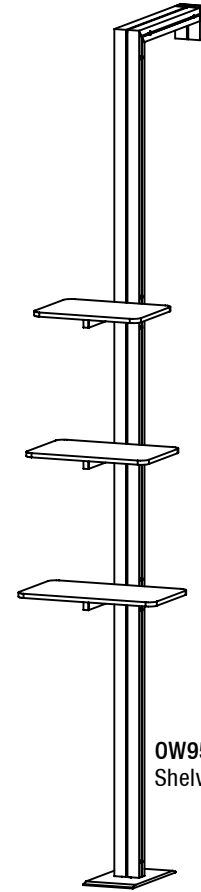

OW9562
Shelves and case included

TECHNICAL INFORMATION

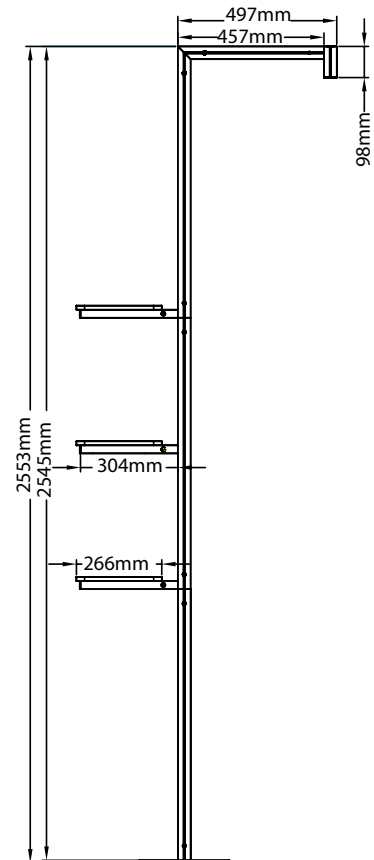
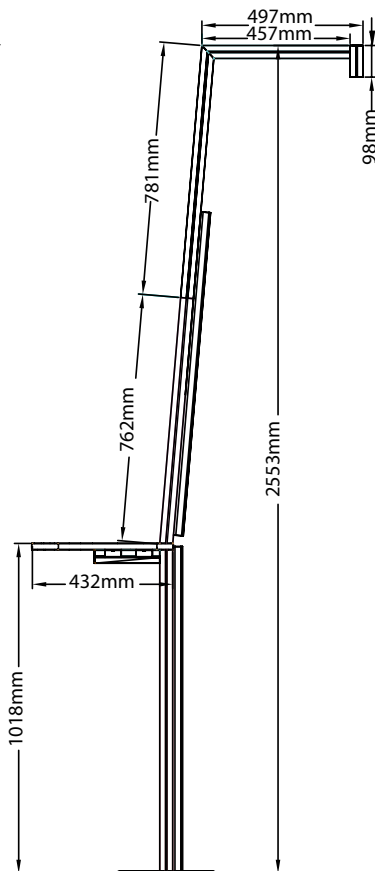
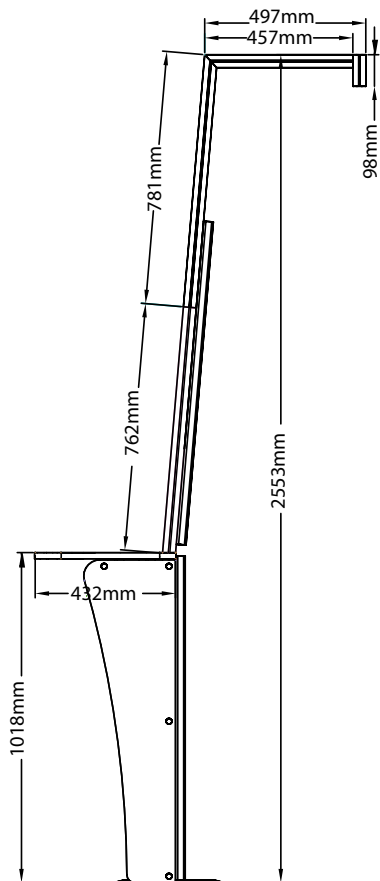

MAGNETIC FIXTURES

Our universal magnetic wall systems allows for mounting a variety of faceouts, shelves, and literature holders to tension fabric with bracing possibilites for large format and single and double sided uses. Sturdy framework and steel plates allow variable fixture locations. The system is ideal as a free standing display and to enhance retail environments.



Design example: Individual part list on request



Base plate M1953



text



LED arm light VA5021



MF21.41
Single hook
80 mm



MF233S.41
Display ring
250 mm



MF202S.41
Faceout/sloped
200 mm



MF204S.41
Faceout/straight
200 mm



MF207S.41 100 mm
MF209S.41 200 mm
Single hook



MF226S.41
Looped hook
200 mm

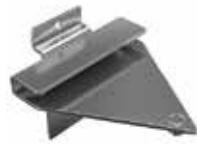

MF306S.41
Bracket, straight
200 mm



MF1.90
Tool



MF125G.51 125 x 250 mm
MF150G.51 150 x 300 mm
Acrylic glass shelf



MF125P.30 125 x 250 mm
MF150P.30 150 x 300 mm
Wood shelf



MF64.51
Literature holder



MF60.51
Literature holder

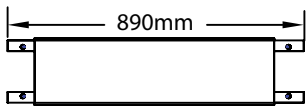

MF82/890
Steelplate and horizontals

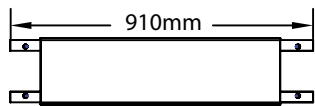

MF82/910
Steelplate and horizontals



MAGNETIC WALL RETAINER

MF15.90 Round magnets 15
Max distribution load 5kg

MF12.90 Round magnets 12
Max distribution load 3kg

MF4.90 Round magnets 4
Max distribution load 0.5kg

MF4400/1182
Upright for Internal structure



TECHNICAL INFORMATION

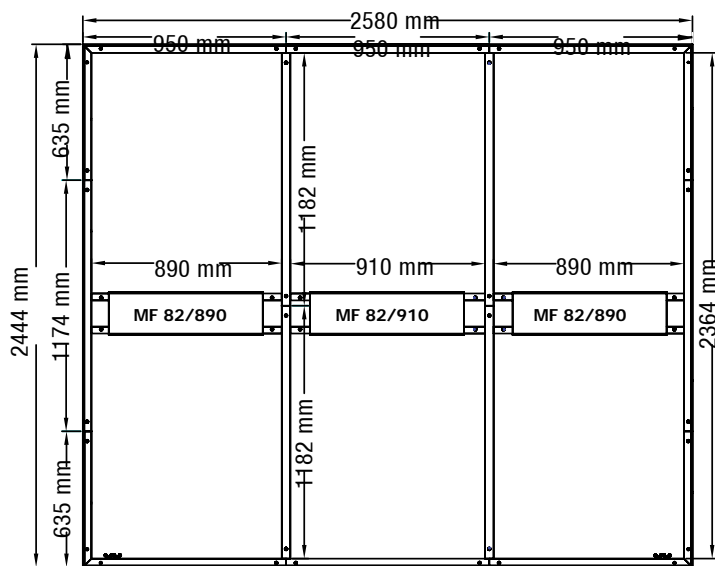
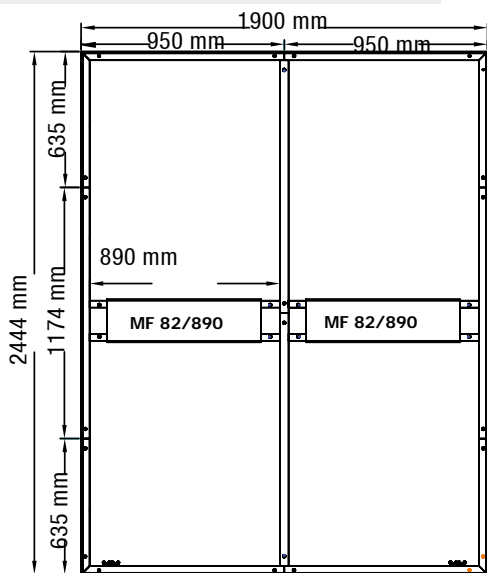

RETURN WALLS



Design example: Individual part list on request



Short, side panel



LED arm light VA5021



Tall, side panel

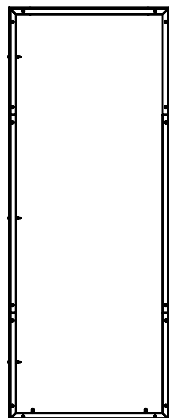

OM9100
Return wall, fabric
950 x 2444 mm

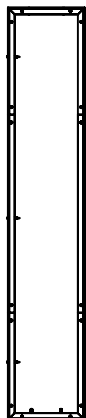

OM9101
Return wall, fabric
455 x 2444 mm

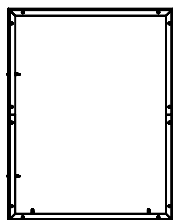

OM9102
Return wall, fabric
950 x 1222 mm



OM992
Connecting post
40 x 2444 mm



OM994
Hinged, connecting post
40 x 1222 mm (x2)

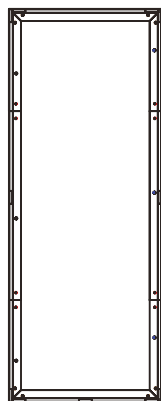

OW9100
Return wall, panel
950 x 2444mm



OW9101
Return wall, panel
455 x 2444mm

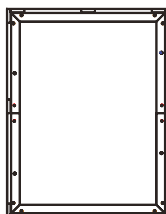

OW9102
Return wall, panel
950 x 1222mm



OM993
Connecting post
40 x 1222m



OM995
Hinged, connecting post
40 x 1222mm (x2)

TECHNICAL INFORMATION

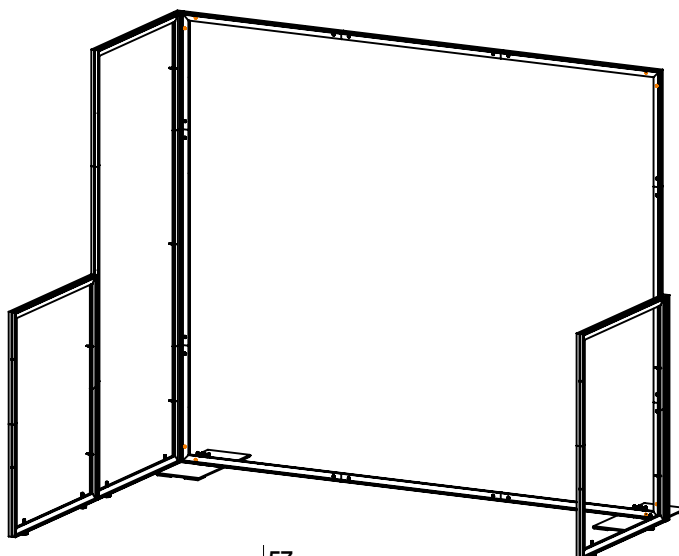

TRANSPORT CASES



VA8056
Roto-molded hard case,
980 x 675 x 455 mm
black



OP950
Roto-molded hard case,
two built in wheels,
molded-in handle
1346 x 381 x 197 mm
black



VA6310
Roto-molded case, two built-in wheels,
molded-in handle and telescoping lid
1295 x 686 x 254 mm
gray



VK6309
Roto-molded case from rugged polyethylene,
two wheels for easy movement,
two heavy duty web straps with quick release buckles,
molded-in handles,
telescoping lid
1143 x 838 x 279 mm
gray

A large grid of small dots for writing cases, covering most of the page.

exhibition systems
interior design systems
presentation systems
cleanroom systems
software and service

WAY BEYOND THE NORM: DISPLAY AND PRESENTATION SYSTEMS FROM OCTANORM.

We are here if you have any questions. Would you like a quotation? More information? An appointment? We look forward to your call, your query and you! Welcome to OCTANORM!

AW 6600.USA-03/2015

THE
WORLD
OF
SYSTEMS

www.octanormusa.com

OCTANORM 